

Electric Heater Steam Humidifier StandardLine

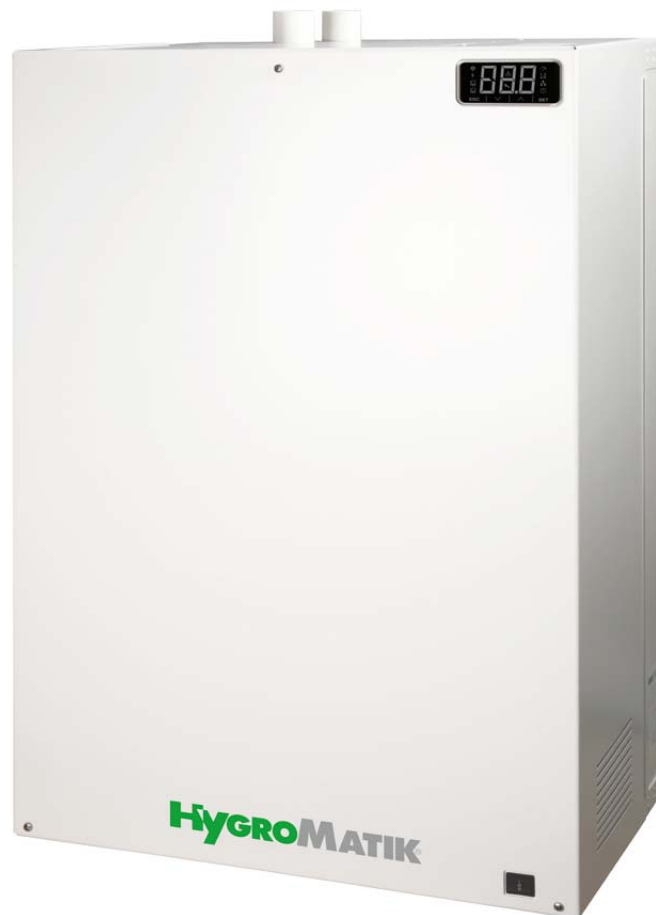

**IMPORTANT: READ AND SAVE
THESE INSTRUCTIONS**

Certain computer programs contained in this product [or device] were developed by HygroMatik GmbH ("the Work(s)").

Copyright © HygroMatik GmbH [31.01.2019]

SLH 03/06/09/15/25/40/50

All Rights reserved.

Current version of this manual to be found on: www.hygromatik.com

HygroMatik GmbH grants the legal user of this product [or device] the right to use the Work(s) solely within the scope of the legitimate operation of the product [or device]. No other right is granted under this licence. In particular and without prejudice to the generality of the foregoing, the Work(s) may not be used, sold, licensed, transferred, copied or reproduced in whole or in part or in any manner or form other than as expressly granted here without the prior written consent of HygroMatik GmbH.

Information in this manual is subject to change or alteration without prior notice.

▲WARNING

Risk of electrical shock!

Hazardous electrical voltage!

All electrical work to be performed by certified expert staff (electricians or expert personnel with equivalent training) only.

1. Introduction	6
1.1 Typographic Distinctions	6
1.2 Documentation	6
1.3 Symbols in Use	6
1.3.1 Specific Symbols related to Safety Instructions	6
1.3.2 General Symbols	6
1.4 Intended Use	7
2. Safety Instructions	8
2.1 Guidelines for Safe Operation	8
2.1.1 Scope	8
2.1.2 Unit control	8
2.1.3 Unit Operation	8
2.1.4 Mounting, dismantling, maintenance and repair of the unit	9
2.1.5 Electrical	9
2.2 Disposal after dismantling	9
3. Transport	10
3.1 Overview	10
3.2 Packing	10
3.3 Interim Storage	10
3.4 Check for Complete and Correct Delivery of Goods	10
4. Functional Description and Device Composition	11
4.1 Mode of Action	11
4.2 Operational sequence	12
4.3 Internal Output Setting	12
4.3.1 Continous control	12
4.3.2 Combination of 1-step switching and continous control	12
4.4 Mechanical Construction	12
5. Mechanical installation	13
5.1 Environment Parameters to be met and Mounting Recommendations	13
5.1.1 Dimensions and Mounting Directions	14
5.2 Unit Installation Check	17
5.3 Absorption Distance BN	18
5.3.1 Determining the Absorption Distance	18
5.3.2 Absorption Distance Nomogram	19
5.4 Steam Manifold	20
5.4.1 General installation guidelines	20
5.4.2 Recommendations for dimensioning	20
5.5 Steam line and condensate hose layout	23
5.5.1 Guide lines for steam line design	23
5.5.2 Condensate hose layout	23
5.5.3 Steam line and condensate hose installation types	24
6. Water connection	25
6.1 Water supply	25

6.2 Water discharge	26
6.3 Water connections final check	27
7. Electrical connection	28
7.1 Electrical installation approach	28
7.2 Cable connections	29
7.3 Safety interlock	30
7.4 Control signal	30
7.4.1 1-step operation	30
7.4.2 Operation with an active humidity sensor or external controller	30
7.4.3 Wiring for control signal and safety (interlock) system for multiple devices	31
7.5 Connection diagram	31
7.6 Electrical installation check list	31
8. Commissioning	32
9. Maintenance	33
9.1 General	33
9.1.1 Safety instructions for maintenance	33
9.2 Maintenance frame work when unit is operated with fully demineralised water and condensate	34
9.3 Maintenance when unit is operated with tap water or partially softened water	34
9.4 Removing and cleaning the steam cylinder	35
9.5 Steam cylinder and cylinder base cleaning	39
9.6 Level control device cleaning	40
9.7 Heater element replacement	41
9.8 Thermo switch replacement (for heater elements)	41
9.9 Releasing a thermo switch that has triggered	42
9.10 Inspection of wiring connections and heater element wiring	42
9.11 Removal and reinstallation of the solenoid valve including fine filter cleaning	43
9.12 Cleaning of blow-down pump	44
9.13 Inspection of hoses	44
9.14 Functional check	44
10. Dismantling	45
11. Unit Control	46
11.1 General description	46
11.1.1 Wiring Diagrams	48
11.1.2 Mainboard inputs and outputs	52
11.2 Control operation	53
11.2.1 Principal user guidance	53
11.2.2 Menu structure	53
11.2.3 Menu tree	54
11.3 The control panel	55
11.4 Navigation within a menu	56
11.5 Tabular representation of reading value list and provider level submenus	57
11.5.1 The reading value list	57

11.5.2 Provider level submenus and relating parameters	58
11.6 Exemplary variation of a parameter setting	61
11.7 Detailed description of the user level reading values and settings	62
11.8 Detailed parameter descriptions	65
12. Trouble shooting	71
12.1 Error handling	71
12.1.1 Table of possible faults and related error codes	71
12.2 Table of functional disruptions	76
13. Declaration of conformity	78
14. Spare Parts	79
15. Technical specifications	81
16. Exploded view	84
17. View of housing	85

1. Introduction

Dear Customer,

Thank you for choosing a HygroMatik steam humidifier.

HygroMatik steam humidifiers represent the latest in humidification technology.

In order to operate your HygroMatik steam humidifier safely, properly and efficiently, please read these operating instructions.

Employ your steam humidifier only in sound condition and as directed. Consider potential hazards and safety issues and follow all the recommendations in these instructions.

If you have additional questions, please contact your expert dealer.

For all technical questions or spare parts orders, please be prepared to provide unit type and serial number (see name plate on the unit).

1.1 Typographic Distinctions

- preceded by a bullet: general specifications
- » preceded by an arrow: Procedures for servicing or maintenance which should or must be performed in the indicated order
- ☑ Installation step which must be checked off.

italics Terms used with graphics or drawings

1.2 Documentation

Please note

In addition to this manual, the appropriate FlexLine Control documentation is mandatory for the operation of the unit.

Retention

Please retain these operating instructions in a secure, always accessible location. If the product is resold, turn the documentation over to the new operator. If the documentation is lost, please contact HygroMatik.

Versions in Other Languages

These operating instructions are available in several languages. If interested, please contact HygroMatik or your HygroMatik dealer.

1.3 Symbols in Use

1.3.1 Specific Symbols related to Safety Instructions

According to EN 82079-1 (and ANSI Z535.6), the following signal words are used within this document:

▲ DANGER

DANGER indicates a hazardous situation which, if not avoided, will result in death or serious injury.

▲ WARNING

WARNING indicates a hazardous situation which, if not avoided, could result in death or serious injury.

▲ CAUTION

CAUTION indicates a hazardous situation which, if not avoided, could result in minor or moderate injury.

NOTICE

NOTICE is used to address practices not related to physical injury.

1.3.2 General Symbols

Please note

This symbol is used whenever a situation requires special attention beyond the scope of safety instructions.

1.4 Intended Use

HygroMatik electric heater steam humidifiers serve for steam production based on tap water, partially softened water or fully desalinated water/cleaned condensate.

Proper usage also comprises the adherence to the conditions specified by HygroMatik for:

- installation
- dismantling
- reassembly
- commissioning
- operation
- maintenance
- disposal.

Only qualified personnel may operate the unit. Persons transporting or working on the unit must have read and understood the corresponding parts of the Operation and Maintenance Instructions and especially the chapter 2. „Safety Notes“.

Additionally, operating personnel must be informed of any possible dangers by the provider. A copy of this manual is to be placed at the unit's operational location.

By construction, HygroMatik steam humidifiers are not qualified for exterior application.

▲ WARNING

Risk of scalding!

Steam with a temperature of up to 100 °C (212 °F) is produced.

Do not inhale steam directly!

2. Safety Instructions

These safety instructions are required by law. They promote workplace safety and accident prevention.

2.1 Guidelines for Safe Operation

2.1.1 Scope

Comply with the accident prevention regulation „DGUV Regulation 3“ to prevent injury to yourself and others. Beyond that, national regulations apply without restrictions.

2.1.2 Unit control

Do not perform any work which compromises the safety of the unit. Obey all safety instructions and warnings present on the unit.

In case of a malfunction or electrical power disruption, switch off the unit immediately and prevent a restart. Repair malfunctions promptly.

⚠ WARNING

Restricted use.

IEC 60335-1 stipulates as follows:

This device may be used by children of eight years of age and above as well as by persons with reduced physical, sensory or mental capabilities or lack of experience and knowledge so long as they are supervised or have been instructed regarding the safe use of the device and understand the hazards that may result from it. Cleaning and user maintenance of the unit must not be undertaken by children without supervision.

2.1.3 Unit Operation

⚠ WARNING

Risk of scalding!

Uncontrolled hot steam escape in case of leaking or defective components possible. Switch off unit immediately.

NOTICE

Risk of material damage!

The unit may be damaged if switched on repeatedly following a malfunction without prior repair.

Rectify defects immediately!

The unit must not be operated on a DC power supply.

The unit may only be used connected to a steam pipe that safely transports the steam.

Regularly check that all safety and monitoring devices are functioning normally. Do not remove or disable safety devices.

2.1.4 Mounting, dismantling, maintenance and repair of the unit

NOTICE

The HygroMatik steam humidifier is IP20 protected. Make sure that the unit is not object to dripping water in the mounting location.

Installing a humidifier in a room without water discharge requires safety devices to protect against water leakages.

- Use genuine spare parts only
- After any repair work, have qualified personnel check the safe operation of the unit
- Attaching or installing of **additional components** is permitted only with the **written consent** of the manufacturer

2.1.5 Electrical

⚠ WARNING

Risk of electrical shock!

Hazardous electrical voltage!

Any work on the electrical system to be performed by certified expert staff (electricians or expert personnel with comparable training) only.

Disconnect unit components from electrical power supply prior to work.

After electrical installation or repair work, test all safety mechanisms (such as grounding resistance).

NOTICE

Use only original fuses with the appropriate amperage rating.

Regularly check the unit's electrical equipment. Promptly repair any damage such as loose connections or burned wiring.

Responsibility for intrinsically safe installation of the HygroMatik steam humidifiers is incumbent on the installing specialist company.

2.2 Disposal after dismantling

NOTICE

The operator is responsible for the disposal of unit components as required by law.

3. Transport

3.1 Overview

Please note

Proceed carefully when transporting the steam humidifier in order to prevent damage due to stress or careless loading and unloading.

3.2 Packing

Please note

Pay attention to the icons affixed to the packing box.

3.3 Interim Storage

Store the unit in a dry place and protect from frost and strong sunlight.

3.4 Check for Complete and Correct Delivery of Goods

Upon receipt of the unit, confirm that:

- model and serial number on the name plate match those specified in the order and delivery documents
- the equipment is complete and all parts are in perfect condition

Please note

In case of damage from shipment and/or missing parts, immediately notify the carrier or supplier in writing.

Time limits for filing freight claims with shipping companies are*:

Shipping company	After receipt of goods
Carriers	no later than 4 days
Parcel service	immediately

* Time limits for some services subject to change.

4. Functional Description and Device Composition

4.1 Mode of Action

The immersion heater principle

Depending on the output rating, up to six heater elements are arranged within a closed cylinder. Exemplary given, the figure below shows the heater element and other main components of the SLH09 steam generator model.

The cylinder(s) are filled with either tap water of varying quality, fully desalinated water or partially softened water. The heat introduced by the heater element(s) heats up the cylinderwater to approx. 100 °C, transforming the water into steam with a temperature of approx. 100 °C and very little positive pressure (so called pressureless steam). This steam is virtually mineral-free and germ-free.

When fully desalinated water is used, the cylinder water is almost totally clear of minerals. This situation guarantees a long lifetime of the cylinder(s) and the heater element(s), since virtually no hardeners will fall-out and no mineral deposits will occur. Such, the number of inspections and/or maintenance operations required will be reduced to a minimum.

When tap water is used for operation, some of the minerals dissolved in the water are likely to settle in the cylinder in form of solids of various compositions. However, most of the solids are flushed out by cyclic blow-down with the help of a heavy-duty blow-down pump.

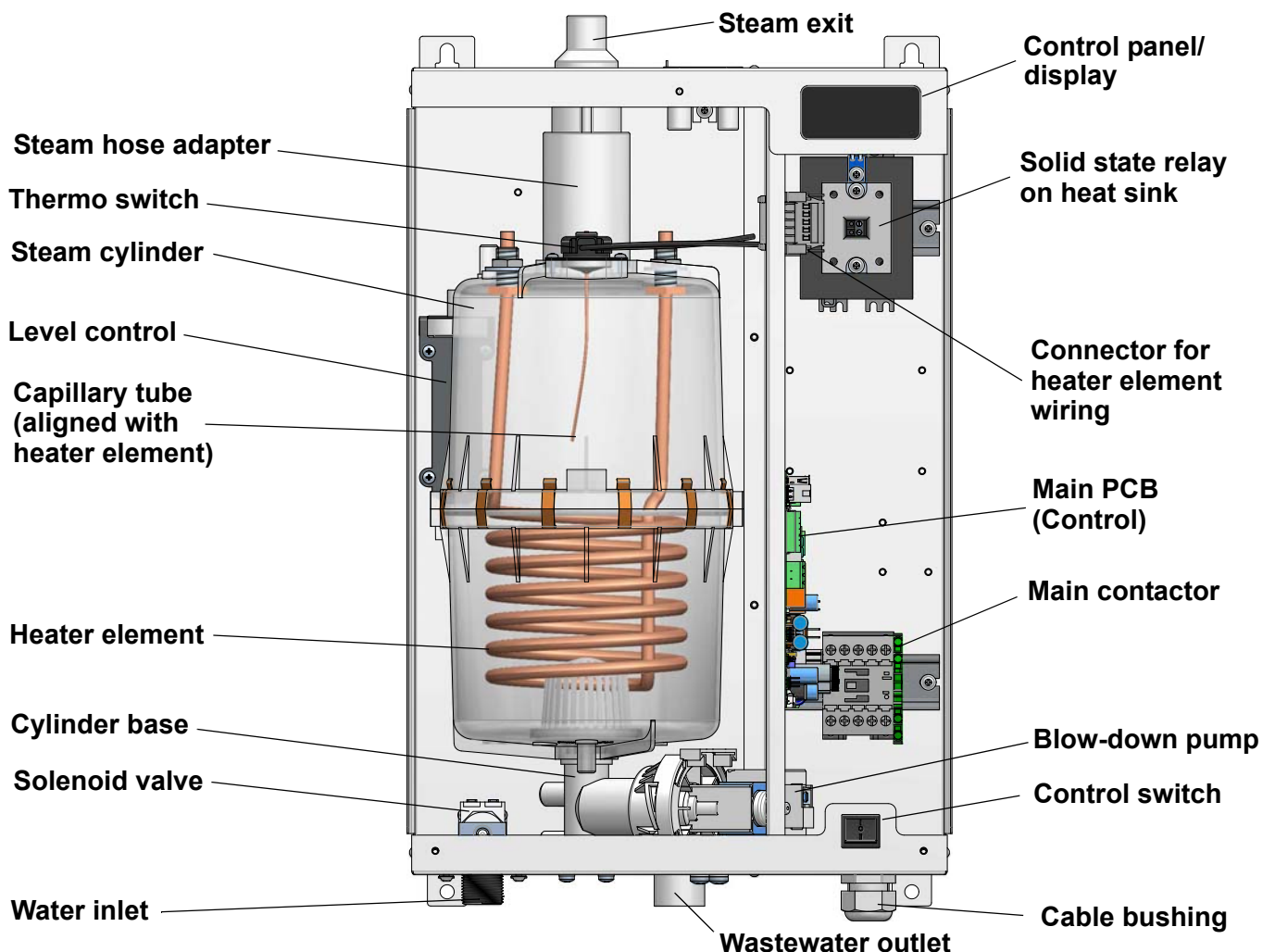

4.2 Operational sequence

The steam humidifier is switched on by pressing the control switch on the front panel to the „I“ position. When a demand for humidification is signalled by a hygrostat, a humidity sensor or an external controller (depending on the implementation), the inlet solenoid valve (25)* opens and water is fed into the steam cylinder.

Filling level in the cylinder is controlled by a level control device (27)*. In a plastic cylinder, connected to the steam cylinder via hoses in the way communicating tubes are connected, a sensor for continuous proportional water level survey is located.

The cylinder water is periodically blown down. For usage of the unit with fully desalinated water, the blow-down function may be blocked.

Water blow-down is achieved by means of the blow-down pump (32)* that is continuously monitored during unit operation. In case of pump disruption, the HygroMatik steam humidifier is shut off.

With normal water quality, blow-down loss is in the range of 7 to 15% of the steam amount produced. Depending on water quality, a full steam cylinder blow-down is run every 3 to 8 days.

Mineral deposits settle in the open area below the heater element(s) and are removed through periodic maintenance. The blow-down pump itself has wide openings and can flush out smaller pieces of mineral deposit. This extends the service life of the unit and reduces the required maintenance interval.

On blow-down, water flows from the pump into the drain hose system.

For maintenance purposes, the cylinder water may be pumped out by pressing and holding the control switch in the „II“ position.

*) numbers indicated correspond with those in the exploded view in the „Exploded view“ chapter.

4.3 Internal Output Setting

4.3.1 Continuous control

for units with 1...3 heater elements

Continuous control is achieved by proportional driving (pulse width modulation) of the heater elements. In this way the humidifier can be proportionally operated across the entire output range of 5% - 100% of the nominal capacity.

4.3.2 Combination of 1-step switching and continuous control

for units with 6 heater elements

If the humidifier features more than 3 heater elements, service provision is accomplished in 2 steps. As long as a certain threshold is not reached, the heating power demanded is delivered exclusively via the solid state relay and 3 heater elements by using continuous control (stage 1). If the output power demand exceeds the power available in stage 1, 3 more heater elements are additionally switched on in a 1-step mode (stage 2). The power demand beyond what is available in stage 2 is then covered in stage 1 by the solid state relay driven in proportional mode.

4.4 Mechanical Construction

The StandardLine heater steam humidifiers are designed for wall mounting.

5. Mechanical installation

▲ WARNING

Risk of foot injuries!

Prevent unit from dropping during installation! Helping hand of a second person is advisable.

▲ WARNING

Risk of electrical shock!

Hazardous electrical voltage. During installation, the unit must be disconnected from power supply.

5.1 Environment Parameters to be met and Mounting Recommendations

When selecting the installation site for the steam humidifier, take the following into account:

- The minimum clearances indicated in the fitting measures section must be observed in order to ensure adequate unit ventilation and allow for unobstructed access in case of maintenance
- Protection class IP20
- By design, HygroMatik steam humidifiers are not qualified for outdoor installation (electronical components and water-bearing parts may be damaged)
- Ambient temperature must lie between +5 and +40 °C (+41 and +104 °F) in order to protect the unit electronics against damage; frost may damage the steam cylinder, the solenoid valve and pump, as well as make hoses burst
- Relative humidity must not exceed 80 % r.h., since values beyond may lead to electronic malfunction or damage

- Installation in a closed room requires aeration and, eventually, temperature conditioning in order to meet the a.m. environmental conditions
- The steam humidifier should be installed as close as possible to the steam manifold. Optimum performance is only guaranteed when steam and condensate hoses are kept short
- Make use of existing water connections for supply and draining
- Hoses must be laid at a consistent 5 to 10 % incline/decline; sagging and kinking prevention is a must
- Mount the unit on a stable, preferably solid wall offering the bearing capacity required (s. unit technical specifications). If such a wall is not at hand, the unit may be attached to a stand bracket firmly bolted to the floor
- For proper functioning of the level control, plumb and level installation of the unit is required
- The steam humidifier rear panel heats up during operation to a maximum of 70 °C (158 °F). Take care that the construction on which the unit is to be mounted is not made of temperature-sensitive material

5.1.1 Dimensions and Mounting Directions

Table of dimensions

Model	X [mm/inch]	Y [mm/inch]	Z [mm/inch]	A [mm/inch]	B [mm/inch]
SLH03-SLH09	350/~13.8	535/~21	245/~9.6	295/~11.6	535/~21
SLH15-SLH25	425/~16.7	695/~27.4	320/~12.6	370/~14.6	695/~27.4
SLH40-SLH50	590/~23.2	790/~31.1	415/~16.3	535/~21	787/~31

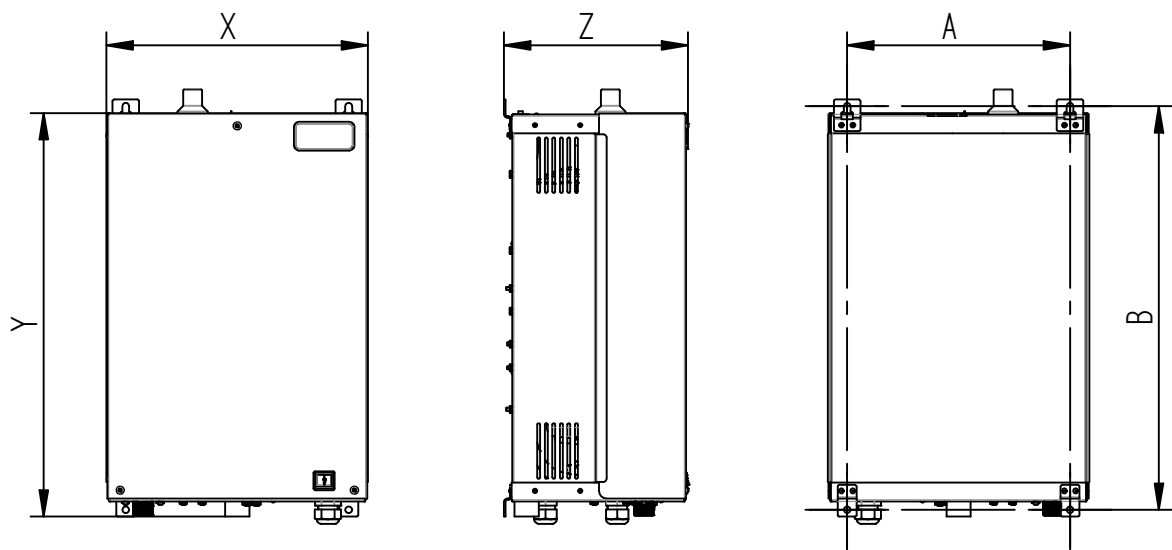

Detailed easurements under

<https://www.hygromatik.com/files/pdf/hygromatik-standardline-dimensionsv11.pdf> .

3D models under <https://www.hygromatik.com/en/downloads>

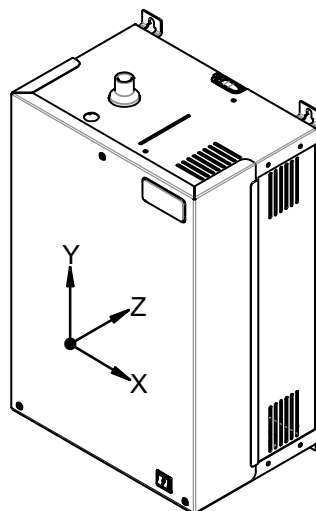

Wall clearances

When mounting the steam humidifier, the wall clearances shown in the fig. below must be obeyed:

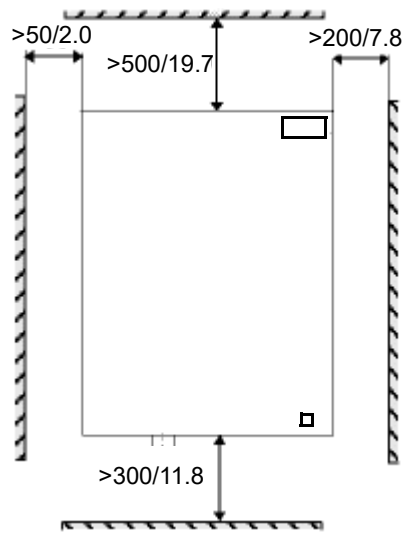

all measures in mm/inch

Mounting principle

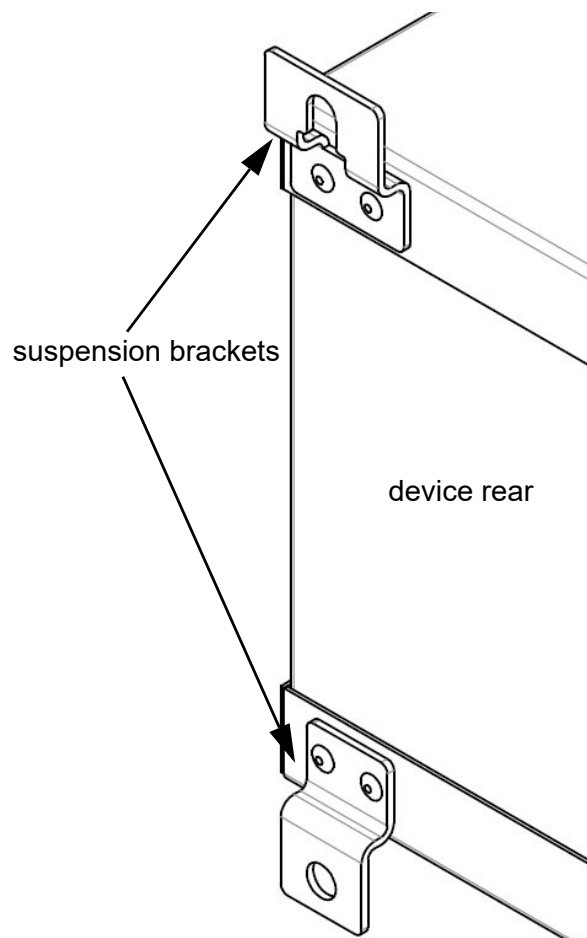

For wall mounting drill measures, please consult the table above (measure A). In case of no suitable wall available for mounting the unit, it is recommended that installation is made on brackets firmly anchored in the floor.

- » mark the holes for the upper suspension brackets screws
- » drill holes and dowel
- » screw in the supplied mounting screws; let the screws protrude approx. 12 mm/.5 inch from wall
- » ensure firm fixation and load-carrying capacity of the mounted screws!
- » hook in the unit and ensure safe suspension
- » mark the holes for the lower suspension brackets screws
- » remove the unit
- » drill holes and dowel
- » hook in the unit and mount the lower screws firmly

To function properly, the steam humidifier must hang level and plumb.

Device connections:

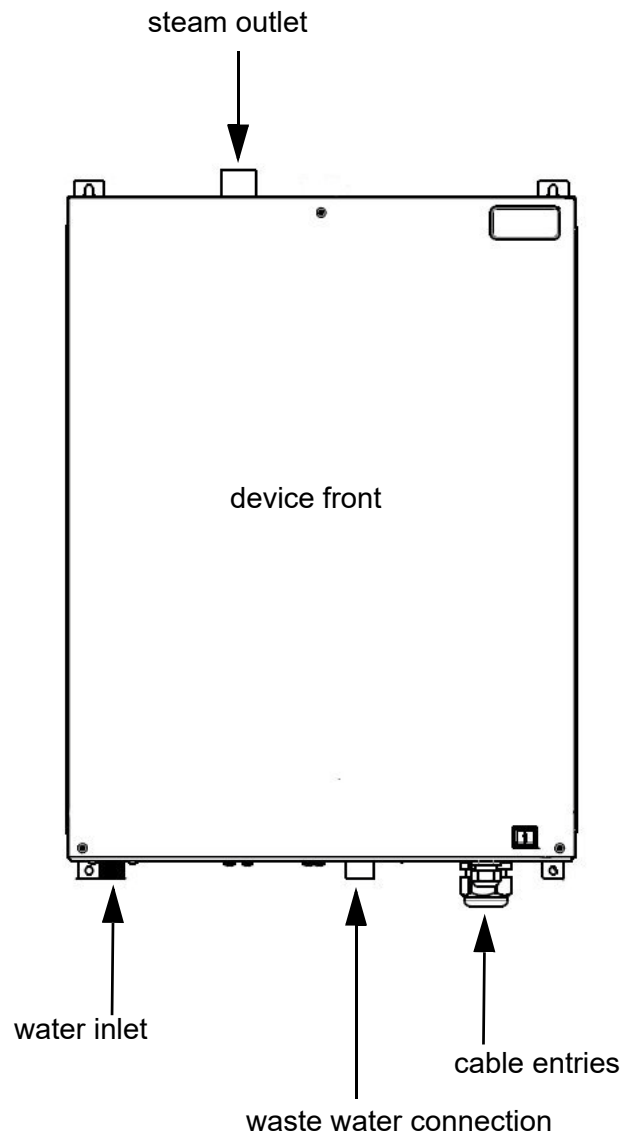

5.2 Unit Installation Check

Before start-up, pls. check proper unit installation following the list below:

- Unit perpendicularly aligned in both the vertical and horizontal axis ?
- All clearances obeyed?
- Steam hose installed with a 5 - 10 % minimum incline/decline (see chapter "Steam line") ?
- Condensate hose features a loop functioning as a steam barrier (see chapter „Condensate hose“) ?
- Steam manifold(s) properly positioned?
- All bolts and clamps properly tightened?
- Steam manifold(s) horizontally mounted and suspended on the free end, if required ?
- All seals (o-rings) in place?
- All ventilation slots on housing top unobscured?

5.3 Absorption Distance B_N

The "absorption distance" (B_N) is defined as the distance from the steam feed to where the steam is completely absorbed in the treated air. Within the absorption distance, steam is visible as mist in the air stream.

Condensation may occur on anything installed within the absorption distance.

Although steam outside the absorption distance (B_N) is completely absorbed, it is not yet evenly diffused in the duct. If you plan to install any parts or devices inside the absorption distance, such as sensors or elbows, we recommend increasing the absorption distance using the formulae below. The absorption distances required for certain installed fittings are distinguished by separate symbols and calculated as a multiplier of the absorption distance B_N .

Absorption Distance	
B_N	for normal obstructions such as sensors, ventilators, outlets
$B_C = (1.5...2) \times B_N$	for fine filters, heat registers
$B_S = (2.5...3) \times B_N$	for particle filters
$B_d = (3...5) \times B_N$	for humidity sensors, duct humidistats

The absorption distance has no fixed value, but depends on many factors. These are depicted in the absorption distance nomogram below.

5.3.1 Determining the Absorption Distance

To determine the absorption distance, the following parameters are required:

- Air humidity before humidification x_1 in g/kg
- Air temperature after humidification t_2 in °C (with steam humidifiers the change in air temperature due to humidification may be disregarded t_1 or t_2)
- Specific increase in humidity Δx in g/kg (can be determined in the h,x diagram)

- quantity of steam introduced m_D^o in kg/h.
- air speed w_L in m/s in air duct
- Total length l_D of the steam manifold installed in the air duct

Length l_D of the usable steam manifold depends on the dimensions of the air duct. The length of the absorption distance can be reduced by using multiple steam manifolds (also see section on the steam manifold).

Method:

Graphically determine absorption distance B_N using the absorption distance nomogram (also see Section „Absorption Distance Nomogramm“). Enter the value of the parameters enumerated above into the respective quadrants. The resulting point of intersection indicates the value of the desired absorption distance B_N .

Notes:

- Air humidity before humidification x_1 :.....[g/kg]
- Air temperature after humidification t_2 :.....[°C]
- Specific increase in humidity Δx :.....[g/kg]
- Quantity of steam introduced m_D^o :.....[kg/h]
- Air speed w_L :.....[m/s]
- Total length of steam manifold l_D :.....[mm]

5.3.2 Absorption Distance Nomogram

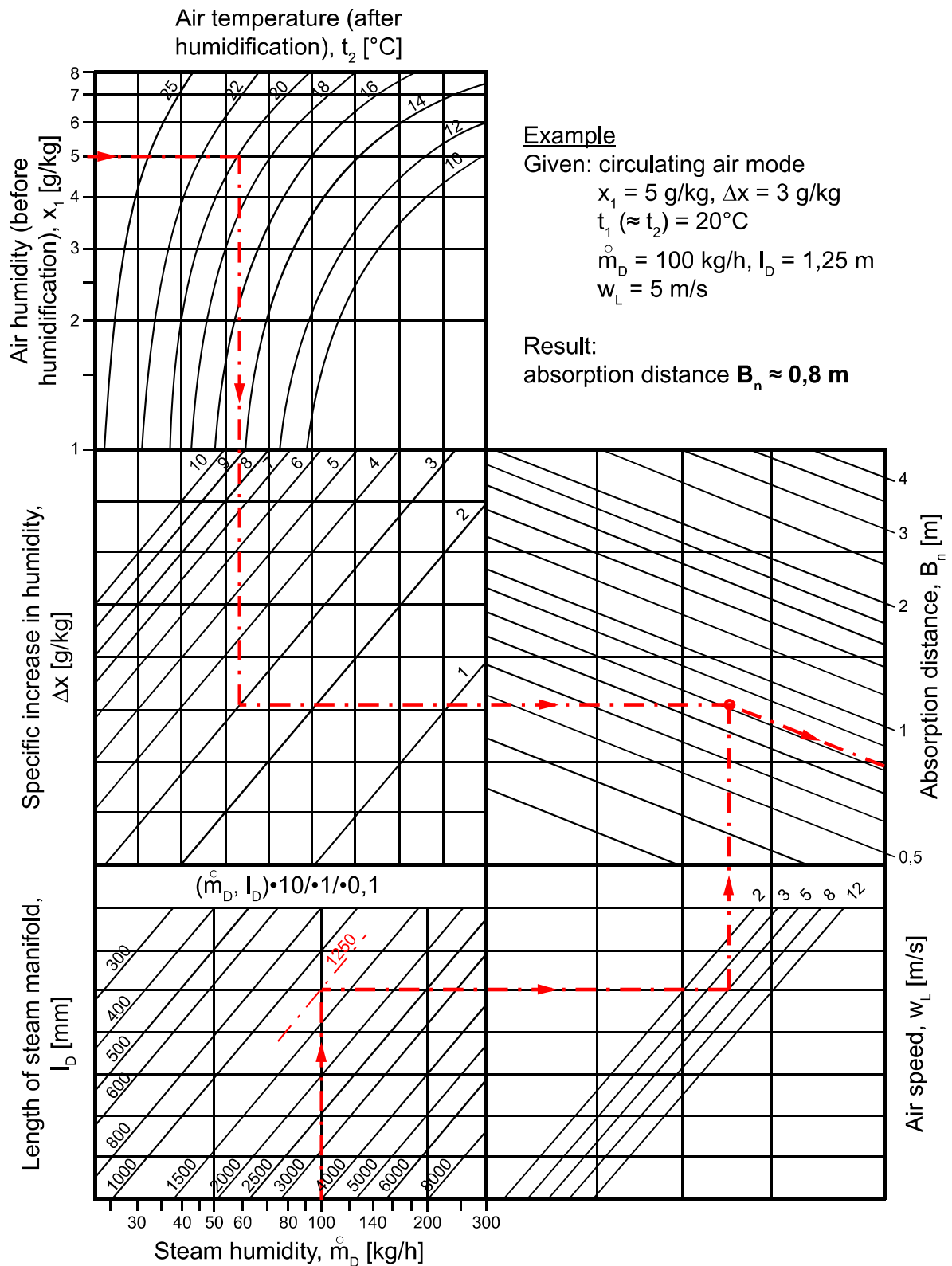

Source: Henne, Erich: Luftbefeuchtung (Air Humidification), 3rd Edition 1984 (Page 101), Oldenbourg Industrieverlag, Munich

5.4 Steam Manifold

5.4.1 General installation guidelines

When installing steam manifolds, pls. follow these guidelines:

Positioning within duct

- Install the steam manifold as close as possible to the steam humidifier in order to minimize steam loss through condensation
- Steam manifold placement on the supply side of the air duct is preferable
- Install steam manifold strictly horizontal in order to ensure proper condensate drain
- Shown installation and positioning dimensions are based on empiric values. Special environmental conditions may require adjustments. Pay special attention to avoid condensate generation in air duct

Allowable pressures

- Max. allowable pressure in air duct is 1500 Pa/.218 PSI (exemption: SLE02 only allows for 1200 Pa/.174 PSI)
- On suction side, max. -500 Pa (.07 PSI) is tolerable
- With high-pressure air conditioning systems, modifications of the unit's drain hose system may possibly be required depending on the overall pressure situation. These modifications must be **coordinated with your expert dealer.**

Water drain

- We point out that according to the German Association of engineers (VDI) guideline VDI 6022, a water drain must be provided within the absorption distance inside the air duct

When increased airflow speed is encountered

- Air flow rates beyond 3m/s (9.84 ft/s) may lead to condensate drainage problems at the steam manifolds due to vacuum built-up. A possible remedy is twisting the steam manifold in its horizontal axis by few angular degrees. In case of problems, pls. consult your expert dealer.

5.4.2 Recommendations for dimensioning

The recommendations given below are based on homogenous air flow in the duct.

Horizontal installation of steam manifold

Standard steam manifold arrangement:

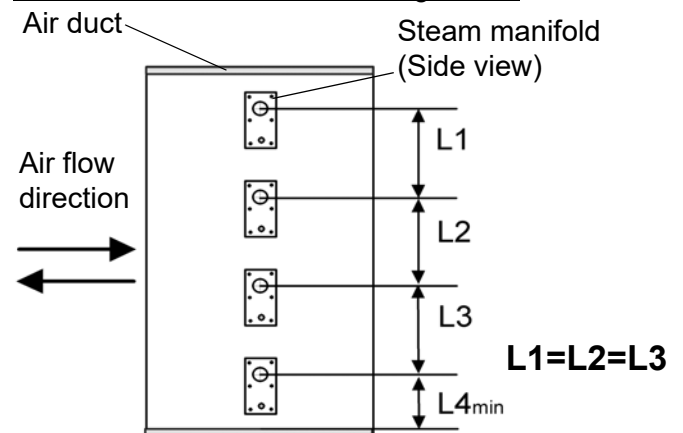

An even distribution of steam manifolds ensures a uniform steam distribution.

Please use the total height of the duct!

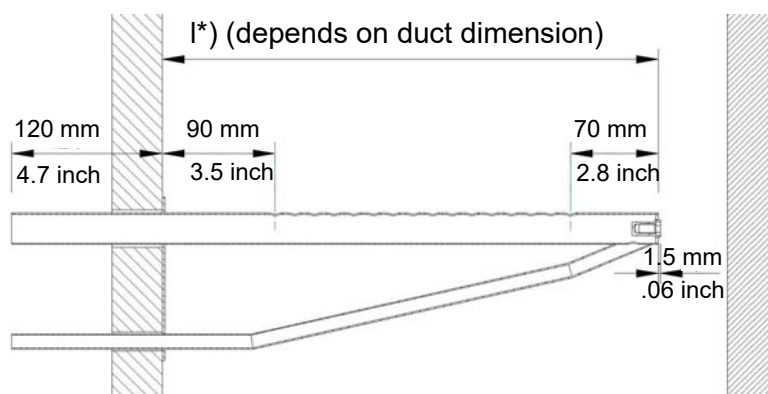

*) s. table of manifold lengths **Horizontal assembly position in duct**

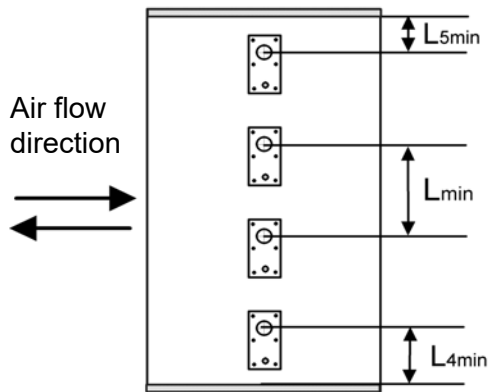

Minimum distance for condensation avoidance:

$L_{min} = 210mm/8.3\text{ inch}$: „Steam manifold - Next steam manifold“ distance

$L_{4min} = 120mm/4.7\text{ inch}$: „Lowest steam manifold - Duct bottom plane“ distance

$L_{5min} = 120mm/4.7\text{ inch}$: „Highest steam manifold - Duct ceiling plane“ distance

Steam manifold arrangement for special air duct shapings

flat	steam manifold laterally staggered (with respect to air flow direction) in case of L_{min} (s. above) not to be met	<p>Air flow direction</p>																
very flat	<p>by tilting the steam manifold 30 - 45° towards the air flow direction, the minimum upper clearance can be reduced to 70 mm/2.8 inch.</p> <table border="1" data-bbox="379 1429 906 1624"> <thead> <tr> <th>Min[mm/inch]</th> <th colspan="2">H1</th> <th>H2</th> </tr> <tr> <td></td> <th>30°</th> <th>45°</th> <td></td> </tr> </thead> <tbody> <tr> <td>DN25/1"</td> <td>182/7.2</td> <td>168/6.6</td> <td>225/8.6</td> </tr> <tr> <td>DN40/1 1/2"</td> <td>193/7.6</td> <td>179/7.2</td> <td>230/9.1</td> </tr> </tbody> </table>	Min[mm/inch]	H1		H2		30°	45°		DN25/1"	182/7.2	168/6.6	225/8.6	DN40/1 1/2"	193/7.6	179/7.2	230/9.1	<p>narrow channel</p> <p>Air flow direction</p>
Min[mm/inch]	H1		H2															
	30°	45°																
DN25/1"	182/7.2	168/6.6	225/8.6															
DN40/1 1/2"	193/7.6	179/7.2	230/9.1															
narrow, high	identical lengths one on top of the other, staggered laterally if possible																	
square	identical lengths, staggered vertically and laterally																	
low, very wide	facing each other																	

Vertical steam manifold installation

Steam manifold arrangement

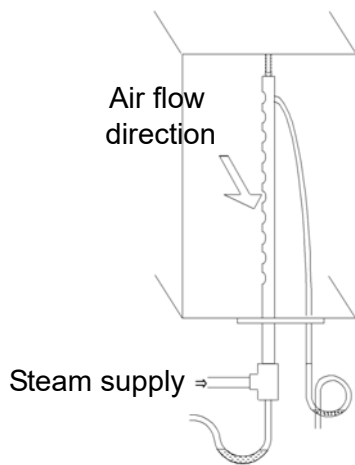

Horizontal installation of the steam manifolds is preferable. However, vertical installation into the air duct from below is also possible.

Standard manifold dimensions [mm]/ [inch]:**

220/	400/	600/	900/	1200/	1450****/
8.7	15.7	23.6	35.4	47.2	57.1

*** Special lengths on demand.

**** will be replaced in 2019 by 1500 mm / 59,1 inch long steam distributors

Number and size of the steam manifolds available as well as the nominal diameter of the respective steam and condensate hoses may be taken from the tables shown in chapter „Technical Data“.

5.5 Steam line and condensate hose layout

Please note

Because of the high requirements on hose material under the operating conditions given, it is recommended to use genuine HygroMatik hoses only.

5.5.1 Guide lines for steam line design

- Steam hose nominal diameter must not be smaller than the steam outlet of the HygroMatik steam humidifier (do not restrict the cross-section, otherwise back pressure will increase)
- Steam hoses must be laid without sags and kinks and with a continuous slope of 5-10% (otherwise sags may result).
- Steam hoses must be supported every 500 mm (20 inches) by clamp brackets
- Steam hoses should be kept as short as possible. Implement lengths beyond 5 m (16 ft.) as insulated fixed piping to keep energy loss and condensate generation to a minimum. Beyond 10 m (32 ft.) insulated installation is a must. Fixed piping is generally recommended for straight steam line segments
- When 2 steam manifolds are in use (other than with a standard implementation), place steam Y piece as close as possible to the steam manifolds. Such, for the main part of the piping just one steam hose is required and condensate loss is minimized
- Allow easy access to the steam pipe/ steam hose installation
- Pressure conditions within the duct are influenced by device steam output, steam line layout and the duct composition itself. In some rare situations it may become necessary to optimize steam line layout for achieving the results intended
- Respect minimum bending radii:

DN 25 Steam hose: Rmin = 200 mm/8"
 DN 40 Steam hose: Rmin = 400 mm/16"

5.5.2 Condensate hose layout

The condensate hose may be run from the steam manifold back to the steam cylinder, as depicted in the schematic drawing below with concern to installation type 1. Alternatively, the condensate hose may be fed directly in a wastewater pipe or a drain (s. installation type 2).

Please note

Should condensate return into the steam cylinder be intended, the connection stub on the cylinder upper part must be drilled out first with a ANSI drill size „O“ drill. To do so, the steam cylinder must be removed from the housing (s. maintenance chapter, section „Steam cylinder removal and reinstallation“).

Drill out condensate hose connection stub with an 8 mm (ANSI drill size „O“) drill, if required

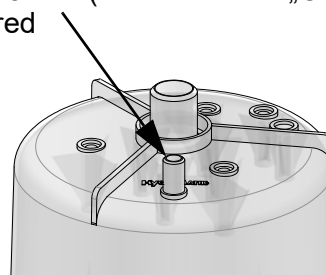

Steam cylinder top view

5.5.3 Steam line and condensate hose installation types

Installation type 1

Steam manifold is positioned more than 500 mm above device upper edge:

- » Run steam hose to a height of 400 mm/16 inch minimum above the steam humidifier and then to the steam manifold with a continuous incline of 5 to 10 %.
- » Feed condensate hose from steam manifold with a decline into waste-water pipe or drain.
- » As a steam barrier, lay out a 200 mm/8 inch min. loop (s. schematic representation below). Minimum distance from steam manifold to loop must be 500 mm/20 inch. Fill loop with water prior to steam humidifier commissioning.

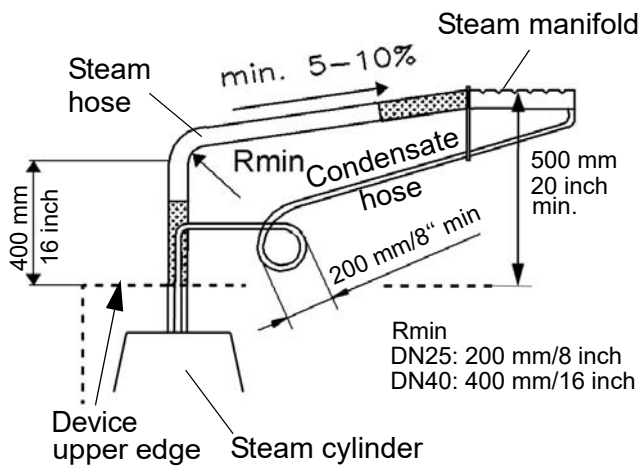

**Installation type 1,
schematic representation**

Installation type 2

Steam manifold is positioned less than 500 mm above or below device upper edge:

Please note

In this arrangement the condensate hose cannot be fed back to the steam humidifier.

- » Run steam hose to a height of 400 mm/16 mm minimum above the steam humidifier and then to the steam manifold with a continuous decline of 5 to 10 %.
- » Feed condensate hose to a waste-water pipe/drain with a 200 mm/8 inch diameter loop as a steam barrier. Minimum distance from steam manifold to loop must be 500 mm/20 inch. Fill loop with water.

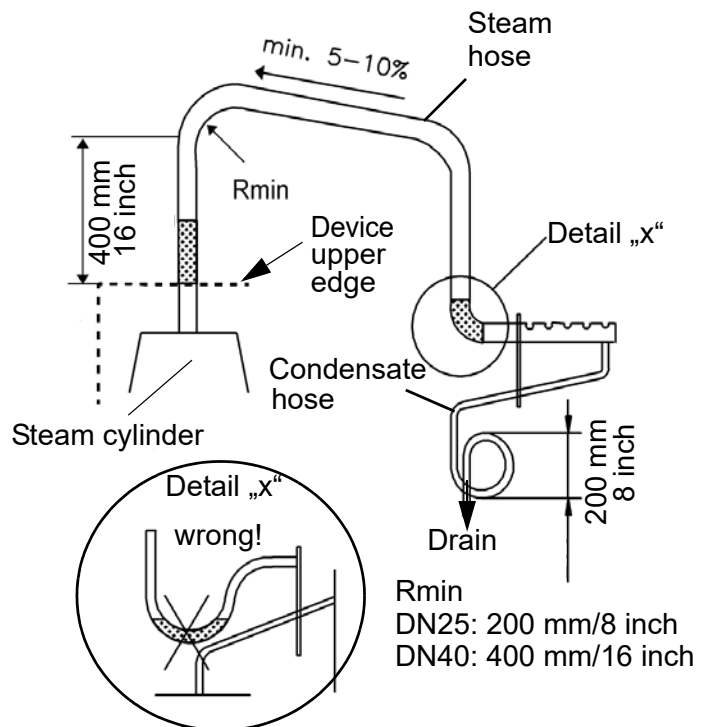

**Installation type 2,
schematic representation**

6. Water connection

▲ WARNING

Risk of scalding!

Very hot water to be found in and around the steam humidifier during and after operation. Have all installation work done by expert staff in order to avoid scalding hazards due to improper water guidance.

▲ WARNING

Risk of electrical shock!

Hazardous electrical voltage!

Before starting installation work ensure that the unit is not yet connected to the power supply.

General Rules

- Obey local water utility regulations
- Verify that necessary safety measures have been taken – in compliance with either German Technical and Scientific Association for Gas and Water (DVGW) guidelines (DIN EN1717) or local regulations – that eliminate backflow of polluted water into drinking water treatment facilities. This may require the installation of a system separator of the CA type (minimum measure, allowable only when free discharge into the drainage system is given). Within the humidifier, a double check valve (58) is located in the water supply line. It prevents - in accordance with DIN EN 61770 - the backflow of water.
- Supply water must not exceed 40 °C
- Allowable range of water pressure: 1 to 10 bar (100×10^3 to 100×10^4 Pa)
- For connection to the water supply pipe, make use of a water hose
- Blow-down water must drain freely
- Min. conductivity of feedwater: 3µS/cm

6.1 Water supply

NOTICE

Foreign material in water supply pipe may cause premature wear of the solenoid valve.

Flush the water supply pipe before making connection to the solenoid valve. This is of particular importance in case of a newly installed pipe.

- » Install a shut-off valve (SV) in the supply line.
- » Install a water filter (WF) if required due to bad water quality.

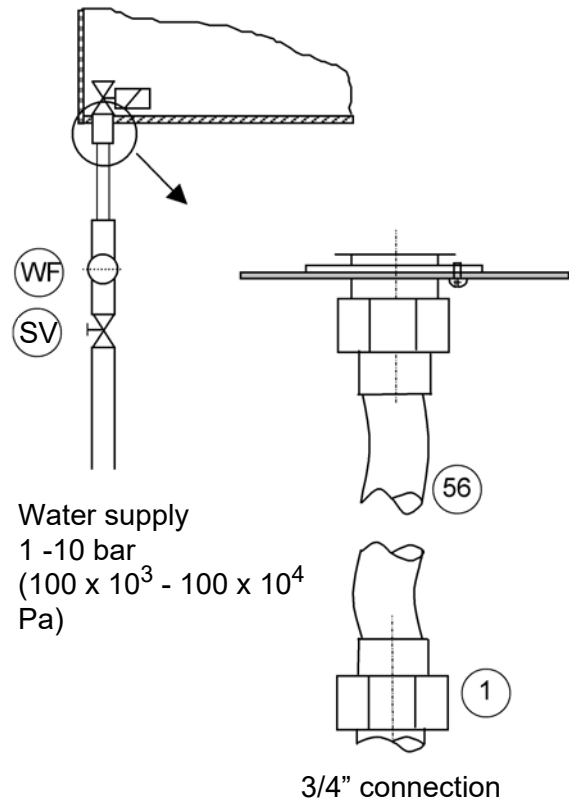

Please note

Shut-off valve (SV) and water filter (WF) are not included in the delivery.

For connection to the water supply line, the water hose (56) with cap nuts (1) on both ends supplied with the unit may be used.

Make connection as follows:

- » Attach cap nut with inner seal ring to inlet screw joint on the humidifier housing and tighten.

NOTICE**Do not overtighten the cap nut!**

Excessive tightening will destroy the fitting.

Please note

Strainer must be placed inside the solenoid valve.

- » Screw the other hose end cap nut with its inner seal on a customer-provided water tap (cap nut internal thread is $\frac{3}{4}$ ").

6.2 Water discharge

▲ WARNING**Risk of scalding!**

During blow down, up to 0.3 l/sec are being drained with a temperature of about 95 °C.

Ensure that the drain hose is reliably fastened and wastewater can drain freely and pressureless.

Please note

Humidifier installation location and wastewater discharge must be on the same pressure level. In case of a drain connection on positive pressure, pls. consult your expert dealer.

Guidelines for water discharge composition

- Use flexible water hose
- Do not buckle drain hose
- Discharge line and drain pipe material must be temperature resistant up to 95°C

How to proceed

- » Run a 1 1/4 " drain hose of 250 to 1000 mm length into a pressure-free outlet according to DIN EN 1717. The hose must be guided sideways of the humidifier to prevent ascending vapor from condensating on the humidifier`s housing.
- » Fit drain hose to connection stub on humidifier housing bottom side.
- » Slide pump drain hose onto one of the grounding clips (s. fig. below).
- » Slide overflow hose of the HyFlow system separator (if present) onto the other grounding clip.

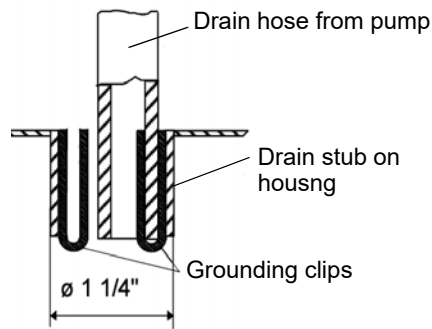

Grounding clip functioning

The two grounding clips attached to the inner surface of the housing drain stub are in direct contact with water and shunt potential residual electric currents away from the housing during blow-down and in case of a cylinder water overflow.

Between the pump drain hose jacket and the inner surface of the cabinet drain connection, a gap exists due to the diverging diameters. If water collects on the base plate, it will flow through this gap into the drain hose and then into the drainage system.

Please note

With the optional wastewater cooling system **HyCool**, HygroMatik offers an option for limiting the steam humidifier wastewater temperature in order to protect thermosensitive wastewater pipe lines. By blending with tap water during blow-down, wastewater temperature is below 60 °C as long as inlet water temperature does not exceed 30 °C.

6.3 Water connections final check

Go down the following water installation checklist:

- All screws and clamps properly tightened?
- Water supply line flushed before making connections?
- Water connection properly installed?
- Water discharge properly installed?
- Does blow-down water drain freely?
- Water supply line and water discharge leakage-free?

7. Electrical connection

⚠ WARNING

Danger of electrical shock!

Dangerous electrical voltage!

All work relating to the electrical installation may only be carried out by designated specialist personnel (electrician or qualified person with equivalent training).

Please note

The customer is responsible for monitoring the qualifications of the specialist personnel..

Do not connect the steam humidifier to the live power supply before all installation work has been completed.

General installation rules

- All local rules concerning the implementation of electrical installations must be obeyed
- Electric connector cables to be laid professionally
- Install the electrical connections according to the wiring diagram
- With units of a nominal power output > 33 kW electrical connection to a permanent line is mandatory (according to VDE 0700 Part 98)

NOTICE

Possible electronical components destruction through electrostatical discharge!

Prior to commencing electrical installation work, steps must be taken to guard the sensitive electronical components of the unit control against damage from electrostatical discharge.

7.1 Electrical installation approach

- » Provide fuses with a contact gap of at least 3mm per pole.
- » Install a separate main connection for each steam cylinder including main circuit breaker, main switch etc. .
- » Make main connection according to the table below.

Main connection

For the StandardLine steam humidifiers, main connection is to be implemented as follows:

Model	Main connection
SLH03	220 - 240 VAC 1/N, 50 - 60 Hz
SLH06 SLH09 SLH15 SLH25 SLH40 SLH50	380 - 415 VAC 3, 50 - 60 Hz

Other operating voltages on request.

Fusing

Please note

HygroMatik recommends the use of slow blowing up to middle time-lag main fuses (applies only when the a.m. mains supply voltage is in use).

Steam humidifier installations should incorporate an individual residual current circuit breaker.

Maximum current draw of the StandardLine standard models and the required fusing resulting from that can be taken from the table below.

Model	Current draw [A]	Fusing [A]
SLH03	9.4 - 10.2	1 x 16
SLH06	10.7 - 11.7	3 x 16
SLH09	16 - 17.5	3 x 20
SLH15	15.7 - 17.1	3 x 20
SLH25	25.9 - 28.3	3 x 32
SLH40	41.6 - 45.4	3 x 50
SLH50	51.9 - 56.7	3 x 63

7.2 Cable connections

The table below shows the number and dimensioning of the cable connections provided by the various StandardLine housing types.

Housing type	M25	M25 with MSI*)	M32	M40
SLH03/06/ SLH09	1x	1x		
SLH15/25	1x		1x	
SLH40/50	1x			1x

Characteristics of metric cable connections

Thread	Wrench size [mm]	Cable diameter supported [mm]
M25x1.5	30	9 - 17
M25x1.5 with MSI*)	30	6 (3x)
M32x1.5	36	13 - 21
M40x1.5	46	16 - 28

*) Multiple seal insert

7.3 Safety interlock

⚠ WARNING

Risk of electrical shock!

Hazardous electrical voltage.
When standard wiring was made, terminal 1 shows 230 VAC after commissioning.

Across terminal 1 and 2 the so-called safety interlock is wired. This wiring allows for integration of safety devices. In case of an open safety interlock the steam humidifier does not operate.

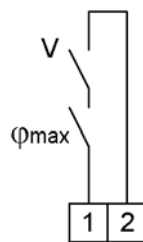

**Safety interlock terminals
1/2 on main PCB**

Please note

Factory setting leaves the safety interlock open!

Install contact interlocks, e.g. a max. hygrostat, vane relays, pressure controllers, air interlock devices etc. in series across terminal 1 and 2.

NOTICE

Contacts across terminals 1 and 2 must be potential free and properly rated!

Rating must comply with the control voltage in use.

Best practice implies the integration of a max. hygrostat in the safety interlock wiring to protect against over-humidification due to a r.h. sensor malfunction.

7.4 Control signal

As described in the „Unit Control“ chapter, section „Provider level submenue and its parameters“, the unit control type is determined by parameter „1-2“, „control signal“. In accordance with the control type selected, terminal wiring of the connection terminal (s. „Unit control“ chapter, section „Main PCB connections“ is to be made.

7.4.1 1-step operation

Steam humidifier operation is controlled by the contact across terminals 3 and 5 provided by the customer. This contact needs only to be low voltage proof.

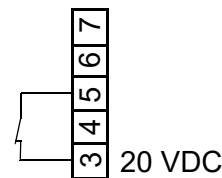

**Customer-provided contact
for 1-step operation**

7.4.2 Operation with an active humidity sensor or external controller

When driving the steam humidifier by an active r.h. sensor or external controller (e.g. a PLC), control signals in the range of 0...10 V, 0...20 mA or 0...140 Ohm may be applied. Each one of the signal types is connected to a dedicated terminal (see „Unit control“ chapter, section „Main PCB connections“). Reference is always to terminal 4, GND.

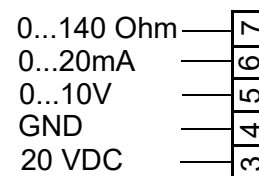

**Terminals for
control signals**

Please note

Active r.h. sensors need an external supply voltage. For that purpose, terminal 3 has a +20 VDC offering.

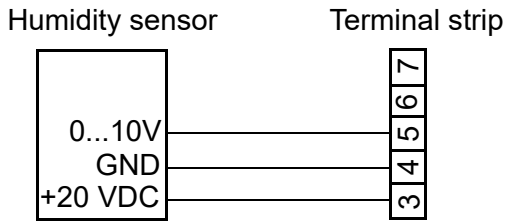

Exemplary 0...10V humidity sensor connection

7.4.3 Wiring for control signal and safety (interlock) system for multiple devices

In the case of multiple units, separate humidifiers work together. The control signal and the safety (interlock) system are connected to the master unit as described above. In addition, connecting cables are established between the guiding unit and the succeeding unit(s) (provided on-site). These provide the succeeding unit with a control signal from the guiding unit and the transmitted (potential free) safety (interlock) system.

The wiring for the control signal and the safety (interlock) system must be implemented as follows for multiple units:

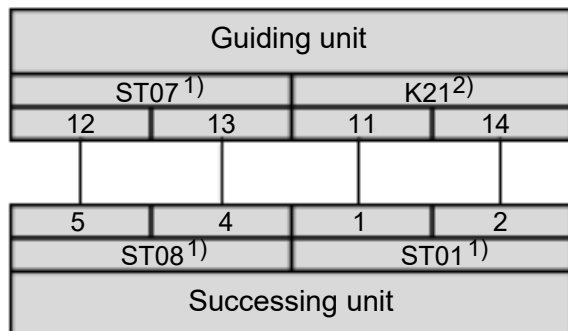

¹⁾ „ST0x“ designates connector plugs on the mainboard

²⁾ „K21“ is the relay used for the connection of the succeeding unit

7.5 Connection diagram

Pls. find the full wiring diagram in the „Unit control“ chapter of this manual (section „Main PCB connections“).

7.6 Electrical installation check list

Check electrical installation with respect to customer-site requirements and local power supply regulations.

- Safety interlock properly wired across terminals 1 and 2?
- Supply voltage in accordance with name plate voltage rating?
- All electrical connections made according to the wiring diagram?
- R.h. sensor properly connected with respect to signal type and supply voltage (only when r.h. sensor is in use)?
- All screw terminal connections properly tightened?
- Have all electrical cable and plug connections been properly tightened?
- Proper unit grounding made?

8. Commissioning

▲WARNING

Risk of operating error!

Start-up of the unit is restricted to expert staff only (electricians or expert personnel with equivalent training).

Step 1: Check of mechanical integrity and wiring

- » Open housing cover.
- » Check cylinder seating.
- » Check steam, condensate and drainhose clamps.
- » Check that all electrical wire connections (including steam cylinder wiring) are tight and secure.

Step 2: Switching on the steam humidifier

- » Switch on main breaker.
- » Open water supply stopcock (operating pressure should be 1bar min., 10bar max.).
- » Switch on unit by setting control switch to "I".

Step 3: The unit performs a self-test and, then, commences normal operation

- During self-test, the On/Off button icon  flashes for a couple of seconds
- On completion of the test, the software version is displayed for a short moment. Consequently, normal operation is commenced. However, steam is not produced without a demand pending

Step 4: Trigger steam demand

- » Set control to 1-step operation, i.e. permanent steam demand, and close safety interlock.

Please note

Steam production may show a delay of up to 20 mins.

- » Allow all electrical functions to terminate in their programmed order.

Step 5: Monitor unit function and check for leakage

- » Let unit operate for 15 to 30 minutes.
- » If leaks appear, switch off the unit.

▲WARNING

Risk of electrical shock!

Hazardous electrical voltage!
Follow safety instructions for work on live components.

Step 6: Repair leaks

- » Find leaks and eliminate.
- » Check again for leaks.
- » When everything is o.k., reattach housing cover.

Additional checks:

- All electrical functions must be executable

9. Maintenance

9.1 General

For the achievement of a long unit life span, regular maintenance is a must. Maintenance works to be performed refer to unit assemblies that underlie either mechanical or electrical wear and tear, or may be impeded by residues in their proper functioning.

The steam humidifier's performance and maintenance intervals primarily depend on the water quality encountered and the amount of steam produced. A particular water quality may shorten or lengthen maintenance intervals. The amount of residues found in the steam cylinder allows for a hint on future maintenance intervals.

Another scenario influencing the unrestricted unit availability refers to the main contactor that has a maximum number of switch cycles as indicated by its manufacturer. Unit control monitors the number of switch cycles and produces a maintenance message as soon as the max. number is reached.

Need for maintenance is indicated by illumination of the  service icon in the unit control panel display. Depending on the trigger, reading value „Status“ then shows a „271“ (Service Steam Amount) when a certain produced steam amount threshold preset was exceeded, or „272“ (Service Main Contactor).

Maintenance work mainly encompasses checking and cleaning all of the unit parts including the steam cylinder inside and the level control device, and a unit test run. As part of the maintenance work, screw terminals and plug connections must be checked each and every time and retightened, if required. Also, the tight fit of all of the plug connections must be ensured.

Since steam and condensate hoses are subject to wear as well, hoses must also be checked regularly.

Seals are wear parts. As such, seal integrity checks and replacement, if required, is also a part of the regular maintenance work.

9.1.1 Safety instructions for maintenance

▲ WARNING

Risk of electrical shock!

Hazardous electrical voltage. Unit must be switched off and protected against restart by expert staff (electricians or expert personnel with equivalent training) before any maintenance work is commenced.

▲ WARNING

Risk of skin burning!

Hot steam cylinder during operation and for some time afterwards.

Drain steam cylinder before any maintenance work is commenced. After that, wait approx. 10 mins before starting maintenance work.

Check steam cylinder temperature by cautious approximation with hand (do not touch!).

▲ WARNING

Risk of scalding!

Water pumped or drained from the steam cylinder may have a temperature of up to 95 °C.

Wear proper PPE (Personal Protection Equipment)!

NOTICE

Take care of ESD protection!

The electronic components of the humidifier control are very sensitive to electrostatic discharges. In order to protect these components during maintenance, steps must be taken to guard against damage from electrostatic discharge.

9.2 Maintenance frame work when unit is operated with fully demineralised water and condensate

Instructions on maintenance and cleaning intervals are entirely based on empirical data.

Cycle time	Maintenance work
4 weeks after initial commissioning	Visual inspection of electrical and mechanical connections. Visual inspection of level control. Visual inspection of the steam cylinder interior.
anually	Visual inspection of electrical and mechanical connections. Visual inspection of level control. Visual inspection of heater element and thermo switch Visual inspection of steam cylinder interior. If required, cleaning of steam cylinder, heater element, thermo switch and level control followed by the replacement of all sealing.

9.3 Maintenance when unit is operated with tap water or partially softened water

No precise maintenance intervals can be specified because these always depend on water quality and the amount of steam generated. It is advisable to adjust the frequency of maintenance to the specific operational experience. HygroMatik recommends to check the opened steam cylinder 1 or 2 weeks after initial commissioning in order to quantify the amount of residue produced so far, allowing for determining future maintenance intervals and/or the adjustment of blow-down cycles possibly required.

Blow-down cycles

The vaporisation process causes hardness builders (calcium) in form of solids of various compositions to fall out within the steam cylinder. Cyclic blow-down by means of a powerful blow-down pump followed by fresh water refills remove parts of this solid built-up.

SuperFlush

Blow-down efficiency may be increased by use of the SuperFlush retrofit kit that boosts the blow-down effect in that it creates a vortex flow in the strainer basket.

Water quality

When tap water is used, it must be taken into account that cleaning intervals shorten as the carbonate hardness level increases. As a general rule, it is preferable to operate the unit with fully demineralized water since operation will not be affected by mineral deposits and flushing loss will be minimized.

Please note

Possibly, maintenance intervals may be extended by moderately increasing the blow-down cycle rate. Please consult your expert dealer.

9.4 Removing and cleaning the steam cylinder

CAUTION

Risk of eye injuries!

The clips that fix the steam cylinder halves have sharp edges and can jump off during dismantling.

Eye injuries possible.

Wear proper PPE (Personal Protection Equipment)!

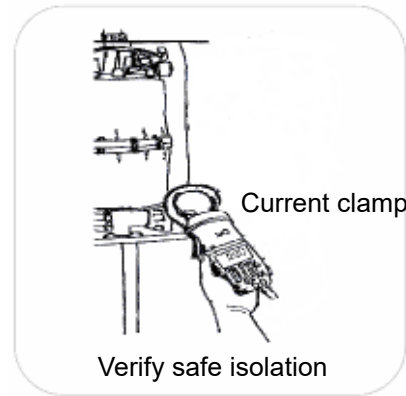

Steam cylinder removal

Set control switch to „II“ position for residual water draining



When cylinder is empty, set control switch to „0“ position

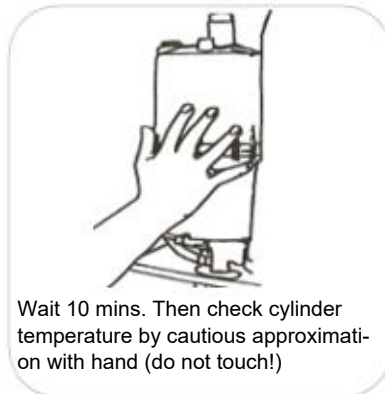
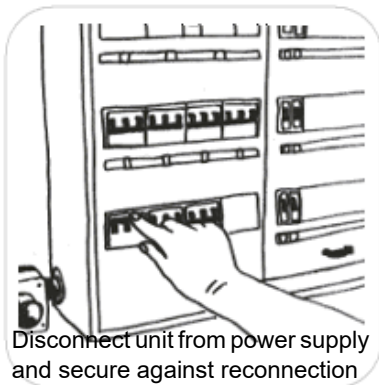
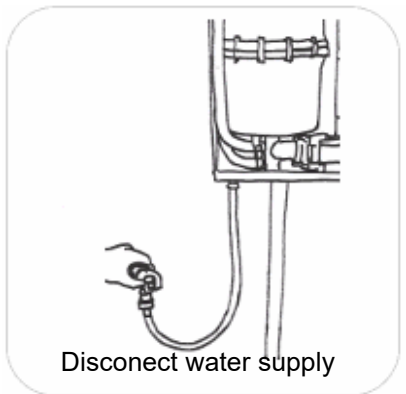

» Remove unit housing cover

- » Remove water sensor hose from cylinder top.
- » Remove SuperFlush solenoid hose from cylinder bottom (if applicable).
- » Remove steam hose from steam hose adapter.

If the steam hose is not to be disconnected, the steam hose adapter with the steam hose still attached may be detached from the steamcylinder as shown in the next figure.

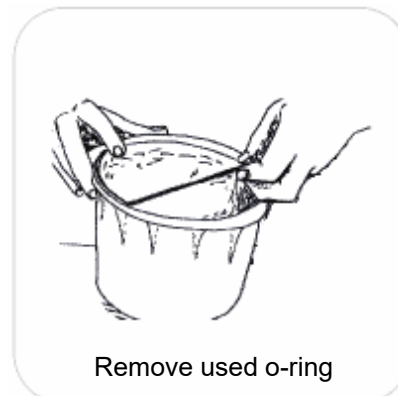
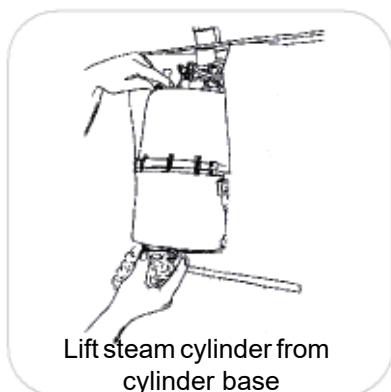
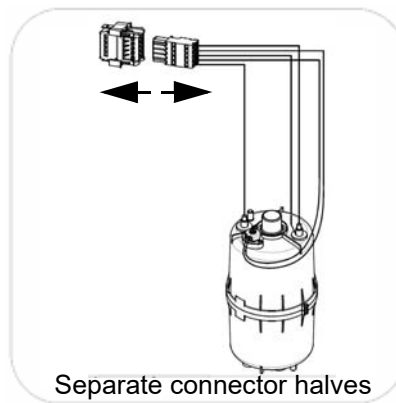
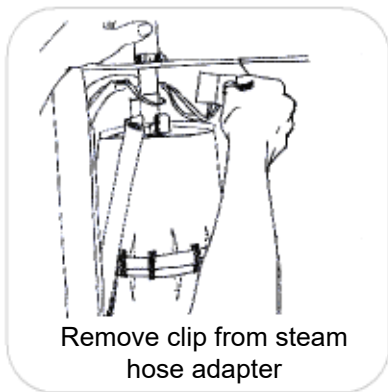

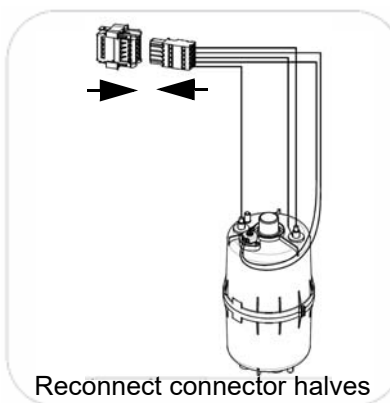
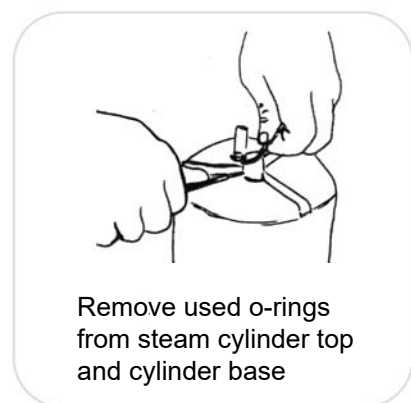
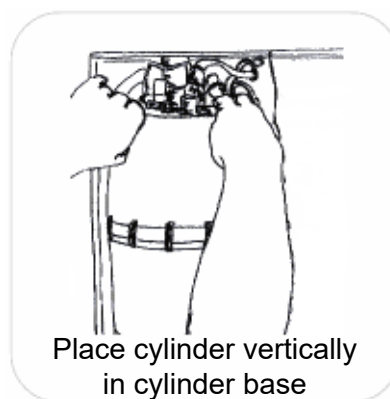
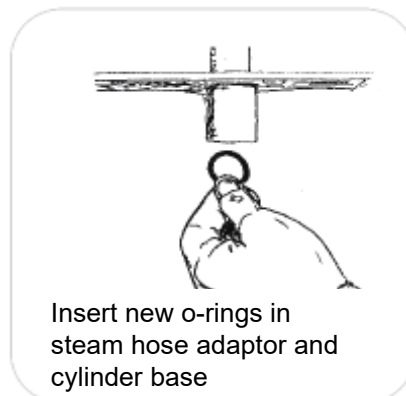
Reinstallation

- » Reattach level control hose to cylinder cover.
- » Reattach SuperFlush solenoid hose (if applicable) to steam cylinder bottom stub.

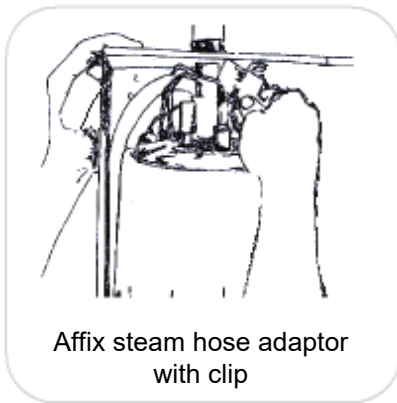
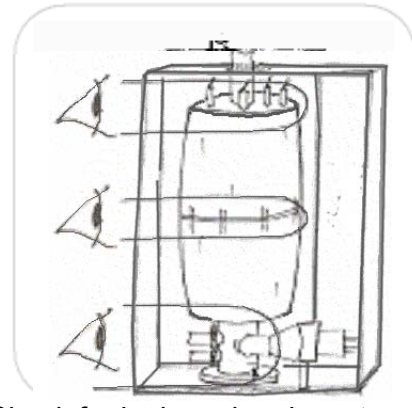

» Reattach unit housing cover

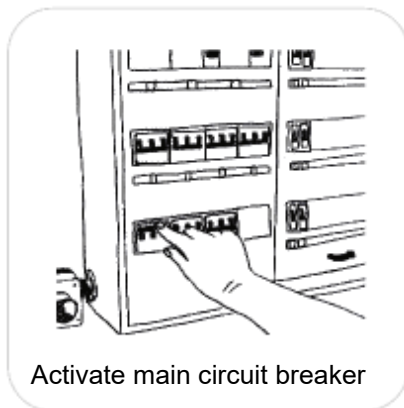
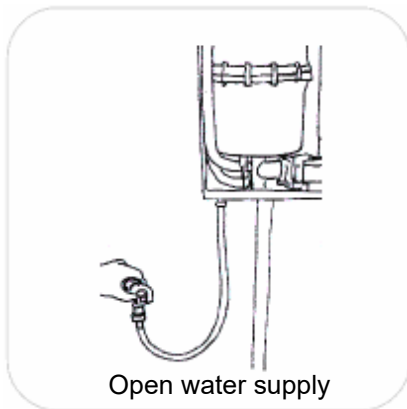

9.5 Steam cylinder and cylinder base cleaning

Removal of the steam cylinder is described in the „Removal and reinstallation of the steam cylinder“ section.

NOTICE

Risk of material damage!

Excessive force when cleaning the cylinder or the heater element(s) may harm these device parts.

NOTICE

Risk of functional disruption!

Use descaler or cleaning detergents only for cylinder and heater element cleaning. Do not introduce in cylinder base or apply to hoses!

Prior to restarting the unit, make sure that the device assemblies in question are thoroughly flushed or rinsed.

- » Remove all deposits. Small amounts of scale deposits on the heater element(s), however, are harmless.

Steam cylinder cleaning

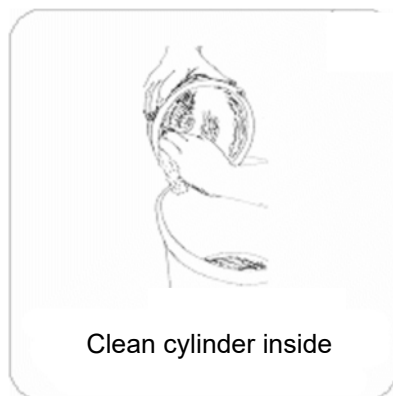

Cylinder base cleaning

Just as the cylinder, the cylinder base and its connection joints must be checked for deposits and cleaned, if required.

9.6 Level control device cleaning

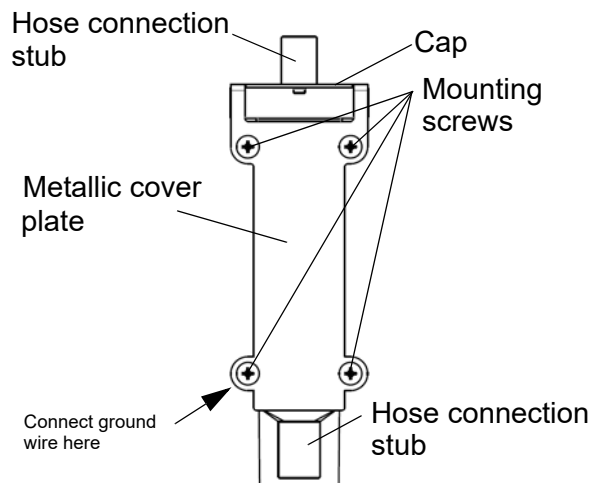

Water sensor

The level control device is accessible only after removal of the steam cylinder.

- » Disconnect hoses from level control device connection stubs on upper and lower side
- » Remove the 4 screws securing the metallic cover plate of the level control device and the device as such against the unit rear wall. Memorize ground wire attachment position (under lower left hand side screw).
- » Unclip level control device enclosure cap with a flick of the thumb and remove.
- » Take out o-ring and dispose of.
- » Make visual inspection of level control device enclosure interior and clean, if required. Scratch out any deposits, if present.
- » Inspect both level control connection hoses and clean, if required.
- » Insert new o-ring.
- » Re-attach enclosure cap.
- » Align metallic plate with level control device enclosure mounting holes and insert screws in upper left and lower right position. Reintroduce level control device into humidifier housing and loosely affix to unit rear wall with the 2 screws.
- » Insert the 2 screws remaining into

the open level control device enclosure mounting holes while positioning the ground wire connection eyelet under the lower left screw.

- » Handtighten all of the screws.

Please note

A functional check of the level control device may only be accomplished while the device is installed into the unit!

9.7 Heater element replacement

Removal

- » Remove and open steam cylinder as described in the „Removing and cleaning the steam cylinder“ section.
- » Disconnect heater wiring connector on partition wall separating electronic compartment.
- » Separate thermo switch capillary tube from heater element(s) by detaching the retainer clips.
- » Remove wiring of the heater element(s) in question from connector terminals (mark positions for reclamping).
- » Unscrew heater element fixing nut(s) from cylinder cover.
- » Remove adjusting washer and grounding lug/lock washer (if present) and pull heater element/s downward out of steam cylinder cover.
- » Clean the sealing surface on the underside of the cover around the area where the new heater element will be installed.

Reinstallation

- » Install replacement heater element(s) (with sealing) while considering the correct sequence of all of the mounting parts. Ensure proper grounding and tighten nut(s).
- » Insert heater element wires into the terminals of the wiring connector following the markings made when disassembling. Polarity is not an issue.
- » Refit thermo switch capillary tube to heater element(s) using retainer clips.
- » Reassemble steam cylinder and reinstall in humidifier housing as described in the „Removing and cleaning the steam cylinder“ section.

9.8 Thermo switch replacement (for heater elements)

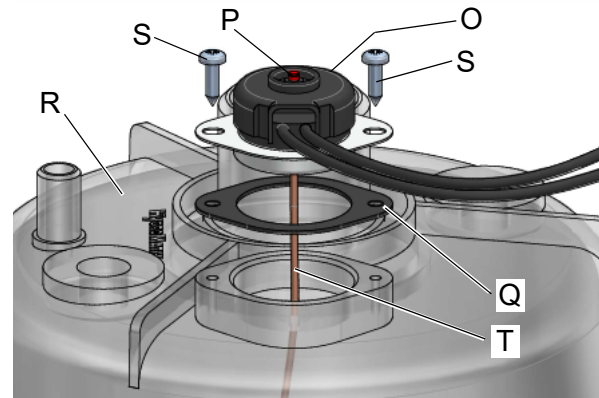

- O: Thermo switch
- P: Thermo sensor release button
- Q: Seal
- R: Steam cylinder
- S: Screw
- T: Capillary tube

Removal

- » Remove and open the steam cylinder as described above in “Removing and cleaning the steam cylinder” section.
- » Detach capillary tube (T) retainer clips from heater element(s).
- » Separate capillary tube from heater element(s) (4).
- » Unscrew the two screws holding thermo switch (S) in place.
- » Pull out thermo switch (O) upwards off steam cylinder cover (R).

NOTICE

Risk of material damage!

Do not buckle thermo switch capillary tube!

Reinstallation

- » Install replacement thermo switch with a new sealing.
- » Properly connect the capillary tube to the heater element. In case of humidifiers with two or more heating elements, the capillary tube is attached to two heating elements.
- » Reassemble steam cylinder and reinstall in humidifier housing as described in the „Removing and cleaning the steam cylinder“ section.

9.9 Releasing a thermo switch that has triggered

To protect the steam humidifier against thermal overload, the unit is equipped with one or two thermo switches, depending on the unit capacity. Mounting positions for the thermo switches are on the cylinder cover. One of the thermo switches (or „the“ one, in case of only one thermo switch present) features a capillary tube for thermal coupling to the heater element. Additionally, the solid state relay is protected with a bi-metal switch attached to the heat sink to prevent damages caused by inadequate ventilation through e.g. covered vents.

From an electrical point of view, all of the thermo switches are connected in series. In case of one of the thermo switches triggering due to a temperature too high, the main contactor K1 drops, while the electronic control enters fault state „120“, i. e. „thermo switch fault“.

In case of one of the thermo switches triggering repeatedly, the reason for this must be identified prior to further unit usage.

Thermo switch(es) on steam cylinder cover.

After the unit has cooled down, the thermo switch that has triggered may be identified by passage measurement, as long as it is a thermo switch on a steam cylinder. Unblocking the thermo switch is accomplished as follows:

Slightly push down the red button (s. above section) protruding a few millimeters from its holder. This will make the button return to its original position and unblock the mechanism.

Relasing a thermo switch does not erase the fault message in the control fault memory.

Thermo switch on solid state relay

The thermo switch attached to the solid state relay is a bi-metal switch without an unblocking feature. Instead, after cool-down, the switch will be unblocked automatically. Restarting the steam humidifier is only possible after cool-down.

9.10 Inspection of wiring connections and heater element wiring

NOTICE

Risk of functional disruption!

Risk of material damage!

Loose cable connections may result in increased transition resistance and contact area overheating.

- » Check all cabling terminals and plugs for tight seating. Plugs must sit on their respective contacts as far as they will go.
- » Check heater element wiring for damaged insulation

9.11 Removal and reinstallation of the solenoid valve including fine filter cleaning

Removal

- » Shut off water supply and disconnect tap water hose cap screw connection.
- » Remove connecting hose (20) from solenoid valve.
- » Detach electrical cable connector from solenoid valve (25).
- » Unscrew solenoid valve mounting screws.
- » Remove solenoid valve from housing bore.

Fine filter cleaning

- » Remove fine filter from solenoid valve tap water connection side and clean under running water.

Reinstallation

- » Reinsert fine filter into solenoid valve.
- » Reinsert solenoid valve with seal in unit housing bore.
- » Bolt-down solenoid valve.
- » Reestablish tap water connection.
- » Reconnect electrical cable to solenoid valve.
- » Reattach connecting hose (20) to solenoid valve using clamp.
- » Turn on water tap.
- » Switch on unit and check for leakages after 15 to 30 mins of operation.

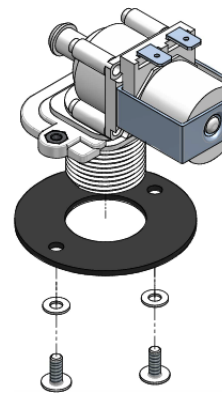

Solenoid valve

▲ WARNING

Risk of electrical shock!

Hazardous electrical voltage!

Follow safety instructions for work on live components.

Leakages may invoke leak currents.

- » In case of leakage turn off power supply and secure against being switched on again.
- » Find leakage and eliminate.
- » Check again.

9.12 Cleaning of blow-down pump

Removal and cleaning

- » Remove steam cylinder as described in „Removal and reinstallation of steam cylinder“ section.
- » Detach adapter (30) from pump (32).
- » Detach electrical cable from pump.
- » Unscrew mounting screws from housing bottom plate (safe vibration buffer, bolts and washers for reinstallation) and pull pump out of cylinder base (37).
- » Open pump bayonet lock.
- » Remove residues from pump and drain hoses (replace O-ring if required).

- » in case of leakage turn off power supply and secure against being switched on again.
- » Find leakage and eliminate.
- » Check again.

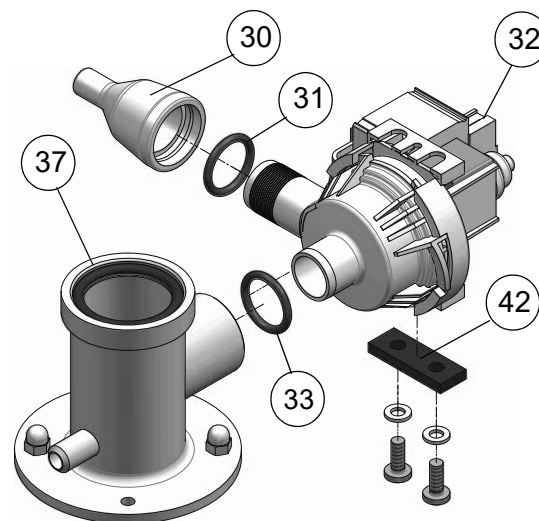

Blow-down pump

Reinstallation

- » Moisten O-ring (33) and insert into cylinder base (37) horizontal stub.
- » Push pump back into cylinder base and bolt to bottom plate incorporating the vibration buffer and washers saved during removal.
- » Moisten O-ring (31) and insert into adapter.
- » Slide adapter (30) onto pump stub.
- » Refit electrical cable to pump connector (no polarisation).
- » Let unit run for 15 to 30 mins, then check for leakages.

⚠ WARNING

Risk of electrical shock!

Hazardous electrical voltage!
Follow safety instructions for work on live components.
Leakages may invoke leak currents.

9.13 Inspection of hoses

Since steam and condensate hoses are prone to wear as well, those hoses should undergo regular checks as well.

9.14 Functional check

- » Run the system with maximum output for a couple of minutes
- » Check all safety devices.
- » Check hose connections and seals for leakage.

10. Dismantling

Once the steam humidifier will no longer be used, dismantle (demolish or scrap) it by following the installation procedures in reverse order.

▲ WARNING

Warning: Dismantling of the unit may only be performed by qualified personnel. Electrical dismantling may only be performed by trained electricians.

Please note

Obey the safety guidelines in section “Safety Instructions,” especially the guidelines for disposal.

11. Unit Control

11.1 General description

Operation of the HygroMatik steam humidifier is under microprocessor control.

A control switch can be found on the device front panel featuring two positions besides the „Zero“-position for a switched-off device.

„Pos. I“ : The unit is switched on

„Pos. „II“ : Cylinder water is manually drained



Control switch

For controlling the unit a control panel featuring a 3-digit display and a number of icons plus 4 touch keys is integrated in the unit front panel. Controlling the unit by software using the modbus RTU protocol is also possible. On request, modbus documentation is available from your expert dealer.



Control panel

For control signal processing inputs are available whose properties may be defined by parameter settings. Activating of the intake solenoid valve, the blow-down pump and the main contactor is achieved through relays on

the main PCB. Another relay serves for signalling purposes (factory setting is „collective fault“).

As an ordering option, for provision of 2 additional switching functions, a pair of top-head rail relays is available for the plugable connection to the mainboard.

Mainboard

The complete control logic including the relays for basic operation is realised on a compact PCB that is mounted on the vertical separating wall between the unit chambers. All connections on the PCB are distinctive in order to allow for easy exchange of the board in case of maintenance.

On the main PCB, two vertically mounted fuse holders with bayonet fitting incorporate 1.6 A fast-blow fine wire fuses (F1 and F2 for L and N, s. section „Basis PCB connections“ in this chapter).

Safety systems

Besides the common external safety interlock (implemented by means of a switching contact or a through a building control system), the following safety is incorporated in the unit:

The electric heater steam humidifier is thermally controlled at two spots minimum. Besides the thermo switch located on top of the steam cylinder and meant for overheating avoidance of the electrical heater element, the solid state relay also is equipped with a thermo switch (higher output units feature 2 thermo switches in the cylinder cover). In case of one of the thermo switches being triggered, the main contactor is deenergised. The thermo switches on the steam cylinders may be reset mechanically after cool-down. The thermo switch attached to the solid state relay heatsink, however, is a bi-metal device. As such, it is released automatically after cool-down.

An other safety measure is the steam cylinder minimum water level control. For heater element protection and thermal overload risk avoidance, no heater element drive enabling is issued in case of minimum water level underrun.

Intrinsic safety

StandardLine steam humidifiers comply with intrinsic safety requirements in that the electrical power supply may be cut by two devices. In case of the electric heater steam humidifier, these devices are the main contactor and the solid state relay.

Please note

For electrical connection of the steam humidifier a residual current circuit breaker is recommended.

11.1.1 Wiring Diagrams

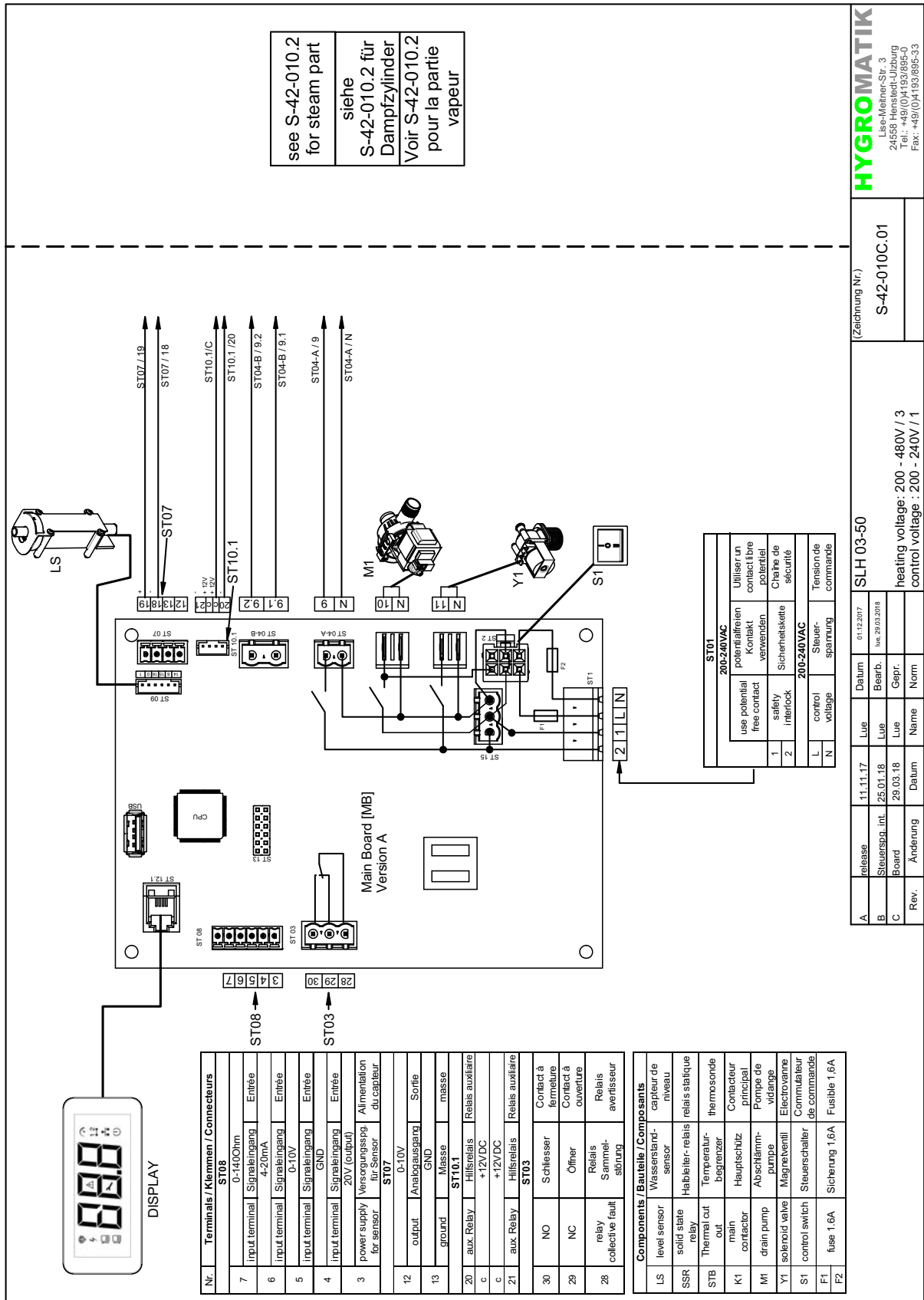

HYGROMATIK
 Liep-Meiener-Str. 3
 24459
 Tel.: +49(0)4193/895-0
 Fax: +49(0)4193/895-53

(Zeichnung Nr.)
S-42-010C.01

Rev.	Änderung	Datum	Name	Norm
A	release	11.11.17	Lue	Datum
B	Steuerung int.	25.01.18	Lue	Bearb. lue, 20.03.2018
C	Board	29.03.18	Lue	Gepr.

SLH 03-50
 heating voltage: 200 - 480V / 3
 control voltage: 200 - 240V / 1

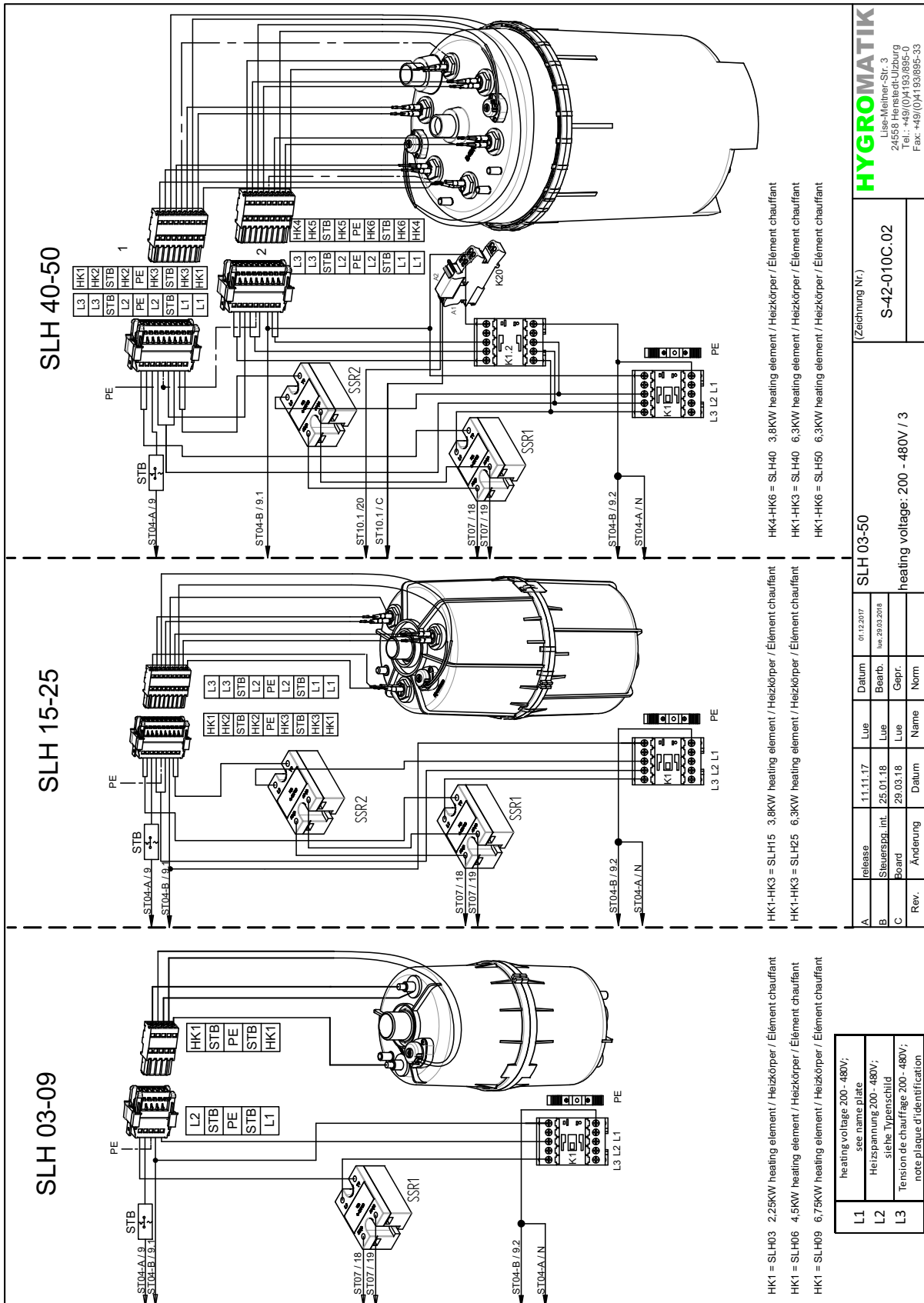

SLH 03-09

HK1 = SLH03 2.25KW heating element / Heizkörper / Élément chauffant
 HK1 = SLH06 4.5KW heating element / Heizkörper / Élément chauffant
 HK1 = SLH09 6.75KW heating element / Heizkörper / Élément chauffant

L1	heating voltage 200 - 480V; see name plate
L2	Heizspannung 200 - 480V; siehe Typenschild
L3	Tension de chauffage 200 - 480V; note plaque d'identification

SLH 15-25

HK1-HK3 = SLH15 3.9KW heating element / Heizkörper / Élément chauffant
 HK1-HK3 = SLH25 6.3KW heating element / Heizkörper / Élément chauffant

A	release	11.11.17	Lue	01.12.2017
B	Steuerungsgl. int.	25.01.18	Lue	16.03.2018
C	Board	29.03.18	Lue	
Rev.	Änderung	Datum	Name	Norm

SLH 40-50

HK4-HK6 = SLH40 3.9KW heating element / Heizkörper / Élément chauffant
 HK1-HK3 = SLH40 6.3KW heating element / Heizkörper / Élément chauffant
 HK1-HK6 = SLH50 6.3KW heating element / Heizkörper / Élément chauffant

SLH 03-50		(Zeichnung Nr.)
heating voltage: 200 - 480V / 3		S-42-010C-02

HYGROMATIK
 Lisa-Meiner-Str. 3
 24559 Hainsried-Gröden
 Fax: +49 (0)4193 895-93

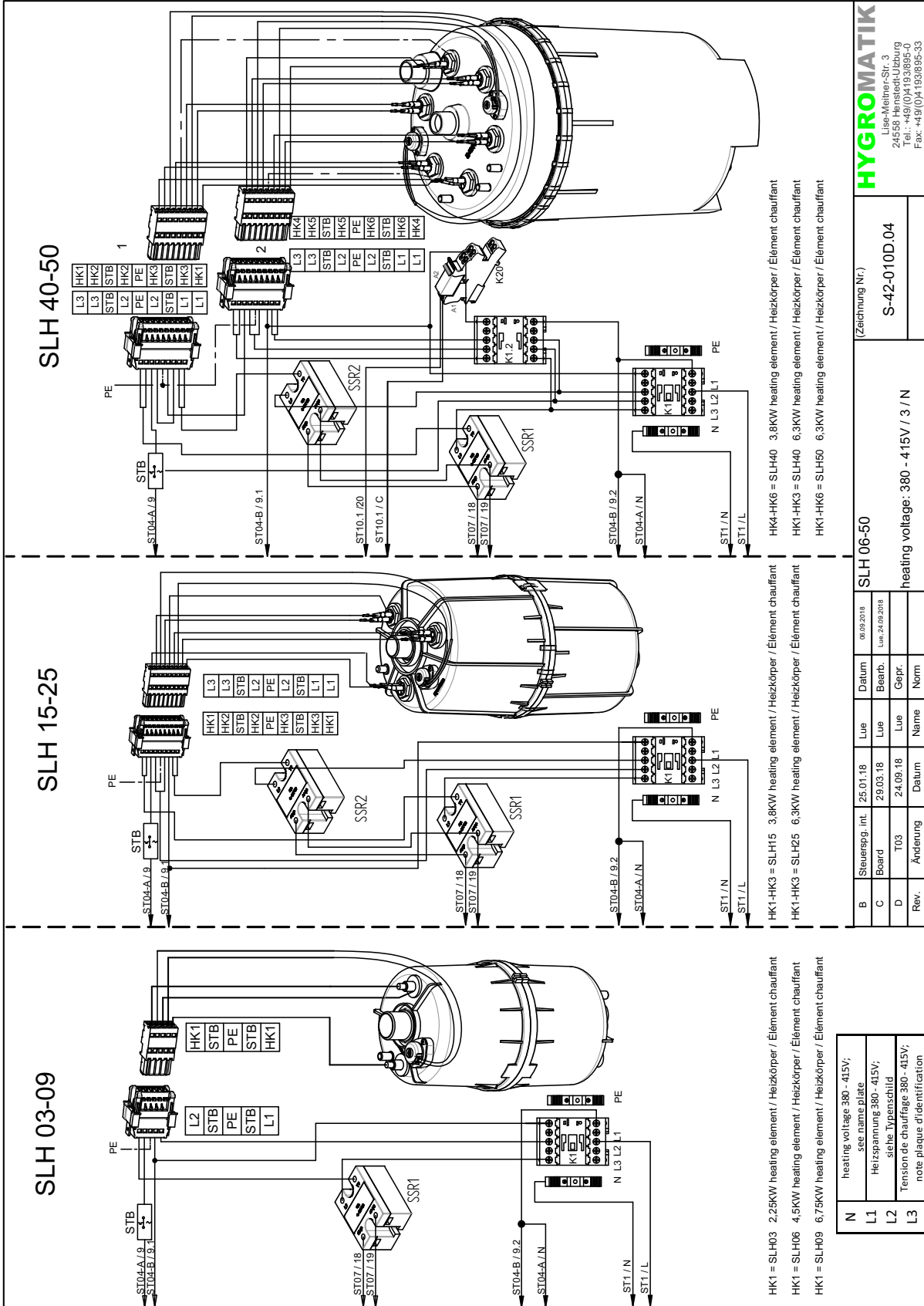

HYGROMATIK
 Lise-Meiner-Str. 3
 24558 Hensstedt-Ubburg
 Tel.: +49(0)4193895-0
 Fax: +49(0)4193895-33

(Zeichnung Nr.)
S-4210D.04

SLH 06-50
 heating voltage: 380 - 415V / 3 / N

B	Steuerspg. int.	25.01.18	Lue	Datum	09.09.2018
C	Board	29.03.18 <th>Lue</th> <td>Bearb.</td> <td>Lue, 24.09.2018</td>	Lue	Bearb.	Lue, 24.09.2018
D	T03	24.09.18 <th>Lue</th> <td>Gepr.</td> <td></td>	Lue	Gepr.	
Rev.	Änderung	Datum	Name	Norm	

11.1.2 Mainboard inputs and outputs

11.1.2.1 Customer side interfaces

Inputs

ST08:

- Control signal 0...10 VDC
- Control signal 0...20 mA
- Control signal 0...140 Ohm

Outputs

ST03:

- Potential-free programmable NC and NO contacts, (factory assignment is „collective fault“)

ST10.1:

- Connection option für 2 additional relays of the top head type (K20, K21) (ordering option). With the SLH40 and SLH50 units, connector ST10.1 is used already for the ex-factory relay K20. In this case, an ordering option is available comprising K21 only .

ST07:

Control signal 0...10 VDC (max. 8 mA)

ST08:

- +20 VDC humidity sensor supply voltage (max. 20 mA)

11.1.2.2 System interfaces

Power supply and safety interlock

ST01:

- 4-pin plug connection with screw terminal adaptor for L and N power connection and safety interlock („Terminals 1/2“)

Inputs

ST09:

- Filling level sensor

ST04-B:

- Galvanically isolated thermo switch input (via optical coupler)
- Dielectric strength 600 VAC

Outputs

ST04-A:

- Main contactor(s)

ST05:

- Blow-down pump

ST06:

- Inlet solenoid valve

ST07:

- Solid state relay control signal (PWM), 20 mA max.

Bidirectional

ST12.1:

- Control panel serial interface

ST 13:

- RS485 interface adapter PCB socket

11.2 Control operation

11.2.1 Principal user guidance

On powering up the steam humidifier, the software version is shown in the display for a few seconds. In normal operation the display then shows actual steam output as a standard display. When a key is pressed the first reading in a list of reading and input values is output. The complete list may be visualized by scrolling using the „▲/▼“ keys. Control-wise, the unit is in „user level“ (see next section).

By means of inputting a 3-digit code, access to „Provider level“ is possible (for input code, see table in section „Provider level submenus and relating parameters“). The provider level parameters are functionally grouped in submenus (1) to (6). The code input is reset to its standard („000“), should no keystroke occur within 3 minutes.

11.2.2 Menu structure

Overview on menu structure

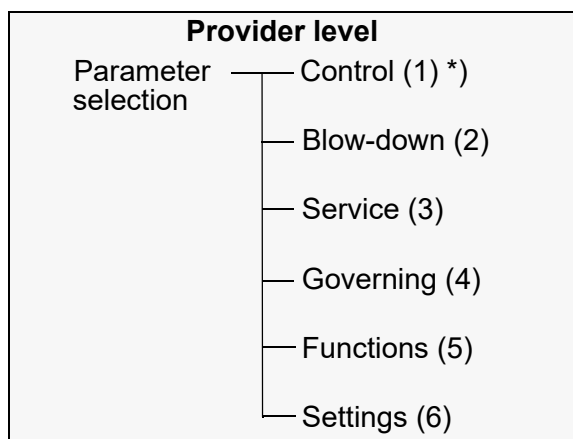
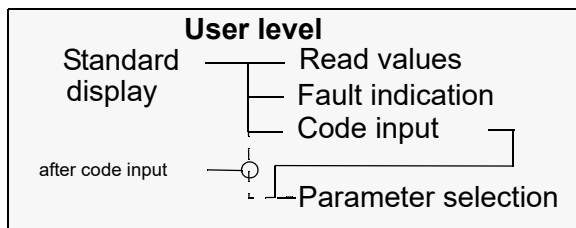

*) numbers in parenthesis are group numbers

User level

From standard display (actual steam output), user level may be accessed by pressing any key on the control panel. On user level, among other information, reading values r01 to r12 are available. After a certain time span with no keystroke, control switches the display back to standard display. Factory setting for this timeout is „10 minutes“.

Besides showing the reading values, user level also features „P00“ for code input allowing provider level access (s. „Menu tree section“).

Provider level

On provider level, the control parameters of functional groups (1) to (6) (s. „Overview on menu structure“) may be individually changed. A tabular list of the provider level parameters and a more detailed description may be found in the sections „Provider level submenus and their parameters“ and „Detailed parameter descriptions“, respectively, further down in this chapter.

Menu tree

The detailed menu tree with all of the reading values and settable values as well as all of the parameters is depicted in the next section.

11.2.3 Menu tree

User level

Provider level⁴⁾

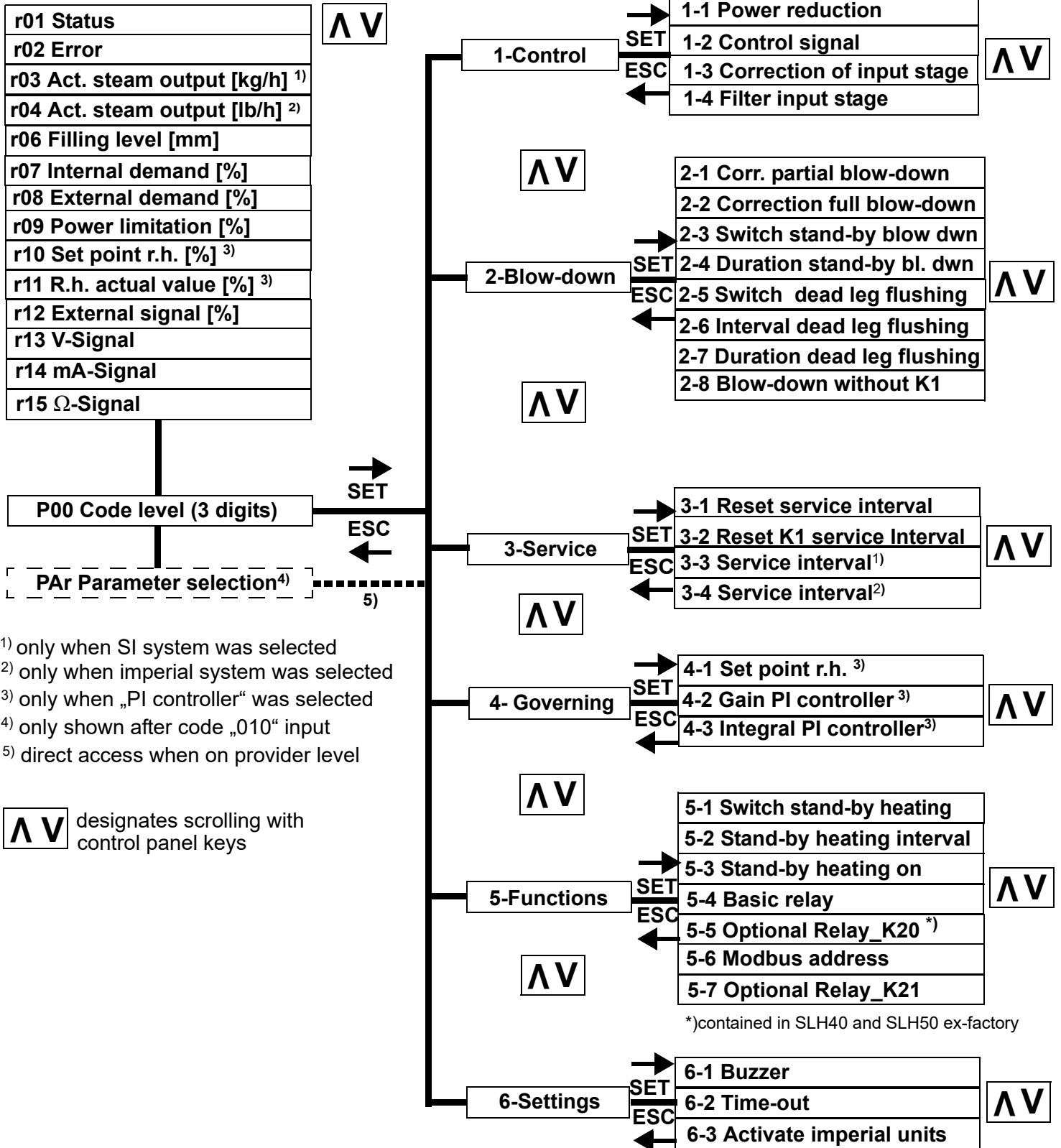

11.3 The control panel



The control panel comprises 3 sections:

- the ESC, SET, **^**, **v** control keys
- the 3-digit 7-segment display
- dedicated icons for operating status indication

Please note

A flashing icon always indicates a faulty situation!

Exception: When switching the unit on, the complete display flashes 4 times. Then, the power-on-LED blinks while the device self test is run.

The **control keys** enable navigation in the menus and submenus. Their function is as follows:

„ESC“: cancellation or return to previous level

„**^**/**v**“: move up/down within a menu, submenu or selection list.

„SET“: accept and store a selected setting.

The 3-digit **7-segment-display** serves for outputting of operational and input data as well as error code presentation. When control software expects an input the digits are blinked. Display semantics are determined by lightening-up of one or more icons related to a specific operational situation or device control environment.

Icons state table

	permanently lit	flashing
	Steam production active	Cylinder full <u>In conjunction with error icon:</u> Fault steam production
	Main contactor active	Fault main contactor
	Filling active	Fault filling
	Blow-down active	Fault blow-down
	(State not possible)	Error s. error codes
	Maintenance required	(State not possible)
	Demand	Fault control signal
	Safety interlock closed	(State not possible)
	Virtual safety interlock closed by software enabling	(State not possible)
	Control active	Control self test after unit start

11.4 Navigation within a menu

User level entry

Standard display during normal operation is actual steam output in the selected dimension ([kg/h] or [lbs/h], respectively). By pressing any key, user level comprising a reading value index (pointer) selection level and the reading values as such is entered.

„r01“ is displayed indexing the first reading value.

Reading value display

By scrolling using the „▲/▼“ keys, the reading value indexes „r01“ to „r12“, code entry „P00“ (s. below) and parameter selection „PAr“*) may be addressed. The actual reading value content is output on pressing the SET key after selection of one of the reading value pointers r01 to r12.

Use the ESC key for return to the reading value index level that allows for addressing further reading values.

„P00“ allows for inputting a code for provider level entry that supports changing of the parameters (s. next section). This function is not meant for usage by the steam humidifier user.

*) „PAr“ ist only presented when a „10“ was input as the „P00“ setting value for access to provider level. When „PAr“ is confirmed with the SET key, parameter group selection is supported without the need for inputting the access code again.

Provider level code entry and setting a parameter

- » Using the „▲/▼“ keys, scroll until „P00“ is displayed and confirm with the SET key. „00“ is displayed.
- » Increase the display to „10“ using the „▲/▼“ keys and confirm with the SET key („10“ is the access code for the provider level). „1- “ is now displayed for selection of one of the parameter groups (1) to (6).
- » Confirm parameter group (1) with the SET key or make an other selection with the „▲/▼“ keys and then confirm. The display will now show a „1“ in the right digit position for addressing the parameter index (e.g., „2-1“).
- » Confirm selection with the SET key or vary selection with the „▲/▼“ keys and then confirm.

Use the ESC key for return to the previous input level.

11.5 Tabular representation of reading value list and provider level submenus

For a detailed description, pls. refer to the respective sections within this chapter.

11.5.1 The reading value list

From normal operation, the user may access the reading value index „r01“ (Status) by pressing any key.

By scrolling using the „**▲/▼**“ keys the reading and setting values indicated in the table below may be addressed. To output the value content, the SET key must be pressed first.

Reading value index	Description
r01	Status
r02	Fault
r03	Actual steam output [kg/h]
r04	Actual steam outpt [lb/h] (only when imperial units were selected)
r06	Filling level [mm]
r07	Internal demand [%]
r08	External demand [%]
r09	Power limitation [%]
r10	Set value r.h. [%] (only when PI controller was selected)
r11	Actual value r.h. [%] (only when PI controller was selected)
r12	External signal [%]
r13	V-Signal
r14	mA-Signal
r15	Ω-Signal
P00	Code level („0“, „10“)
PAr	Parameter group selection

11.5.2 Provider level sub-menus and relating parameters

Detailed parameter descriptions may be found in the section „Detailed parameter description“ further down in this chapter. The „Setting options“ column indicates the presettings available or the range of values to be chosen from. „Fs“ stands for „Factory setting“.

Submenu „Control“ (Group1)

Par.	Denomination	Setting options	Code
1-1	Steam output max. [%]	25 ... 100 Fs*) = 100	10
1-2	Control signal	0= not valid 1= ext. controller, 0 ... 10 V 2= ext. controller, 0 ... 20 mA 3= ext. controller, 0..140 Ω 4= PI controller, 0 ... 10 V 5= PI controller, 4 ... 20 mA 6= PI controller, 0 ... 140 Ω 7= 1-step 8= Modbus Fs = 1	10
1-3	Correction input stages [%]	-5.0 ... +5.0 Fs = 0	10
1-4	Filter input stage	0=light, 1=strong Fs = 0	

*) Fs = Factory setting

Submenu „Blow-down“ (Group 2)

Par.	Denomination	Setting options	Code
2-1	Correction partial blow-down	-5...+5 Fs = 0	10
2-2	Correction full blow-down	-5...+5 Fs = 0	10
2-3	Switch stand-by blow-down	0=off, 1=on Fs = 1	10
2-4	Waiting time stand-by blow-down [h]	0.1...48.0 Fs = 24.0	10
2-5	Switch dead leg flushing	0=off, 1=on Fs = 0	10
2-6	Interval dead leg flushing [h]	0.1...96.0 Fs = 24.0	10
2-7	Duration deadleg flushing [s]	1...600 Fs = 90	10
2-9	Steam-down time	0...250 WV=240	10

Submenu „Service“ (Group 3)

Par.	Denomination	Setting options	Code
3-1	Reset service interval steam amount	0=no, 1=yes Fs = 0	10
3-2	Reset K1 service interval	0=no, 1=yes Fs = 0	10
3-3	Service interval [t]	0...90.0 Fs = device dependant	10
3-4	Service interval [tn. sh.]	0 ...90.0 Fs = device dependant	10

Submenu „Governing“ (Group 4)

Par.	Denomination	Setting options	Code
4-1	Set point r.h. [%] (PI controller only)	5...99.9 Fs = 50.0	10
4-2	Gain [%] (PI controller only)	0.1...99.9 Fs = 5.0	10
4-3	Integral [%] (PI controller only)	0...100.0 Fs = 10	10

Submenu „Functions“ (Group 5)

Par.	Denomination	Setting options	Code
5-1	Switch stand-by heating	0=off, 1=on Fs = 0	10
5-2	Interval stand-by heating [min]	1...999 Fs = device dependant	10
5-3	Stand-by heating [s]	1...999 Fs = device dependant	10
5-4	Basic relay	0 = collective fault 1 = stand-by 2 = no demand 3 = humidifying 5 = remote off 30 = filling off 31 = filling on 37 = HyCool 60 = Blow-down off 61 = Blow-down on 62 = Partial blow-down 63 = Full blow-down 66 = max. level 67 = Stand-by blow-down 68 = Dead leg flushing 69 = Start-up blow-down 270 = Collectice Service Fs = 0	
5-5	Relay_K20	same as for basic relay Fs = 270	10
5-6	Modbus address	0..255 Fs = 1	10
5-7	Relay_K21	same as for basic relay Fs = 270	

*) in the SLH40 and SLH50 units, Relay K20 is programmed with „120“ ex-factory for stage 2 switching. This allocation can not be changed.

Submenu „Settings“ (Group 6)

Par.	Denomination	Setting options	Code
6-1	Buzzer	0=off, 1=on Fs = 0	10
6-2	Time-Out (return to standard display) [min]	0 ... 60 Fs = 2	10
6-3	Activate imperial units	0 = SI units 1 = imperial units Fs = 0	10

11.6 Exemplary variation of a parameter setting

Example: Control signal is to be changed from „Ext. controller, 0 ...10V“ („1-2“ = „1“) to „PI controller, 0 ...10V“ („1-2“ = „4“).

Please note

The steps below make an essential change to a control parameter. If this is not intended, be sure to reestablish the original setting after changing it for exercising purposes.

- » In normal operation, press any key to access the reading value list. „r01“ is displayed.
- » Scroll from „r01“ to „P00“ (Code input).
- » Press SET key. Display now shows a flashing „Zero“ for code level „0“ (user level) and input readiness.
- » Using the „▲/▼“ keys, change the display to „10“.
- » Press the SET key. Provider level is now entered. „1-“ is displayed as the first parameter group to be changed.
- » Since the parameter to be changed is in this group already, group confirmation can be made immediately with the SET key.
- » Scroll with the „▲/▼“ keys to the „1-2“ position and confirm with the SET key. The parameter setting „1“ (external controller, 0...10V) is displayed and may be changed.
- » Change the setting to „4“ (PI controller, 0...10V) with the „▲/▼“ keys and confirm with the SET key.
- » Pressing the ESC key twice brings the display back to standard display (i.e. actual steam output).

These steps are exemplary. In the same way, selection and variation of all of the other parameters may be accomplished.

11.7 Detailed description of the user level reading values and settings

Reading value		Explanation	
r01 Status	Code	Denomination	Description
Main functions category	00	Start	Humidifier is in startup phase after a cold start. The Power-ON-LED flashes.
	01	Stand-by	Safety interlock is open (safety interlock icon in display is not lit). No steam is produced. In case of the safety interlock being opened by software, status „05“ (Remote off) is displayed instead of „01“.
	02	No demand	Demand from external controller or active humidity sensor is below switch-on threshold of the steam humidifier. No steam is produced (while the safety interlock is closed). The demand icon in the display is not lit.
	03	Humidify	Steam is produced when demand is generated by a Hygrostat or an external controller. With a PI controller setting, an input signal from the active humidity sensor is required. (Safety interlock must be closed).
	05	Remote off	Safety interlock was opened via Modbus (e.g. by a building control system instruction).
	06	No Modbus	When 1-2 = „Modbus“ is selected, demand messages are required on a regular base. In case of no demand within a 20 s time frame, „No Modbus“ is shown as the device status and steam production is stopped (for details, see dedicated Modbus documentation available from HygroMatik GmbH).
	07	Stand-by heating interval	When in stand-by heating mode, status code 07 is displayed during steam production.
	08	Stand-by heating pause	When in stand-by heating mode, status code 08 is displayed when no steam is produced.
Filling category	30	Filling	Filling is active via solenoid valve. The filling icon in the display is lit.
Blow-down category	60	Initial blow-down	After switching the device on, a blow-down sequence is run with the parameter set for partial blow-down.
	61	Partial blow-down	A partial blow-down is run in order to achieve cylinder water concentration reduction. The blow-down icon in the display is lit.

Reading value		Explanation	
Blow-down category (contd.)	62	Full blow-down	Full blow-down is run (steam cylinder is completely drained). The blow-down icon in the display is lit.
	65	Max. level	Max. allowable water level in steam cylinder was overrun.
	66	Stand-by blow-down	In case of a safety interlock open for a longer period of time, a full blow-down is run automatically after a time preset in order to avoid stagnant water in the steam cylinder. The blow-down icon in the display is lit.
	67	Dead leg flushing	Special blow-down mode for flushing dead leg tubing. Solenoid valve and blow-down pump are activated simultaneously in case of a no demand situation for a certain period of time. The blow-down icon in the display is lit.
	80	Partial blow-down waiting	Device will start partial blow-down with next filling step.
	81	Full blow-down waiting	Device will start full blow-down with next filling step.
Service category	271	Service steam amount	The service threshold for the steam amount produced as preset in 3-3 (SI units) or 3-4 (imperial units) was exceeded. The service icon in the display is permanently lit for the time the message is active. The status message may be reset by setting parameter 3-1 to „1“.
	272	Service main contactor K1 switching cycles	The number of main contactor switching cycles predefined by the manufacturer was met. A main contactor replacement is advisable. The service icon in the display is permanently lit for the time the message is active. For resetting the status message, parameter 3-2 must be set to „1“.
Fault category	999	Fault	A fault was detected. Operation has ceased. An error code may be read out. Some certain faults also make an icon in the display blink.
r02 Error (only shown when a fault has occurred)		The error code related to the fault is displayed (steam production is stopped whenever a fault occurs). Error codes are described in the „Trouble shooting“ chapter of this manual.	
r03 Actual steam output (SI units)		Amount of current steam production value [kg/h]	
r04 Actual steam output (imperial units)		Amount of current steam production value [lb/h]	
r05 Actual current		Current electrode amperage value [A]	

Reading value	Explanation
r07 Internal control signal	The internal signal for controlling the steam humidifier electrical power delivery is displayed. [%]. This reading is influenced by the control curve and a power limitation preset
r08 External demand (only with ext. controller)	External controller control signal is displayed [%]
r09 Power limitation	Power limitation as a percentage of max. output as preset in parameter „1-1“ is displayed [%]
r10 Set point r.H. (only when PI controller was preset)	R.h. nominal value as preset in parameter 4-1 is displayed [%]
r11 Actual value r.h. (only when PI controller was preset)	Actual value of r.h. is displayed [%].
r12 External signal	External signal [%]
r13 V-Signal	Input signal measured at terminal ST805 [V]
r14 mA-Signal	Input signal measured at terminal ST806 [mA]
r15 Ω-Signal	Input signal measured at terminal ST807 [Ω]

Set value	Explanation
P00 Code level	Allows provider level access by code input
PAr Parameter selection	Allows selection of parameter group and of a specific parameter within a group

11.8 Detailed parameter descriptions

Group	Par.	Denomination	Description
Control	1-1	Steam output limitation	Steam output limitation allows scaling down the max. (steam) output within a range of 25 to 100 %, which may be necessary for a better control performance. The actual steam output is determined by the control signal.
	1-2	Control signal	This parameter tells the unit control software what kind of control signal is wired. Also, the control characteristic is defined. These are the setting options: 1 = external controller, 0...10 V 2 = external controller, 0...20 mA 3 = external controller, 0...140 Ω 4 = PI controller, 0...10 V 5 = PI controller, 4...20 mA 6 = PI controller, 0...140 Ω 7 = 1-step 8 = Modbus
	1-3	Correction of input stages	This parameter allows for an active humidity sensor calibration in the range from -5% r.h. to +5% r.h. .
	1-4	Filter input stage	This parameter allows for switching the damping of the input low pass filter from „light“ to „strong“. With a capacitive humidity sensor, increasing the input damping is meaningful for improving the signal-to-noise ration and for reducing the oscillating tendency.
Blow-down	2-1	Correction partial blow-down	In case of high electrical conductivity of water or excessive maintenance effort, increasing the blow-down frequency may be meaningful. When conductivity is low, however, a lower blow-down frequency may be adequate. To cope with different water qualities, blow-down rates may be adapted within a range of 10 stages (factory presetting is „0“). Increase blow-down rate: settings up to +5. Decrease blow-down rate: settings up to - 5. A blow-down rate too low will lead to significant wear and tear and will also increase the maintenance effort required. Pls. note: a „-5“ setting will shut off blow-down completely!

Group	Par.	Denomina- tion	Description
Blow-down (contd.)	2-2	Correction full blowdown	see correction partial blow-down
	2-3	Switch stand- by blow-down	Should steam humidifier operation be prospectively halted for a longer period of time, blowing-down the cylinder water is advisable in order to comply with the VDI 6022 hygiene regulations prescribing the prevention of microbial contamination of residual water. Parameter 2-3 is the switch to activate and de-activate the stand-by blow-down function. When activated, a full blow-down is run after a waiting time that was determined by setting parameter 2-4 to the value in question. For stand-by blow-down to become effective, the unit control switch must remain in the „On“- position („I“).
	2-4	Waiting time stand-by blow-down	Determines the waiting time until the cylinder water is fully drained to counteract contamination when no steam is produced for a lengthy period of time (factory setting is 24 hours).
	2-5	Switch dead leg flushing	When parameter 2-5 = „1“, for flushing of the supply line, solenoid valve and blow-down pump are simultaneously activated after the time preset in parameter 2-6 and for the duration of time preset in 2-7. In order for this to work, the safety interlock must be closed.
	2-6	Interval dead leg flushing	Waiting time [h] when there is no steam production until dead leg flushing is activated; only valid if switch 2-5 = „1“.
	2-7	Duration dead leg flushing	Duration of dead leg flushing [s].
	2-9	Steam-down time	This parameter serves for monitoring proper unit functioning. When steam production is called-for by the control software, a cylinder filling variation must be detectable within the timespan defined by „2-9“. Should this not be registered, the unit enters error state „123“ (error steam-down time) and cuts steam production.

Group	Par.	Denomination	Description
Service	3-1	Reset steam-service interval	On finishing maintenance work, the service interval is to be reset (the service icon is blanked if it was illuminated before).
	3-2	Reset K1 service interval	Main contactor switching cycles are monitored and compared to the life expectancy figure supplied by the part's manufacturer. On a match, reading value r01 is set to „270“ (and the service icon LED flashes). After changing the main contactor, parameter 3-2 must be set to „1“ for a reset of the status message.
	3-3	Steam service interval	Unit control monitors the actual steam amount produced and compares it with the service steam amount that was determined by the parameter 3-3 setting. When the two data match, the service icon is lit. Steam humidifier operation is not disrupted. Service rate highly depends on water quality (conductivity, hardness) and on the amount of steam produced since the last service. By varying parameter 3-3, the service interval may be adjusted to water quality.
Governing These parameters are only effective when parameter 1-2 (control signal) holds a setting incorporating the PI controller.	4-1	Set point r.h.	Parameter 4-1 determines the r.h. set point for control.
	4-2	Gain PI controller	Sets the PI controller gain (Xp) [%].
	4-3	Integral PI controller	Sets the PI controller resetting time (Xn).

Group	Par.	Denomina- tion	Description
Functions	5-1	Switch stand-by heating	Stand-by heating is enabled or not (0= off, 1=on).
	5-2	Interval stand-by heating	Parameter 5-2 determines the interval time between heating phases when stand-by heating was enabled.
	5-3	On-time Stand-by heating	Parameter 5-3 sets the heating on-time when stand-by heating was enabled.
	5-4	Basic relay allocation	<p>The basic relay features potential-free NC and NO contacts across terminals 28,29 and 29,30, respectively (contact capacity is 250 VAC/8A).</p> <p>The relay is activated when a certain operating status is achieved. Parameter 5-4 allows for allocating a logical function, i.e. the relay is energised when a certain operating status occurs. Factory setting is „0“ defined as „collective fault“</p> <p>The following allocations are supported:</p> <p>(0) Collective fault: Relay is energised in case of any fault.</p> <p>(1) Stand-by: Relay is energised when the unit is in stand-by.</p> <p>(2) No demand: Relay is energised when input signal creates no demand.</p> <p>(3) Humidifying: Relay is energised when humidifying is active.</p> <p>(5) Remote off: Relay is energised when safety interlock was opened under software by means of the building control system.</p> <p>(30) Filling off: Relay is energised when filling is not active.</p> <p>(31) Filling on: Relay is energised when filling.</p>

Group	Par.	Denomina- tion	Description
Functions	5-4	Basic relay allocation (contd.)	<p>(37) HyCool: Relay is energised for switching on HyCool-function solenoid valve.</p> <p>(60) Blow-down off: Relay is energised when not pumping.</p> <p>(61) Blow-down on: Relay is energised when pumping takes place.</p> <p>(62) Partial blow-down: Relay is energised when a partial blow-down is run.</p> <p>(63) Full blow-down: Relay is energised when a full blow-down is run.</p> <p>(66) Max. level: Relay is energised when the max. allowable water level is overrun.</p> <p>(67) Stand-by blow down: Relay is energised when a stand-by blow-down is run.</p> <p>(68) Dead leg blow-down: Relay is energised when a dead leg blow-down is run.</p> <p>(69) Start-up blow-down: relay is energised when a start-up blow-down is run.</p> <p>(270) Collective Service: Relay is energised when a service message status („Service steam amount“, „Service main contactor K1 switching cycles“) is active.</p>
	5-5	Relay_K20 allocation (connected to the ST10.1 connector on the main-board)	<p>Defines logical function of the optional relay K20 (in the same way as 5-4 does for the basic relay). Factory preset is „270“ (Collective service).</p> <p>Exemption: In the SLH40 and SLH50 units Relay_K20 is used ex-factory for switching stage 2 (i.e. the 1-step control of 3 heater elements). Relay allocation is then „120“ ex-factory and can not be changed.</p>
	5-6	Modbus address	<p>The control electronic may optionally be equipped with a RS485 serial interface for running data communication with the Modbus RTU protocol. 5-6 then holds the Modbus RTU address.</p>
	5-7	Relay_K21 allocation (connected to the ST10.1 connector on the main-board)	<p>Defines logical function of the optional relay K21 (in the same way as 5-4 does for the basic relay). Factory preset is „270“ (Collective service).</p>

Group	Par.	Denomination	Description
Settings	6-1	Buzzer	The control panel features a buzzer for prompting key strokes. Parameter 6-1 allows for muting the prompt.
	6-2	Time-Out	Unit control switches the display back to actual steam output presentation after the time set in 6-2. Factory setting is „2 minutes“
	6-3	Imperial units	This parameter enables a switch between SI units and imperial units. Actual steam output e.g. will then be in „lb/h“ instead of „kg/h“.





12. Trouble shooting



12.1 Error handling







On occurrence of a fault, steam production is stopped. The control panel display is switched to error code output. In the same instance, the general fault icon  starts flashing.

On „Steam production“, „Main contactor“, „Filling“ and „Blow-down“ faults, the respective icon is additionally blinked.



12.1.1 Table of possible faults and related error codes

Icons	Code	Error message	Possible cause	Counter measure
	000	No error		
	001	Sensor plug (ST09)	<ul style="list-style-type: none"> • Plug not attached or loose 	<ul style="list-style-type: none"> • Check plug
	020 021 *)	Min./max. reference for voltage control signal not correct Software has detected implausibility	<ul style="list-style-type: none"> • Sensor, input wiring or signal source not correct • Input stage defective 	<ul style="list-style-type: none"> • Check sensor, signal cable and signal source, if applicable • Replace main PCB
	022 023 *)	Min./max. reference for current control signal not correct Software has detected implausibility	<ul style="list-style-type: none"> • Sensor, input wiring or signal source not correct • Input stage defective 	<ul style="list-style-type: none"> • Check sensor, signal cable and signal source, if applicable • Replace main PCB
	024 025 *)	Min./max. reference for resistive control signal not correct Software has detected implausibility	<ul style="list-style-type: none"> • Sensor, input wiring or signal source not correct • Input stage defective 	<ul style="list-style-type: none"> • Check sensor, signal cable and signal source, if applicable • Replace main PCB
*) When a PI controller is in use, errors 020-025 relate to the sensor output signals. With an external controller the controller output signal is concerned.				
	027	System failure	<ul style="list-style-type: none"> • Main PCB is defective 	<ul style="list-style-type: none"> • Replace main PCB

Icons	Code	Error message	Possible cause	Counter measure
 	030	<p>Filling</p> <p>Filling was not successful, i.e. , after 30 mins of filling time the expected level was not achieved.</p>	<ul style="list-style-type: none"> • Solenoid valve or water supply line contaminated or defective • Solenoid valve defective • Water supply not opened • Solenoid valve electrically not driven <ul style="list-style-type: none"> - electrical cabling not o.k. - Main PCB relay not energised • Steam hose not laid with sufficient incline/ decline resulting in a water bag obstructing steam flow. Steam builds up pressure in steam cylinder and pushes water towards drain 	<ul style="list-style-type: none"> • Clean water supply line and/or solenoid valve; replace solenoid valve, if defective • Make measurement on solenoid; replace solenoid valve, if defective • Open water supply -Check electrical cable and replace, if required - Measure voltage on main PCB terminal 11 against N; replace PCB, if required • Check steam hose layout. Eliminate water bag.

Icons	Code	Error message	Possible cause	Counter measure
 	<p>061 062 065 066 067</p>	<p>Blow-down fault, relates to:</p> <p>Partial blow-down Full blow-down Max level blow-down Stand-by blow-down Start_blow-down</p> <p>Indicated blow-down was not successful</p>	<ul style="list-style-type: none"> • Blow-down pump not driven <ul style="list-style-type: none"> - electrical wiring not o.k. - Main PCB relay not energised • Blow-down pump defective • Blow-down pump working but water is not drained (i.e. cylinder drain is blocked) • Blow-down pump blocked by hardeners 	<ul style="list-style-type: none"> - Check wiring and replace, if required - Measure voltage on main PCB terminal 10 against N; replace PCB, if required • Replace blow-down pump • Clean cylinder and cylinder base carefully to ensure that no blocking will occur in the near future • Check blow-down pump, drainage system and steam cylinder for hardeners and clean
 	<p>120</p>	<p>Thermo switch</p> <p>One of the thermo switches has triggered</p>	<ul style="list-style-type: none"> • Thermo switch on steam cylinder cover has triggered due to lime coating on heating element • Capillary tube defective • Thermo switch on solid state relay has triggered due to blocked ventilation 	<ul style="list-style-type: none"> • Switch off power supply. Remove lime coating. Allow cool-down of steam cylinder. Push-back unblocking pin on thermo switch with needle-nose pliers or a screwdriver • Replace thermo switch • Switch off unit. Allow cool-down of heat sink. Restart humidifier operation.
  	<p>121</p>	<p>Water sensor</p> <p>Water sensor output signal not plausible</p>	<ul style="list-style-type: none"> • Water sensor is defective • Connecting hoses blocked 	<ul style="list-style-type: none"> • Replace water sensor • Clean hoses

Icons	Code	Error message	Possible cause	Counter measure
	122	<p>Max. level Maximum water level was achieved 5 times</p>	<ul style="list-style-type: none"> •Excessive air pressure in duct has impact on water in steam cylinder via steam hose. Water is pressed into drainage •Solenoid valve closing action imperfect. Cylinder water level rises though solenoid valve is not energised •Solenoid valve is permanently energised (water intake stops when unit is switched off) •Large amounts of residues influence or restrict cyclic blow-down. The additional water introduction caused by the optional SuperFlush rinse device may cause the max. level fault 	<ul style="list-style-type: none"> •Reduce air pressure •Check solenoid valve •Relay on main PCB stuck. Measure voltage across terminal 11 and N. Replace PCB, if required •Clean steam cylinder, cylinder base, water sensor tubing and drainage system

Icons	Code	Error message	Possible cause	Counter measure
	123	Steam down time Heater element (s) is/are driven but water level remains constant	<ul style="list-style-type: none"> • Heater element is defective • Phase loss (external circuit breaker has tripped or is defective) • No voltage supplied to heater element(s) • No proper main contactor switching action • Main contactor is not energised by PCB 	<ul style="list-style-type: none"> • Measure heater element resistance, replace heater element, if required. Typical resistance values are: SLH03 - 2.25kW/230V - 21.3...26.1Ω SLH06 – 4.5kW/400V – 32.3...39.5Ω SLH09 – 6,75kW/400V - 21.5...26.3Ω SLH15 – 3.8kW/400V – 38.2...46.8Ω (3x) SLH25 – 6.3kW/400V – 23.1...28.2Ω (3x) SLH40 – 6.3kW/400V – 23.1...28.2Ω (3x) + 3.8kW/400V – 38.2...46.8Ω (3x) SLH50 – 6.3kW/400V – 23.1...28.2Ω (6x) • Check circuit breaker, find reason for tripping • Check wiring, measure voltage • Check and replace main contactor, if required • Verify voltage across PCB terminal 9 and N
	124	Main contactor coil Voltage detected across coil though main contactor is not driven by control logic	<ul style="list-style-type: none"> • Relay K4 on main PCB is stuck 	<ul style="list-style-type: none"> • Replace relay
	210	R.h. sensor Humidity sensor signal implausibility	<ul style="list-style-type: none"> • Sensor cable defective • Sensor defective 	<ul style="list-style-type: none"> • Check sensor cable • Replace sensor
	ErL	Error Link no communication between mainboard and display	<ul style="list-style-type: none"> • Mainboard or display unit defective 	<ul style="list-style-type: none"> • Replace mainboard or display unit

12.2 Table of functional disruptions

Problem	Possible cause for faulty situation	Counter measure
Set humidity level not reached	<ul style="list-style-type: none"> • Output limitation parameter setting impedes full power output • Nominal unit output insufficient • Phase failure or defective heater element(s) • Thermo switch has triggered • Lengthy steam hose layout crossing cold and drafty rooms may lead to increased condensate formation • Improper steam manifold installation may cause condensate formation within air duct • Control signal not properly selected or software setting mismatch • Excessive pressure in duct system caused by e.g. water bags or partly blocked steam pipes (max. overpressure is 1200 Pa) 	<ul style="list-style-type: none"> • Check 1-1 parameter setting • Check unit technical data, air-flow and secondary airflow • Check circuit breakers and heater element(s) • Switch off power supply. Push-back unblocking pin on thermo switch with needle-nose pliers or a screwdriver • Change unit installation location allowing for shorter steam hose. Insulate steam hose • Check steam manifold position within total system and installation correctness • Check control signal and „1-2“ parameter setting • Eliminate particular cause(s)
Excessive humidity	<ul style="list-style-type: none"> • A steam output limitation setting that is too high may result in poor control performance and even condensate formation in ducts • Control signal not properly selected or software setting mismatch 	<ul style="list-style-type: none"> • Check „1-1“ parameter setting • Check control signal and „1-2“ parameter setting
Water collects on bottom plate	<ul style="list-style-type: none"> • Cylinder improperly reassembled following maintenance: <ul style="list-style-type: none"> - O-ring not replaced, defective or not in place - Flange (tongue and groove) damaged - Flange improperly composed - Mineral deposits in flange area • Cylinder improperly inserted in cylinder base • Water cannot drain freely when pumped from cylinder 	<ul style="list-style-type: none"> • Clean cylinder and assemble / install properly • Using moistened new O-ring, insert steam cylinder properly into cylinder base • Make sure drain is unobstructed

Problem	Possible cause for faulty situation	Counter measure
Water leaks from steam cylinder upper part	<ul style="list-style-type: none"> • Hose clamps on steam and/or condensate hose not tightened • Steam hose adapter not properly fit or o-ring not replaced 	<ul style="list-style-type: none"> • Tighten clamps • Replace O-ring (if required) and ensure proper adapter installation
No steam production despite the steam humidifier being switched on. Display not illuminated.	<ul style="list-style-type: none"> • Defective F1 and/or F2 fuses (1.6 A each) • L3 phase failure (ext. circuit breaker has tripped or is defective) • device load circuit breaker has tripped 	<ul style="list-style-type: none"> • Check micro fuses and replace, if required • Replace breaker and investigate possible causes • Switch on breaker. If problem persists, check for reason
Blow-down pump works but not water is drained	<ul style="list-style-type: none"> • Steam cylinder and/or drainage system blocked 	<ul style="list-style-type: none"> • Clean cylinder base and/or drainage system, respectively
Cylinder is fully drained after partial blow-down despite switched-off pump	<ul style="list-style-type: none"> • Vent pipe is blocked 	<ul style="list-style-type: none"> • Clean venting bore or replace vent pipe adapter
<p>No steam exit from steam manifold</p> <p>Water exits periodically from drain hose without pump switched on</p>	<ul style="list-style-type: none"> • Steam pipe improperly laid (water bag). • Excess pressure in duct system (max. overpressure is 1200 Pa/.17 psi) 	<ul style="list-style-type: none"> • Rerun steam hose according to guide lines • Consult your expert dealer if problem persists

13. Declaration of conformity

EU Konformitätserklärung EU Declaration of Conformity

Hersteller / Manufacturer: HygroMatik GmbH

Anschrift / Address: Lise-Meitner-Straße 3, D-24558 Henstedt-Ulzburg, Germany

Produktbezeichnung: / Product description **StandardLine Heizkörper (SLH):**
SLH03, SLH06, SLH09, SLH15, SLH25, SLH40, SLH50

Die bezeichneten Produkte stimmen in der von uns in Verkehr gebrachten Ausführung mit den Vorschriften folgender Europäischer Richtlinien überein:

The products described above in the form as delivered are in conformity with the provisions of the following European Directives:

- 2014/30/EU** Richtlinie des Rates zur Angleichung der Rechtsvorschriften der Mitgliedstaaten über die elektromagnetische Verträglichkeit.
Council Directive on the approximation of the laws of the Member States relating to electromagnetic compatibility.
- 2014/35/EU** Richtlinie des Rates zur Angleichung der Rechtsvorschriften der Mitgliedstaaten betreffend elektrische Betriebsmittel zur Verwendung innerhalb bestimmter Spannungsgrenzen.
Council Directive on the approximation of the laws of the Member States related to electrical equipment designed for use within certain voltage limits.

Die Konformität mit den Richtlinien wird nachgewiesen durch die Einhaltung folgender Normen:
Conformity to the Directives is assured through the application of the following standards:

Referenznummer:	Ausgabedatum:	Referenznummer:	Ausgabedatum:
<i>Reference Number:</i>	<i>Edition:</i>	<i>Reference Number:</i>	<i>Edition:</i>
DIN EN 61000-6-2	2006-03	DIN EN 60335-1	2012-10
DIN EN 61000-6-3	2011-09	DIN EN 60335-1 Ber.1	2014-04
DIN EN 62233	2008-11	DIN EN 60335-2-98	2009-04
DIN EN 62233 Ber.1	2009-04		

Das Produkt entspricht den Anforderungen des deutschen Produktsicherheitsgesetzes ProdSG hinsichtlich der Gewährleistung von Sicherheit und Gesundheit. Produktänderungen nach Auslieferung können zum Verlust der Konformität führen.

The requirements of the German Product Safety Law ProdSG regarding the ensurance of safety and health are met. Product modifications after delivery may result in a loss of conformity.

Henstedt-Ulzburg, den / the 29.09.2017

HygroMatik GmbH



Dirc Messing
Geschäftsführer / General Manager



i.V. Frank Michaelsen
Leitung Technik / Head of Engineering

Diese Erklärung bescheinigt die Übereinstimmung mit den genannten Richtlinien, ist jedoch keine Zusicherung von Eigenschaften. Die Sicherheitshinweise der mitgelieferten Produktdokumentation sind zu beachten.
This declaration certifies the conformity to the specified directives but contains no assurance of properties. The safety documentation accompanying the product shall be considered in detail.

14. Spare Parts

*	SLH03	SLH06	SLH09	SLH15	SLH25	SLH40	SLH50	Article No.	Description
Steam generation									
16	1							SP-03-01010	Steam cylinder SLH03 CY08 208-240V, incl. O-ringset
16		1						SP-03-01040	Steam cylinder SLH06 CY08 208-240V, incl. O-ringset
16		1						SP-03-01041	Steam cylinder SLH06 CY08 380-415V, incl. O-ringset
16			1					SP-03-01070	Steam cylinder SLH09 CY08 380-415V, incl. O-ringset
16				1				SP-04-01011	Steam cylinder SLH15 CY17 380-415V, incl. O-ringset
16					1			SP-04-01040	Steam cylinder SLH25 CY17 380-415V, incl. O-ringset
16						1		SP-06-01010	Steam cylinder SLH40 CY45 380-415V, incl. O-ringset
16							1	SP-06-01040	Steam cylinder SLH50 CY45 380-415V, incl. O-ringset
	1	1	1					AC-03-01000	O-ringset (Pos. 3, 17, 31, 33, 34, 35)
				1	1			AC-04-01000	O-ringset (Pos. 3, 17, 31, 33, 34, 35)
						1	1	AC-06-01000	O-ringset (Pos. 3, 17, 31, 33, 34, 35)
4	1							SP-03-01100	Heating element CY08 3kg 230V, incl. gaskets
4		1						SP-03-01101	Heating element CY08 6kg 230V, incl. gaskets
4		1						SP-03-01102	Heating element CY08 6kg 400V, incl. gaskets
4			1					SP-03-01105	Heating element CY08 9kg 400V, incl. gaskets
4				3		3		SP-07-01101	Heating element CY17/45 5kg 400V, incl. gasket
4					3	3	6	SP-07-01104	Heating element CY17/45 8,4kg 400V, incl. gasket
5	1	1	1	1	1	2	2	B-2205031	Thermal circuit breaker steam cylinder incl. incl. gasket, clips
27	1	1	1	1	1	1	1	CN-07-01010	Water level sensor complete with cable
1	1	1	1					E-2209018	Adapter for Steam hose for cylinder CY08 DN40-25
1				1	1	2	2	E-2209008	Adapter for Steam hose for cylinder CY17/45 DN40-40
2	1	1	1	1	1	2	2	E-2209002	Clip for adapter
Water feed									
25	1	1	1					WF-03-00010	Solenoid valve SLH03-09 220-240V 0,2 - 10bar with mounting set
25				1	1			WF-04-00010	Solenoid valve SLH15-25 220-240V 0,2 - 10bar with mounting set
25						1	1	WF-06-00010	Solenoid valve SLH40-50 220-240V 0,2 - 10bar with mounting set
	1	1	1					WF-03-01001	Water feed hose system incl. Cylinder base and mounting set
				1	1			WF-04-01001	Water feed hose system incl. Cylinder base and mounting set
						1	1	WF-06-01001	Water feed hose system incl. Cylinder base and mounting set
56	1	1	1	1	1	1	1	B-2304031	Water inlet hose connection, 0.6m 3/4"
Water drain									
	1	1	1					B-2425005	Pump-drain-hose-system (Pos. 6, 14, 15, 30, 31)
				1	1	1	1	B-2425009	Pump-drain-hose-system (Pos. 6, 14, 15, 30, 31)
	1	1	1	1	1	1	1	B-2404027	Drain pump without mounting set, with 2 o-rings
	1	1	1	1	1	1	1	B-2424014	Mounting set for drain pump

*	SLH03	SLH06	SLH09	SLH15	SLH25	SLH40	SLH50	Article No.	Description
									Electrics
	1	1	1					E-2510010	Main contactor 25A, K1.1- SLH03-09
				1	1			E-2510020	Main contactor 32A, K1.1- SLH15-25
						1	1	E-2510020	Main contactor 32A, K1.2 - SLH40-50
						1	1	E-2510030	Main contactor 50A, K1.1- SLH40-50
	1	1	1					CN-03-01000	Solid state relay for SLH03-09 incl. heatsink & temp. limiter
				1	1	1	1	CN-07-01000	Solid state relay for SLH15-50 incl. heatsink & temp. limiter
	1	1	1					WR-03-01000	Connector e- compartment - water compartment, plug + socket
				1	1	2	2	WR-07-01000	Connector e- compartment - water compartment, plug + socket
	1	1	1	1	1	1	1	CN-07-00000	Mainboard incl. Plug
59	1	1	1	1	1	1	1	E-0510010	Display
	1	1	1	1	1	1	1	E-0510012	Clip for display
51	1	1	1	1	1	1	1	E-2502412	Control switch, double pole, middle position = "0"
									Accessories
70								E-2604012	Steam hose DN25, per m
70								E-2604013	Steam hose DN40, per m
57								E-2420423	Drain hose 1 1/4", per m
								E-2604002	Condensate hose DN12, per m
								E-2404004	Steam hose clamp DN25
								E-2604016	Steam hose clamp DN40
								E-2404010	Clamp for drain hose 1 1/4"
								E-8501064	Condensate hose clamp
								E-2604042	Connectors for steam distribution T- piece DN25, stainless steel
								E-2604023	Connectors for steam distribution T- piece DN40, stainless steel
								E-2604021	Connectors for condensate T- piece DN12

For ordering spare parts, a template can be found on the www.hygroamatik.com website under the „Contact“ tab. Your spare parts order may as well be directed per e-mail to the HygroMatik main office using the address hy@hygroamatik.de.

Please make sure to specify your unit model and serial number.

15. Technical specifications

Technical specifications StandardLine Heat							
Unit type	SLH03	SLH06	SLH09	SLH15	SLH25	SLH40	SLH50
Steam output [kg/h]	2,7-3,3	5,5-6,5	8,2-9,8	13,7-16,4	22,7-27,1	36,5-43,5	45,5-54,3
Electrical supply ⁽¹⁾	220-240V /1Ph /50-60Hz		380-415V /3Ph /50-60Hz				
Power rating [kW]	2,1-2,4	4,1-4,9	6,2-7,3	10,3-12,3	17,1-20,3	27,3-32,6	34,1-40,7
Nominal current [A]	9,4-10,2	18,7-20,4	16-17,5	15,6-17,1	25,9-28,3	41,5-45,4	51,8-56,6
Circuit Protection [A]	1 x 16	1 x 25	3 x 16	3 x 20	3 x 32	3 x 50	3 x 63
Number of steam cylinder	1						
Control	StandardLine-mainboard with capacitive touch display						
Separate control voltage ⁽²⁾	220-240V /N /1,6A						
Steam hose connection [mm]	1 x 25		1 x 40		2 x 40		
Empty weight [kg]	14,0		23,0		45,0		
Max. filling volume [l]	5,0		14,0		36,0		
Operation weight [kg]	19,0		38,0		82,0		
Width ⁽⁶⁾ [mm]	350		425		590		
Height ⁽⁶⁾ [mm]	535		695		790		
Depth ⁽⁶⁾ [mm]	245		320		415		
Water connection	Fully demineralized water / cleaned condensate / partially softened Water / tap water (different qualities) 1 to 10bar, with 3/4" connection for external thread						
Drain water connection	Connection Ø 1 1/4"						

⁽¹⁾ Other voltages upon request.

⁽²⁾ Internal control voltage upon request

⁽⁶⁾ Outer dimensions of width and depth. Height incl. drain connection.

This page intentionally left blank

This page intentionally left blank

16. Exploded view

The figure following shows the SLH25 model composition. The number of cylinders and heater elements vary with respect to the complete SLH series.

The index numbers in the figure correspond to the spare parts list.

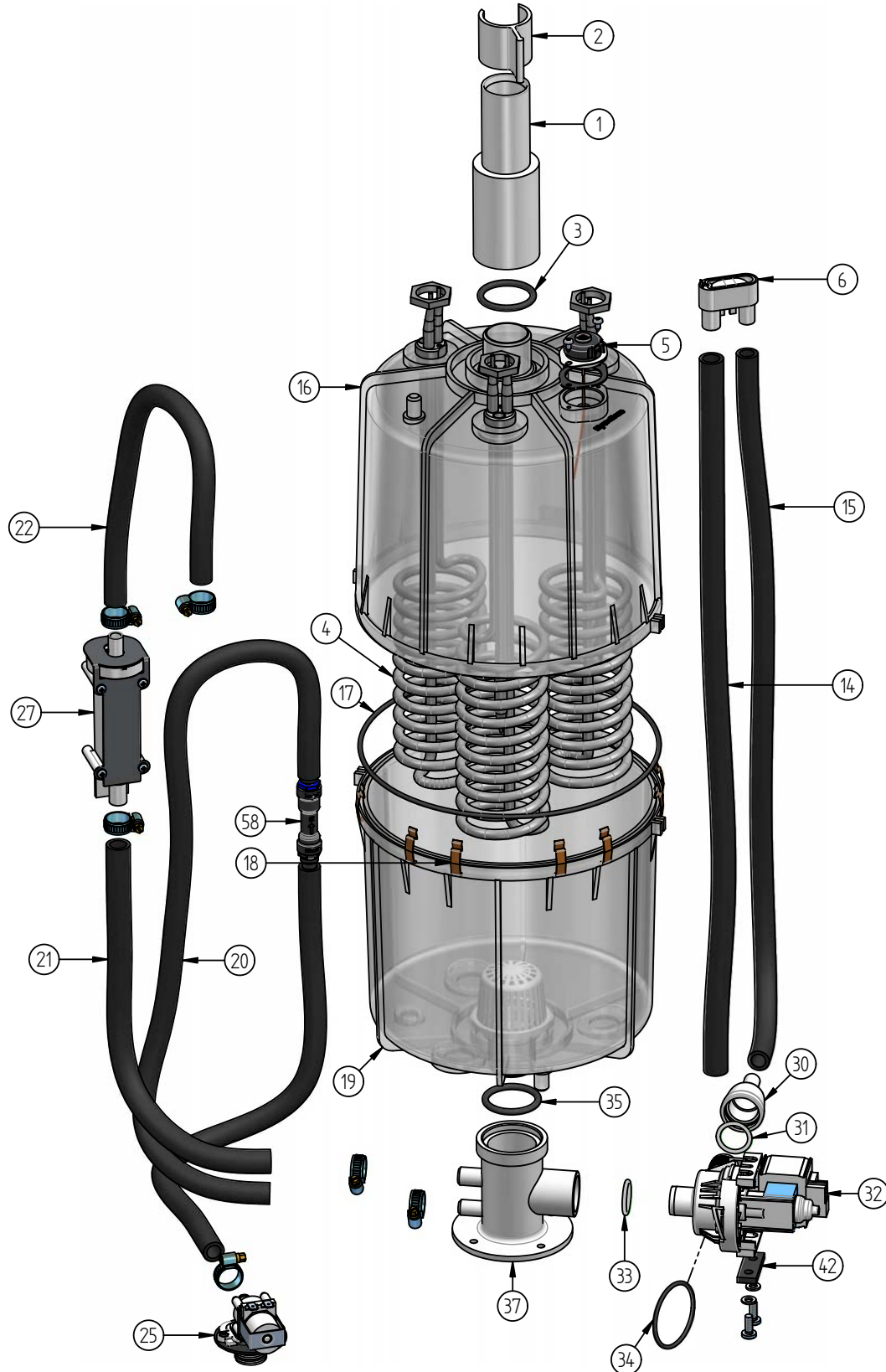

17. View of housing

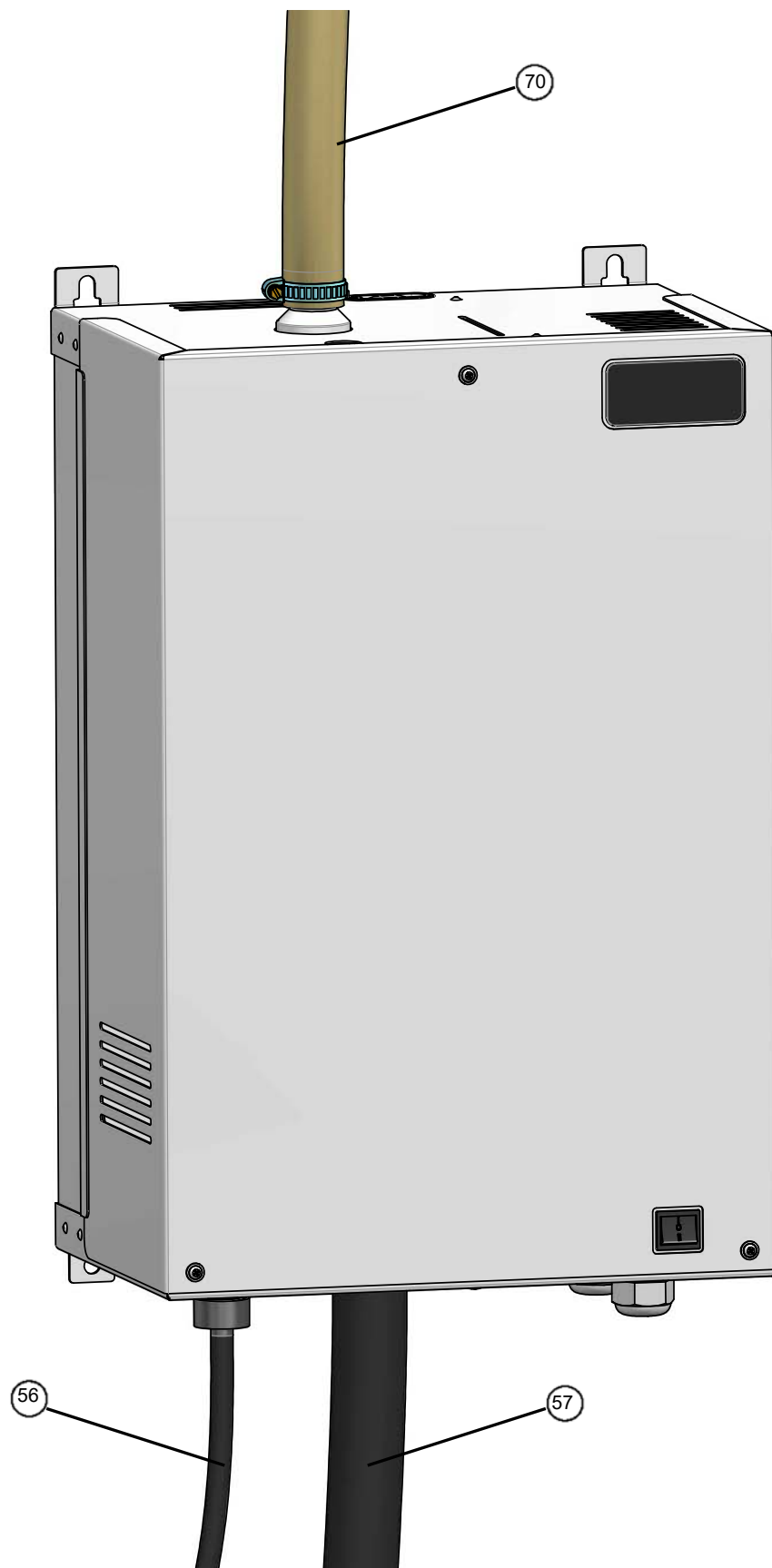

HYGROMATIK®

Lise-Meitner-Str.3 · D-24558 Henstedt-Ulzburg
Phone +49(0)4193/ 895-0 · Fax -33
eMail hy@hygromatik.de · www.hygromatik.com
member of **CAREL Group**