

Electrode Steam Humidifier StandardLine



**IMPORTANT: READ AND SAVE
THESE INSTRUCTIONS**



SLE.EN
E-8881152

Certain computer programs contained in this product [or device] were developed by HygroMatik GmbH ("the Work(s)").

Copyright © HygroMatik GmbH [12.11.2018]

SLE 02/05/10/15/20/30/45/65

All Rights reserved.

Current version of this manual to be found on: www.hygromatik.com

HygroMatik GmbH grants the legal user of this product [or device] the right to use the Work(s) solely within the scope of the legitimate operation of the product [or device]. No other right is granted under this licence. In particular and without prejudice to the generality of the foregoing, the Work(s) may not be used, sold, licensed, transferred, copied or reproduced in whole or in part or in any manner or form other than as expressly granted here without the prior written consent of HygroMatik GmbH.

Information in this manual is subject to change or alteration without prior notice.

 WARNING

Risk of electrical shock!

Hazardous electrical voltage!

All electrical work to be performed by certified expert staff (electricians or expert personnel with equivalent training) only.

1. Introduction	6
1.1 Typographic Distinctions	6
1.2 Documentation	6
1.3 Symbols in Use	6
1.3.1 Specific Symbols related to Safety Instructions	6
1.3.2 General Symbols	6
1.4 Intended Use	7
2. Safety Instructions	8
2.1 Guidelines for Safe Operation	8
2.1.1 Scope	8
2.1.2 Unit control	8
2.1.3 Unit Operation	8
2.1.4 Mounting, dismantling, maintenance and repair of the unit	9
2.1.5 Electrical	9
2.2 Disposal after dismantling	9
3. Transport	10
3.1 Overview	10
3.2 Packing	10
3.3 Interim Storage	10
3.4 Check for Complete and Correct Delivery of Goods	10
4. Functional Description and Device Composition	11
4.1 Mode of Action	11
4.2 Mechanical construction	11
4.3 Operating sequence	12
5. Mechanical installation	13
5.1 Environment Parameters to be met and Mounting Recommendations	13
5.1.1 Dimensions and Mounting Directions	14
5.2 Unit Installation Check	17
5.3 Absorption Distance BN	18
5.3.1 Determining the Absorption Distance	18
5.3.2 Absorption Distance Nomogram	19
5.4 Steam Manifold	20
5.4.1 General installation guidelines	20
5.4.2 Recommendations for dimensioning	20
5.5 Steam line and condensate hose layout	23
5.5.1 Guide lines for steam line design	23
5.5.2 Condensate hose layout	23
5.5.3 Steam line and condensate hose installation types	24
6. Water connection	25
6.1 Operation with softened water	25
6.2 Water supply	26
6.3 Water discharge	26
6.4 Water connections final check	27

7. Electrical connection	28
7.1 Electrical installation approach	28
7.2 Cable connections	29
7.3 Safety interlock	30
7.4 Control signal	30
7.4.1 1-step operation	30
7.4.2 Operation with an active humidity sensor or external controller	30
7.4.3 Wiring for control signal and safety (interlock) system for multiple units	31
7.5 Connection diagram	31
7.6 Electrical installation check list	31
8. Commissioning	32
9. Maintenance	33
9.1 General	33
9.1.1 Safety instructions for maintenance	33
9.2 Maintenance frame work	34
9.3 Removal and reinstallation of the steam cylinder	35
9.4 Steam cylinder, electrodes and cylinder base cleaning	39
9.5 Checking cable connections	39
9.6 Solenoid valve removal/reinstallation and fine filter cleaning	40
9.7 Cleaning of blow-down pump	41
9.8 Inspection of hoses	42
9.9 Electrode replacement	42
9.10 Functional check	43
9.11 Finishing maintenance	43
10. Dismantling	44
11. Unit Control	45
11.1 General description	45
11.1.1 Wiring Diagrams	46
11.1.2 Mainboard inputs and outputs	50
11.2 Control operation	51
11.2.1 Principal user guidance	51
11.2.2 Menu structure	51
11.2.3 Menu tree	52
11.3 The control panel	53
11.4 Navigation within a menu	54
11.5 Tabular representation of reading value list and provider level submenus	55
11.5.1 The reading value list	55
11.5.2 Provider level submenus and relating parameters	56
11.6 Exemplary variation of a parameter setting	59
11.7 Detailed description of the user level reading values and settings	60
11.8 Detailed parameter descriptions	63
12. Trouble shooting	68
12.1 Error handling	68
12.1.1 Table of possible faults and related error codes	68

12.2 Table of functional disruptions	72
13. Declaration of Conformity	75
14. Spare Parts	76
15. Technical specifications	79
16. Exploded view	80
17. View of housing	81

1. Introduction

Dear Customer,

Thank you for choosing a HygroMatik steam humidifier.

HygroMatik steam humidifiers represent the latest in humidification technology.

In order to operate your HygroMatik steam humidifier safely, properly and efficiently, please read these operating instructions.

Employ your steam humidifier only in sound condition and as directed. Consider potential hazards and safety issues and follow all the recommendations in these instructions.

If you have additional questions, please contact your expert dealer.

For all technical questions or spare parts orders, please be prepared to provide unit type and serial number (see name plate on the unit).

1.1 Typographic Distinctions

- Preceded by a bullet: general specifications
 - » Preceded by an arrow: procedures for servicing or maintenance which should or must be performed in the indicated order
 - ☑ Installation step which must be checked off.
- italics* Terms used with graphics or drawings

1.2 Documentation

Retention

Please retain these operating instructions in a secure, always accessible location. If the product is resold, turn the documentation over to the new operator. If the documentation is lost, please contact HygroMatik.

Versions in Other Languages

These operating instructions are available in several languages. If interested, please contact HygroMatik or your HygroMatik dealer.

1.3 Symbols in Use

1.3.1 Specific Symbols related to Safety Instructions

According to ANSI Z535.6 the following signal words are used within this document:

▲ DANGER

DANGER indicates a hazardous situation which, if not avoided, will result in death or serious injury.

▲ WARNING

WARNING indicates a hazardous situation which, if not avoided, could result in death or serious injury.

▲ CAUTION

CAUTION indicates a hazardous situation which, if not avoided, could result in minor or moderate injury.

NOTICE

NOTICE is used to address practices not related to physical injury.

1.3.2 General Symbols

Please note

This symbol is used whenever a situation requires special attention beyond the scope of safety instructions.

1.4 Intended Use

HygroMatik electrode steam humidifiers serve for steam production based on tap water or partially softened water.

Only use supply water featuring a conductivity of 125 to 1250 $\mu\text{S}/\text{cm}$.

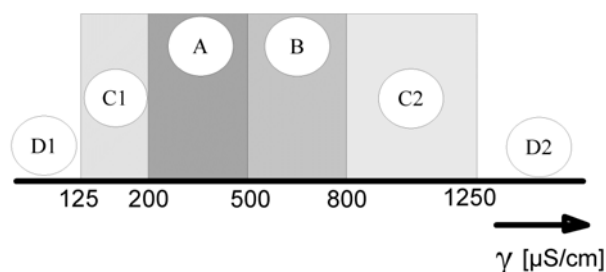

D1: Lower threshold

C1: Range of reduced conductivity
(adjustment required)

A: Normal Tap water

B: Range of increased conductivity

C2: Range of high conductivity
(adjustment required)

D2: Upper threshold

In the C1 and C2 ranges, adaptation of the periodic blow-down frequency may be required. Pls. refer to the partial and full blow-down parameter descriptions given in the blow-down submenu chapter as well as in the glossary.

Proper usage also comprises the adherence to the conditions specified by HygroMatik for:

- installation
- dismantling
- reassembly
- commissioning
- operation
- maintenance
- disposal

Only qualified and authorised personnel may operate the unit. Persons transporting or working on the unit must have read and understood the respective parts of this manual, especially the „Safety Instructions“ given in chapter 2. Additionally, operating personnel must be informed of any possible hazards. A copy of the manual is to be stored at the unit's operational location (or near the unit).

By construction, HygroMatik steam humidifiers are not qualified for exterior application.

⚠ WARNING

Risk of scalding!

Steam with a temperature of up to 100 °C (212 °F) is produced.

Do not inhale steam directly!

2. Safety Instructions

These safety instructions are required by law. They promote workplace safety and accident prevention.

2.1 Guidelines for Safe Operation

2.1.1 Scope

Comply with the accident prevention regulation „DGUV Regulation 3“ to prevent injury to yourself and others. Beyond that, national regulations apply without restrictions.

2.1.2 Unit control

Do not perform any work which compromises the safety of the unit. Obey all safety instructions and warnings present on the unit.

In case of a malfunction or electrical power disruption, switch off the unit immediately and prevent a restart. Repair malfunctions promptly.

▲ WARNING

Restricted use.

IEC 60335-1 stipulates as follows:

This device may be used by children of eight years of age and above as well as by persons with reduced physical, sensory or mental capabilities or lack of experience and knowledge so long as they are supervised or have been instructed regarding the safe use of the device and understand the hazards that may result from it. Cleaning and user maintenance of the unit must not be undertaken by children without supervision.

2.1.3 Unit Operation

▲ WARNING

Risk of scalding!

Uncontrolled hot steam escape in case of leaking or defective components possible. Switch off unit immediately.

NOTICE

Risk of material damage!

The unit may be damaged if switched on repeatedly following a malfunction without prior repair.

Rectify defects immediately!

The unit must not be operated on a DC power supply.

The unit may only be used connected to a steam pipe that safely transports the steam.

Regularly check that all safety and monitoring devices are functioning normally. Do not remove or disable safety devices.

2.1.4 Mounting, dismantling, maintenance and repair of the unit

NOTICE

The HygroMatik steam humidifier is IP20 protected. Make sure that the unit is not object to dripping water in the mounting location.

Installing a humidifier in a room without water discharge requires safety devices to protect against water leakages.

- Use genuine spare parts only
- After any repair work, have qualified personnel check the safe operation of the unit
- Attaching or installing of **additional components** is permitted only with the **written consent** of the manufacturer

2.1.5 Electrical

⚠ WARNING

Risk of electrical shock!

Hazardous electrical voltage!

Any work on the electrical system to be performed by certified expert staff (electricians or expert personnel with comparable training) only.

Disconnect unit components from electrical power supply prior to work.

After electrical installation or repair work, test all safety mechanisms (such as grounding resistance).

NOTICE

Use only original fuses with the appropriate amperage rating.

Regularly check the unit's electrical equipment. Promptly repair any damage such as loose connections or burned wiring.

Responsibility for intrinsically safe installation of the HygroMatik steam humidifiers is incumbent on the installing specialist company.

2.2 Disposal after dismantling

NOTICE

The operator is responsible for the disposal of unit components as required by law.

3. Transport

3.1 Overview

Please note

Proceed carefully when transporting the steam humidifier in order to prevent damage due to stress or careless loading and unloading.

3.2 Packing

Please note

Pay attention to the icons affixed to the packing box.

3.3 Interim Storage

Store the unit in a dry place and protect from frost and strong sunlight.

3.4 Check for Complete and Correct Delivery of Goods

Upon receipt of the unit, confirm that:

- model and serial number on the name plate match those specified in the order and delivery documents
- the equipment is complete and all parts are in perfect condition

Please note

In case of damage from shipment and/or missing parts, immediately notify the carrier or supplier in writing.

Time limits for filing freight claims with shipping companies are*:

Shipping company	After receipt of goods
Carriers	no later than 4 days
Parcel service	immediately

* Time limits for some services subject to change.

4. Functional Description and Device Composition

4.1 Mode of Action

Making use of the frictional heat caused by current flow in a water tank

The HygroMatik humidifier utilizes the conductivity normally present in tap water for steam production. Electrodes inside an enclosed steam cylinder are immersed directly into the tap water. They are connected to the alternating current.

The conductivity of the water generates an electric current between the electrodes. In this way, the electric power supplied is converted directly into heat without energy loss. The steam produced has a temperature of about 100°C (212°F) with minimal excess pressure ("pressureless steam"). It is largely free of minerals and germ-free. Mineral deposits typically remain behind in the cylinder.

4.2 Mechanical construction

The StandardLine humidifiers are designed for wall mounting. For maintenance purposes, the steam cylinders are separable in the middle.

Please note

Starting with the manufacturing date of 11/2018, the steam humidifiers SLE45 and SLE65 make use of a modified steam cylinder that are separable in the upper part of the wall. When replacing the steam cylinder, the new cylinders with the designation „CY45/2“ may be incorporated in the older units as well. With the steam cylinder modification also the electrodes have changed. The new electrodes only fit in the new steam cylinders.

The cylinders CY45/2 allow for unit operation without a cylinder star even in case of high conductivity of the cylinder water.

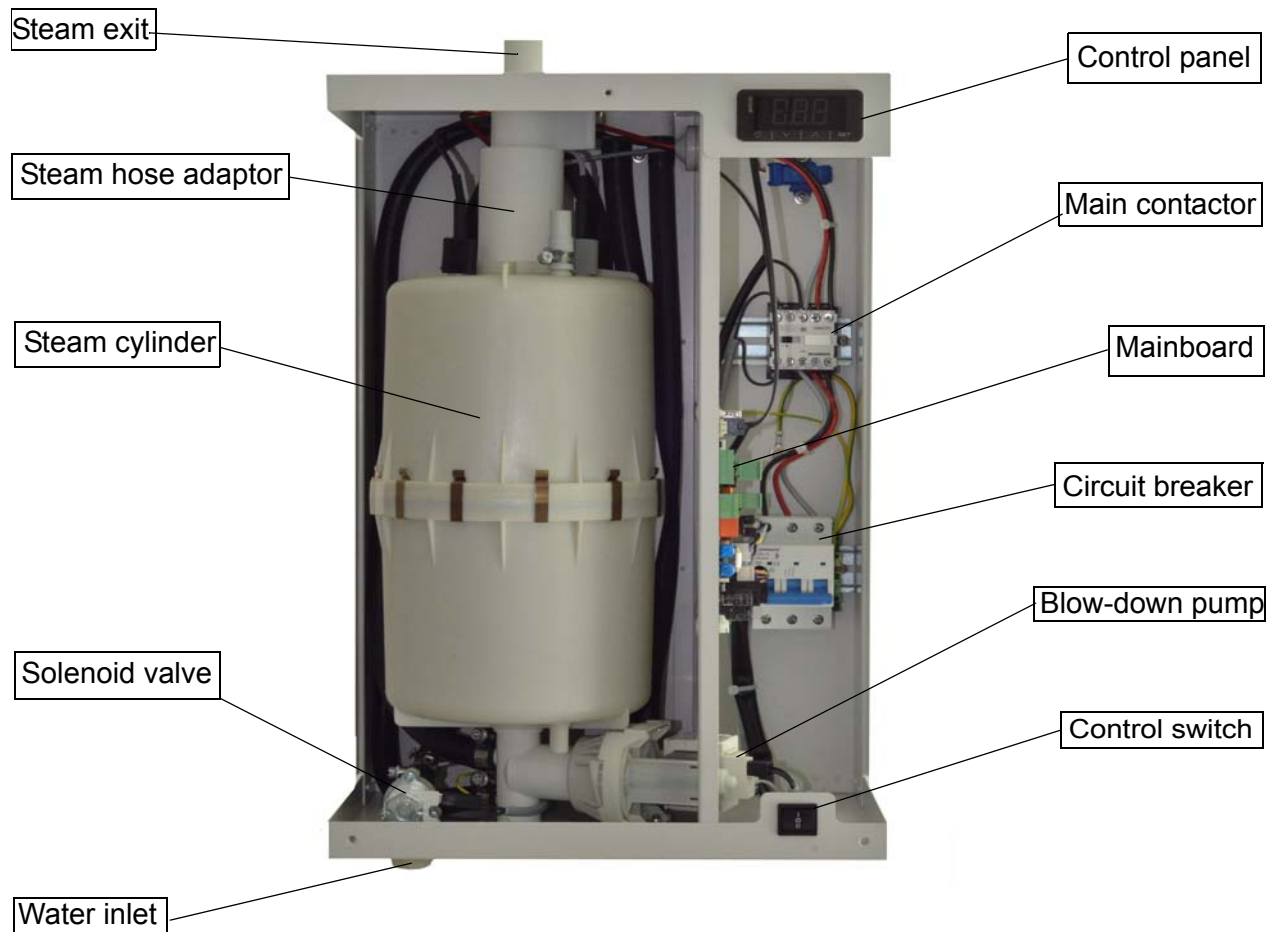

4.3 Operating sequence

By pressing the control switch („Pos. I“) the humidifier is turned on. When the controller specifies an increase in humidity, the main contactor is switched on and the electrodes (48^{*)} are supplied with power. The water inlet solenoid valve (25^{*)} feeds water into the steam cylinder (16^{*)}.

As soon as the electrodes are immersed, the current begins to flow. The water is now heated. When the pre-selected output is reached, the control turns off the solenoid valve and interrupts the water supply.

After a short period of heating up, the water between the electrodes starts boiling and then vaporizes. The vaporization lowers the water level in the steam cylinder, reducing the output provided. To compensate for that, fresh water is fed into the steam cylinder every now and then by opening the intake solenoid valve.

Humidifier power usage is continuously monitored. With a cold start-up, the nominal current increases to 128% in order to achieve quick-start output parameters. This activates the electronic overflow limiter which causes a partial draining of the cylinder. This reduces the immersed surface area of the electrodes, lowering power usage.

The concentration of dissolved salts increases over time, which can lead to a rise in the conductivity of the water. If this continues, conductivity may increase until a short circuit occurs. This could damage the unit, but in any case would significantly reduce the life span of the electrodes.

For this reason, regular, periodic blow-downs of some of the concentrated water are very important. Following this procedure as recommended provides stable cylinder water conductivity as well as minimal water loss for the expected service life of the cylinder.

Water blow-down is performed by a blow-down pump (32^{*)}). The functioning of the blow-down pump is continuously monitored during operation. If the pump is damaged, the steam humidifier shuts down.

With normal water quality the blow-down loss rate lies between 7 and 15 % of the amount of steam produced. Depending on water quality, a full steam cylinder blow-down is run every 3 to 8 days.

Mineral deposits settle in the open area below the electrodes and are removed through periodic maintenance. The blow-down pump itself has wide openings and can flush out smaller pieces of mineral deposit. This extends the service life of the unit and reduces the required maintenance interval.

On blow-down, water flows from the pump into the drainage system.

For maintenance purposes, the cylinder water may be pumped out by pressing and holding the control switch in the „II“ position.

Monitoring max. level

A sensor electrode (10^{*)}) monitors the maximum water capacity of the cylinder. When the water level reaches the sensor electrode, the water supply is interrupted. This can occur when the water has low conductivity or when the electrodes are worn out. In the case of low water conductivity, however, this state usually lasts only a short time. The built-in control and the large area electrodes combine to produce a rapid rise in conductivity by increasing the concentration of the water.

^{*)} numbers indicated correspond with those in the exploded view in the „Exploded view“ chapter.

5. Mechanical installation

▲ WARNING

Risk of foot injuries!

Prevent unit from dropping during installation!
Helping hand of a second person is advisable.

▲ WARNING

Risk of electrical shock!

Hazardous electrical voltage.
During installation, the unit must be disconnected from power supply.

5.1 Environment Parameters to be met and Mounting Recommendations

When selecting the installation site for the steam humidifier, take the following into account:

- The minimum clearances indicated in the fitting measures section must be observed in order to ensure adequate unit ventilation and allow for unobstructed access in case of maintenance
- Protection class IP20
- By design, HygroMatik steam humidifiers are not qualified for outdoor installation (electronical components and water-bearing parts may be damaged)
- Ambient temperature must lie between +5 and +40 °C (+41 and +104 °F) in order to protect the unit electronics against damage; frost may damage the steam cylinder, the solenoid valve and pump, as well as make hoses burst
- Relative humidity must not exceed 80 % r.h., since values beyond may lead to electronic malfunction or damage

- Installation in a closed room requires aeration and, eventually, temperature conditioning in order to meet the a.m. environmental conditions
- The steam humidifier should be installed as close as possible to the steam manifold. Optimum performance is only guaranteed when steam and condensate hoses are kept short
- Make use of existing water connections for supply and draining
- Hoses must be laid at a consistent 5 to 10 % incline/decline; sagging and kinking prevention is a must
- Mount the unit on a stable, preferably solid wall offering the bearing capacity required (s. unit technical specifications). If such a wall is not at hand, the unit may be attached to a stand bracket firmly bolted to the floor
- For proper functioning of the level control, plumb and level installation of the unit is required
- The steam humidifier rear panel heats up during operation to a maximum of 70 °C (158 °F). Take care that the construction on which the unit is to be mounted is not made of temperature-sensitive material

5.1.1 Dimensions and Mounting Directions

Table of dimensions

Model	X [mm/inch]	Y [mm/inch]	Z [mm/inch]	A [mm/inch]	B[mm/inch]
SLE 02	350/~13.8	375/~14.8	245/~9.6	295/~11.6	372/~14.7
SLE05-SLE10	350/~13.8	535/~21	245/~9.6	295/~11.6	535/~21
SLE15-SLE30	425/~16.7	695/~27.4	320/~12.6	370/~14.6	695/~27.4
SLE45-SLE65	590/~23.2	790/~31.1	415/~16.3	535/~21	787/~31

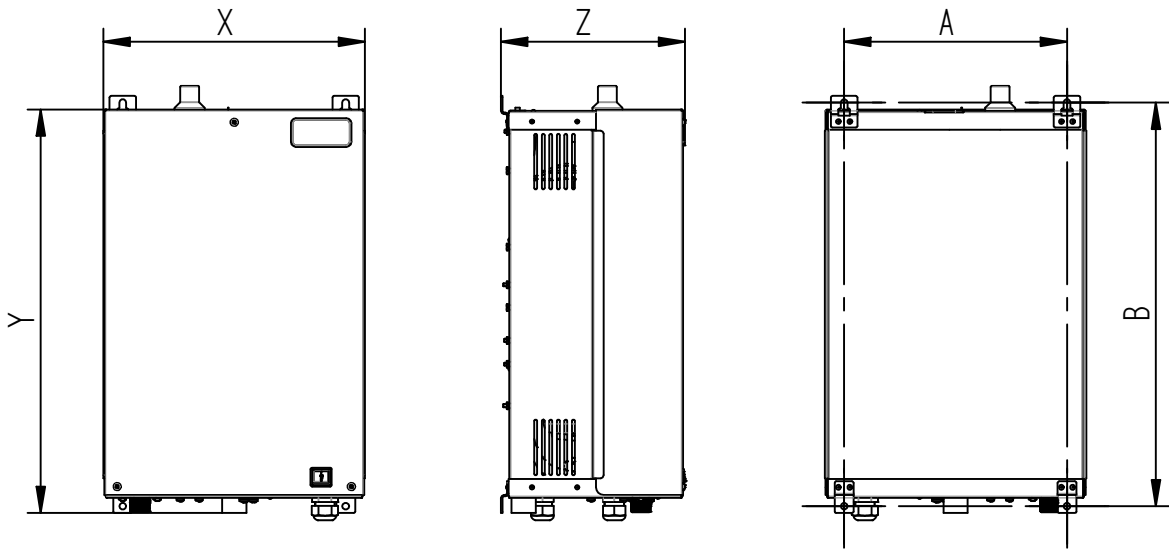

Detailed measurements under <https://www.hygromatik.com/files/pdf/hygromatik-standardline-dimensionsv11.pdf> .
 3D models under <https://www.hygromatik.com/en/downloads>

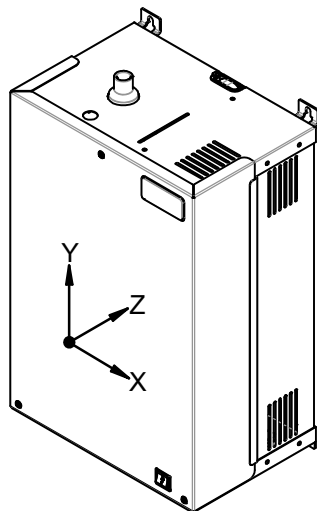

Wall clearances

When mounting the steam humidifier, the wall clearances shown in the fig. below must be obeyed:

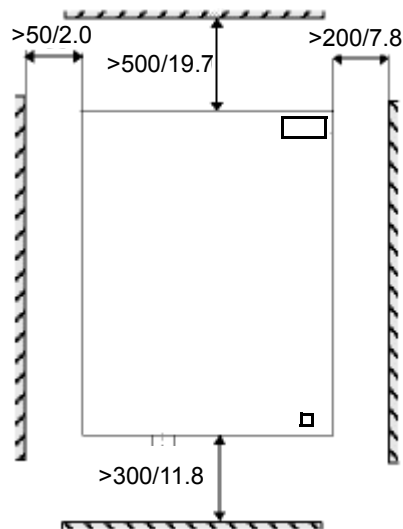

all measures in mm/inch

Mounting principle

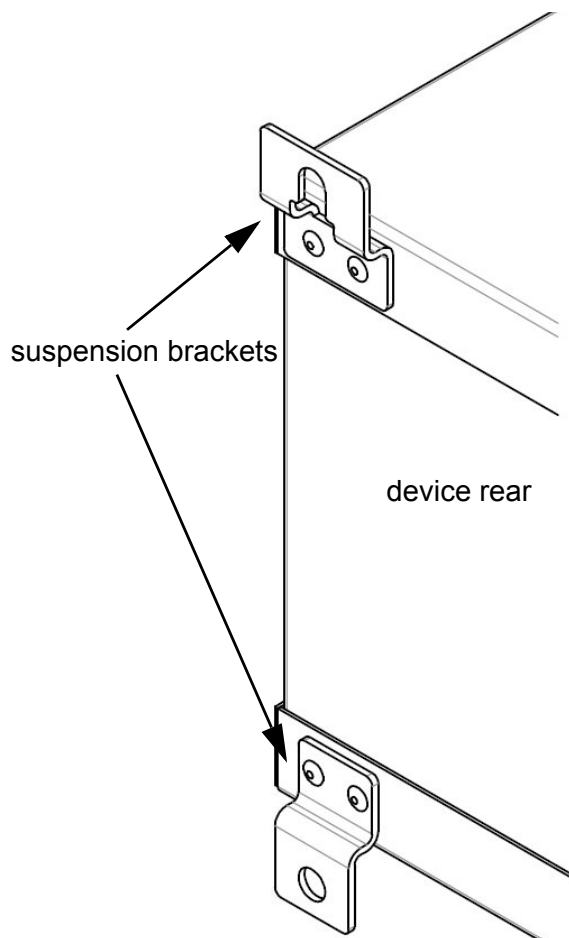

For wall mounting drill measures, please consult the table above (measure A). In case of no suitable wall available for mounting the unit, it is recommended that installation is made on brackets firmly anchored in the floor.

- » mark the holes for the upper suspension brackets screws.
- » drill holes and dowel.
- » screw in the supplied mounting screws; let the screws protrude approx. 12 mm/.5 inch from wall.
- » ensure firm fixation and load-carrying capacity of the mounted screws! hook in the unit and ensure safe suspension.
- » mark the holes for the lower suspension brackets screws.
- » remove the unit.
- » drill holes and dowel.
- » hook in the unit and mount the lower screws firmly.

Please note

To function properly, the steam humidifier must hang level and plumb.

Device connections:

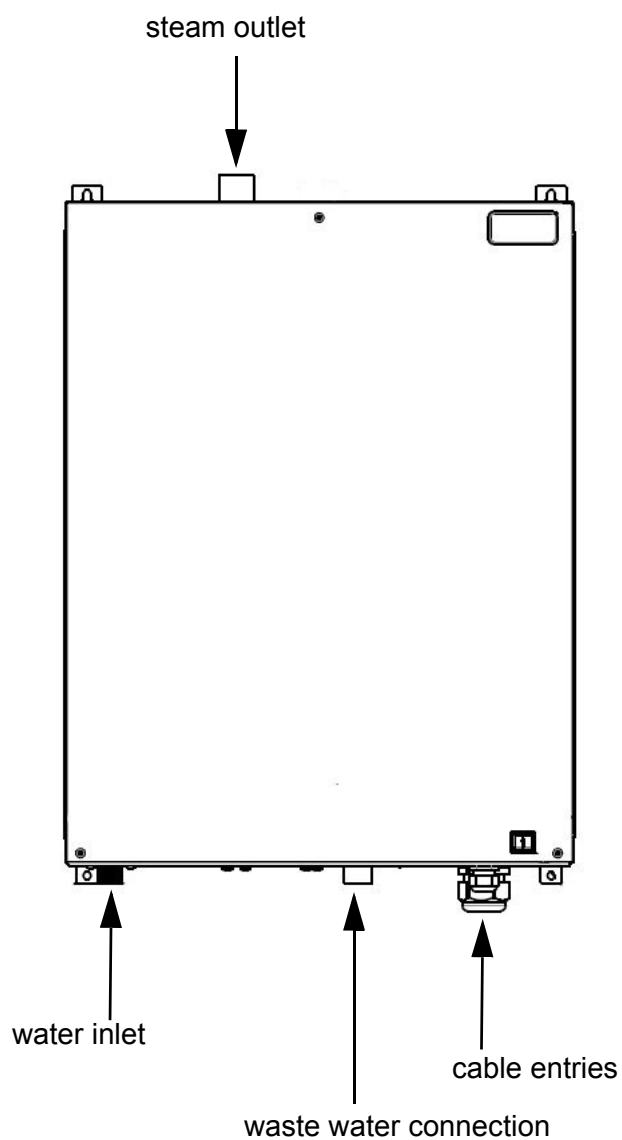

5.2 Unit Installation Check

Before start-up, pls. check proper unit installation following the list below:

- Unit perpendicularly aligned in both the vertical and horizontal axis ?
- All clearances obeyed?
- Steam hose installed with a 5 - 10 % minimum incline/decline (see chapter "Steam line") ?
- Condensate hose features a loop functioning as a steam barrier (see chapter „Condensate hose“) ?
- Steam manifold(s) properly positioned?
- All bolts and clamps properly tightened?
- Steam manifold(s) horizontally mounted and suspended on the free end, if required ?
- All seals (o-rings) in place?
- All ventilation slots on housing top unobscured?

5.3 Absorption Distance B_N

The "absorption distance" (B_N) is defined as the distance from the steam feed to where the steam is completely absorbed in the treated air. Within the absorption distance, steam is visible as mist in the air stream.

Condensation may occur on anything installed within the absorption distance.

Although steam outside the absorption distance (B_N) is completely absorbed, it is not yet evenly diffused in the duct. If you plan to install any parts or devices inside the absorption distance, such as sensors or elbows, we recommend increasing the absorption distance using the formulae below. The absorption distances required for certain installed fittings are distinguished by separate symbols and calculated as a multiplier of the absorption distance B_N .

Absorption Distance	
B_N	for normal obstructions such as sensors, ventilators, outlets
$B_C = (1.5...2) \times B_N$	for fine filters, heat registers
$B_S = (2.5...3) \times B_N$	for particle filters
$B_d = (3...5) \times B_N$	for humidity sensors, duct humidistats

The absorption distance has no fixed value, but depends on many factors. These are depicted in the absorption distance nomogram below.

5.3.1 Determining the Absorption Distance

To determine the absorption distance, the following parameters are required:

- Air humidity before humidification x_1 in g/kg
- Air temperature after humidification t_2 in °C (with steam humidifiers the change in air temperature due to humidification may be disregarded t_1 or t_2)
- Specific increase in humidity Δx in g/kg (can be determined in the h,x diagram)

- quantity of steam introduced $\overset{o}{m}_D$ in kg/h.
- air speed w_L in m/s in air duct
- Total length l_D of the steam manifold installed in the air duct

Length l_D of the usable steam manifold depends on the dimensions of the air duct. The length of the absorption distance can be reduced by using multiple steam manifolds (also see section on the steam manifold).

Method:

Graphically determine absorption distance B_N using the absorption distance nomogram (also see Section „Absorption Distance Nomogramm“). Enter the value of the parameters enumerated above into the respective quadrants. The resulting point of intersection indicates the value of the desired absorption distance B_N .

Notes:

- Air humidity before humidification x_1 :.....[g/kg]
- Air temperature after humidification t_2 :.....[°C]
- Specific increase in humidity Δx :.....[g/kg]
- Quantity of steam introduced $\overset{o}{m}_D$:.....[kg/h]
- Air speed w_L :.....[m/s]
- Total length of steam manifold l_D :.....[mm]

5.3.2 Absorption Distance Nomogram

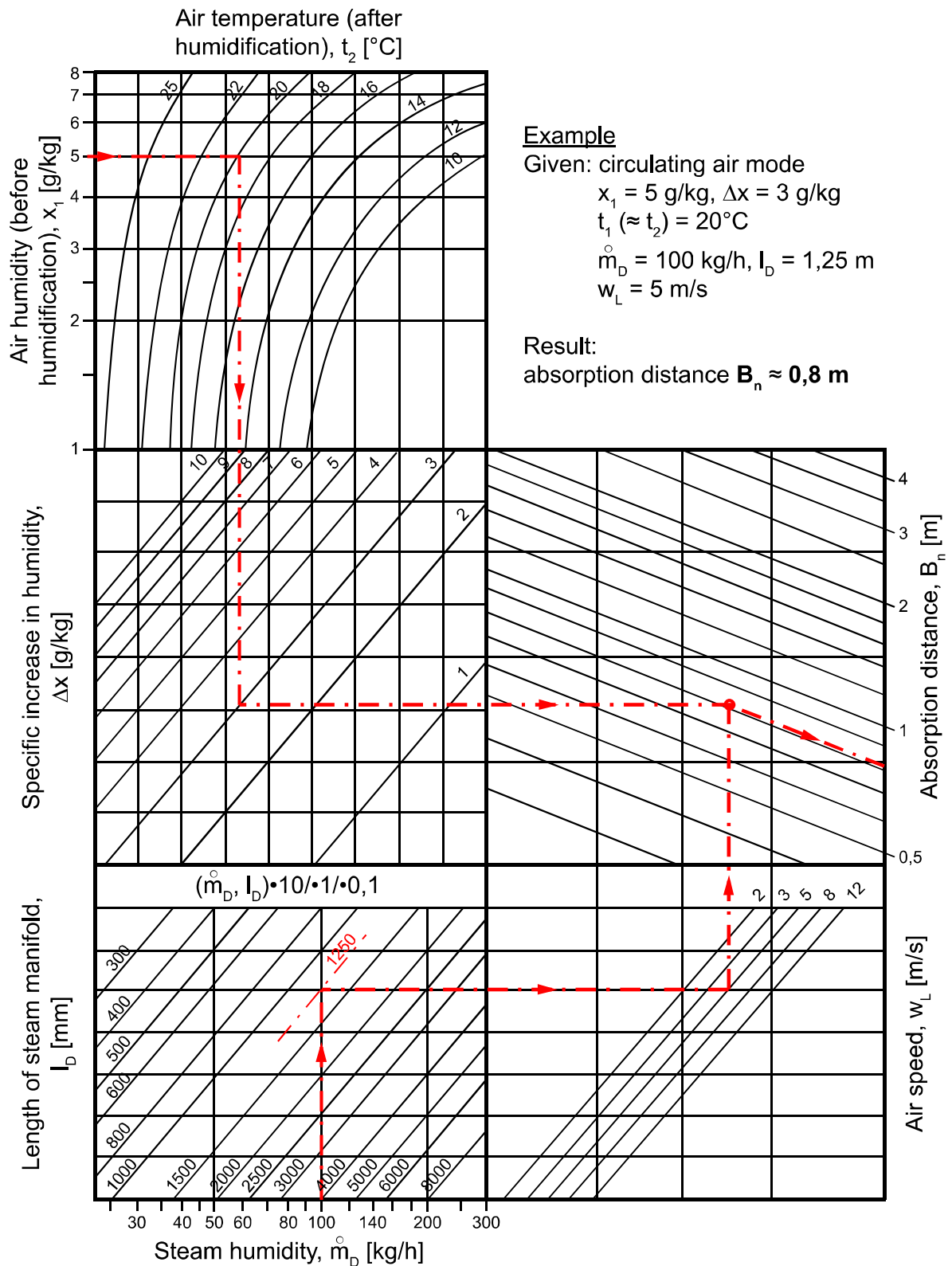

Source: Henne, Erich: Luftbefeuchtung (Air Humidification), 3rd Edition 1984 (Page 101), Oldenbourg Industrieverlag, Munich

5.4 Steam Manifold

5.4.1 General installation guidelines

When installing steam manifolds, pls. follow these guidelines:

Positioning within duct

- Install the steam manifold as close as possible to the steam humidifier in order to minimize steam loss through condensation
- Steam manifold placement on the supply side of the air duct is preferable
- Install steam manifold strictly horizontal in order to ensure proper condensate drain
- Shown installation and positioning dimensions are based on empiric values. Special environmental conditions may require adjustments. Pay special attention to avoid condensate generation in air duct

Allowable pressures

- Max. allowable pressure in air duct is 1500 Pa/.218 PSI (exemption: SLE02 only allows for 1200 Pa/.174 PSI)
- On suction side, max. -500 Pa (.07 PSI) is tolerable
- With high-pressure air conditioning systems, modifications of the unit's drain hose system may possibly be required depending on the overall pressure situation. These modifications must be **coordinated with your expert dealer.**

Water drain

- We point out that according to the German Association of engineers (VDI) guideline VDI 6022, a water drain must be provided within the absorption distance inside the air duct

When increased airflow speed is encountered

- Air flow rates beyond 3m/s (9.84 ft/s) may lead to condensate drainage problems at the steam manifolds due to vacuum built-up. A possible remedy is twisting the steam manifold in its horizontal axis by few angular degrees. In case of problems, pls. consult your expert dealer.

5.4.2 Recommendations for dimensioning

The recommendations given below are based on homogenous air flow in the duct.

Horizontal installation of steam manifold

Standard steam manifold arrangement:

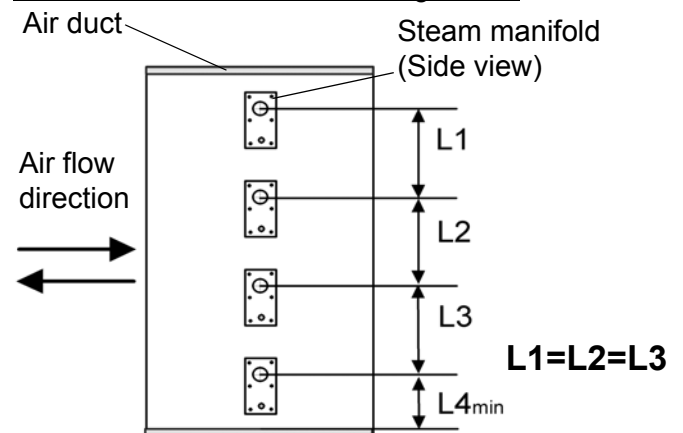

An even distribution of steam manifolds ensures a uniform steam distribution.

Please use the total height of the duct!

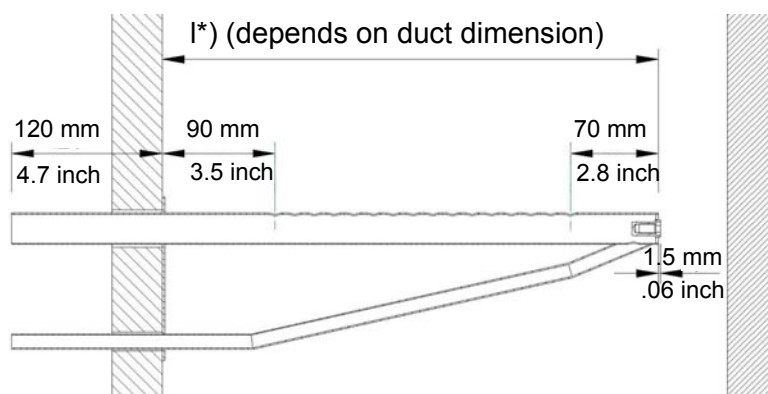

*) s. table of manifold lengths **Horizontal assembly position in duct**

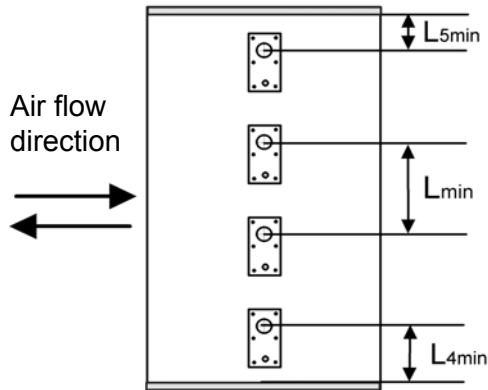

Minimum distance for condensation avoidance:

$L_{min} = 210mm/8.3\text{ inch}$: „Steam manifold - Next steam manifold“ distance

$L_{4min} = 120mm/4.7\text{ inch}$: „Lowest steam manifold - Duct bottom plane“ distance

$L_{5min} = 120mm/4.7\text{ inch}$: „Highest steam manifold - Duct ceiling plane“ distance

Steam manifold arrangement for special air duct shapings

flat	steam manifold laterally staggered (with respect to air flow direction) in case of L_{min} (s. above) not to be met	<p>Air flow direction</p>																
very flat	<p>by tilting the steam manifold 30 - 45° towards the air flow direction, the minimum upper clearance can be reduced to 70 mm/2.8 inch.</p> <table border="1" data-bbox="376 1429 906 1624"> <thead> <tr> <th>Min[mm/inch]</th> <th colspan="2">H1</th> <th>H2</th> </tr> <tr> <td></td> <th>30°</th> <th>45°</th> <td></td> </tr> </thead> <tbody> <tr> <td>DN25/1"</td> <td>182/7.2</td> <td>168/6.6</td> <td>225/8.6</td> </tr> <tr> <td>DN40/1 1/2"</td> <td>193/7.6</td> <td>179/7.2</td> <td>230/9.1</td> </tr> </tbody> </table>	Min[mm/inch]	H1		H2		30°	45°		DN25/1"	182/7.2	168/6.6	225/8.6	DN40/1 1/2"	193/7.6	179/7.2	230/9.1	<p>narrow channel</p> <p>Air flow direction</p>
Min[mm/inch]	H1		H2															
	30°	45°																
DN25/1"	182/7.2	168/6.6	225/8.6															
DN40/1 1/2"	193/7.6	179/7.2	230/9.1															
narrow, high	identical lengths one on top of the other, staggered laterally if possible																	
square	identical lengths, staggered vertically and laterally																	
low, very wide	facing each other																	

Vertical steam manifold installation

Steam manifold arrangement

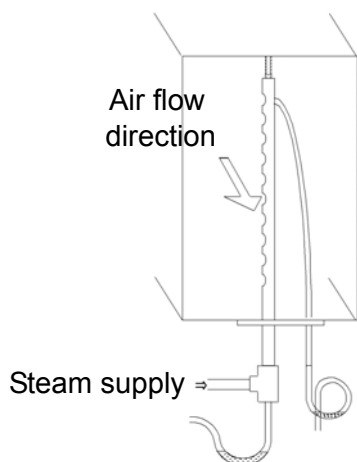

Horizontal installation of the steam manifolds is preferable. However, vertical installation into the air duct from below is also possible.

Standard manifold dimensions [mm]/ [inch]:**

I	220/ 8.7	400/ 15.7	600/ 23.6	900/ 35.4	1200 /47.2	1450 /57.1
DN25/1"	X	X	X	X	X	X
DN40/ 1 1/2"	X	X	X	X	X	X

*** Special lengths on demand.

Number and size of the steam manifolds available as well as the nominal diameter of the respective steam and condensate hoses may be taken from the tables shown in chapter „Technical Data“.

5.5 Steam line and condensate hose layout

Please note

Because of the high requirements on hose material under the operating conditions given, it is recommended to use genuine HygroMatik hoses only.

5.5.1 Guide lines for steam line design

- Steam hose nominal diameter must not be smaller than the steam outlet of the HygroMatik steam humidifier (do not restrict the cross-section, otherwise back pressure will increase)
- Steam hoses must be laid without sags and kinks and with a continuous slope of 5-10% (otherwise sags may result).
- Steam hoses must be supported every 500 mm (20 inches) by clamp brackets
- Steam hoses should be kept as short as possible. Implement lengths beyond 5 m (16 ft.) as insulated fixed piping to keep energy loss and condensate generation to a minimum. Beyond 10 m (32 ft.) insulated installation is a must. Fixed piping is generally recommended for straight steam line segments
- When 2 steam manifolds are in use (other than with a standard implementation), place steam Y piece as close as possible to the steam manifolds. Such, for the main part of the piping just one steam hose is required and condensate loss is minimized
- Allow easy access to the steam pipe/ steam hose installation
- Pressure conditions within the duct are influenced by device steam output, steam line layout and the duct composition itself. In some rare situations it may become necessary to optimize steam line layout for achieving the results intended
- Respect minimum bending radii:

DN 25 Steam hose: Rmin = 200 mm/8"
 DN 40 Steam hose: Rmin = 400 mm/16"

5.5.2 Condensate hose layout

The condensate hose may be run from the steam manifold back to the steam cylinder, as depicted in the schematic drawing below with concern to installation type 1. Alternatively, the condensate hose may be fed directly in a wastewater pipe or a drain (s. installation type 2).

Please note

Should condensate return into the steam cylinder be intended, the connection stub on the cylinder upper part must be drilled out first with a ANSI drill size „O“ drill. To do so, the steam cylinder must be removed from the housing (s. maintenance chapter, section „Steam cylinder removal and reinstallation“).

Drill out condensate hose connection stub with an 8 mm (ANSI drill size „O“) drill, if required

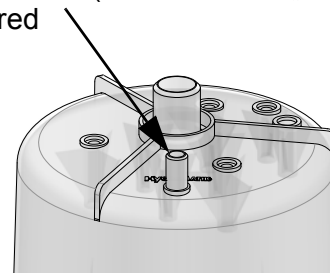

Steam cylinder top view

5.5.3 Steam line and condensate hose installation types

Installation type 1

Steam manifold is positioned more than 500 mm above device upper edge:

- » Run steam hose to a height of 400 mm/16 inch minimum above the steam humidifier and then to the steam manifold with a continuous incline of 5 to 10 %.
- » Feed condensate hose from steam manifold with a decline into waste-water pipe or drain.
- » As a steam barrier, lay out a 200 mm/8 inch min. loop (s. schematic representation below). Minimum distance from steam manifold to loop must be 500 mm/20 inch. Fill loop with water prior to steam humidifier commissioning.

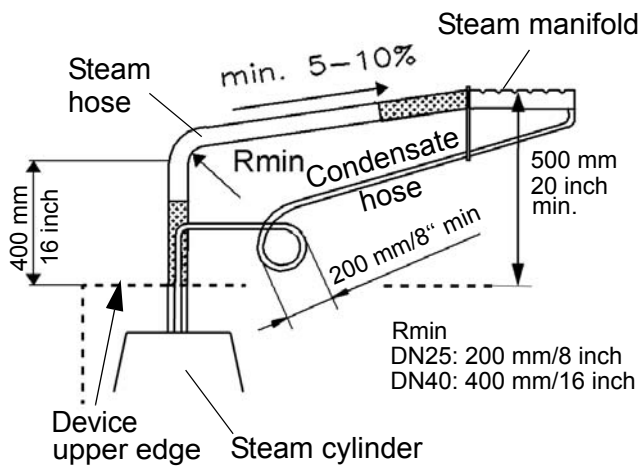

**Installation type 1,
schematic representation**

Installation type 2

Steam manifold is positioned less than 500 mm above or below device upper edge:

Please note

In this arrangement the condensate hose cannot be fed back to the steam humidifier.

- » Run steam hose to a height of 400 mm/16 mm minimum above the steam humidifier and then to the steam manifold with a continuous decline of 5 to 10 %.
- » Feed condensate hose to a waste-water pipe/drain with a 200 mm/8 inch diameter loop as a steam barrier. Minimum distance from steam manifold to loop must be 500 mm/20 inch. Fill loop with water.

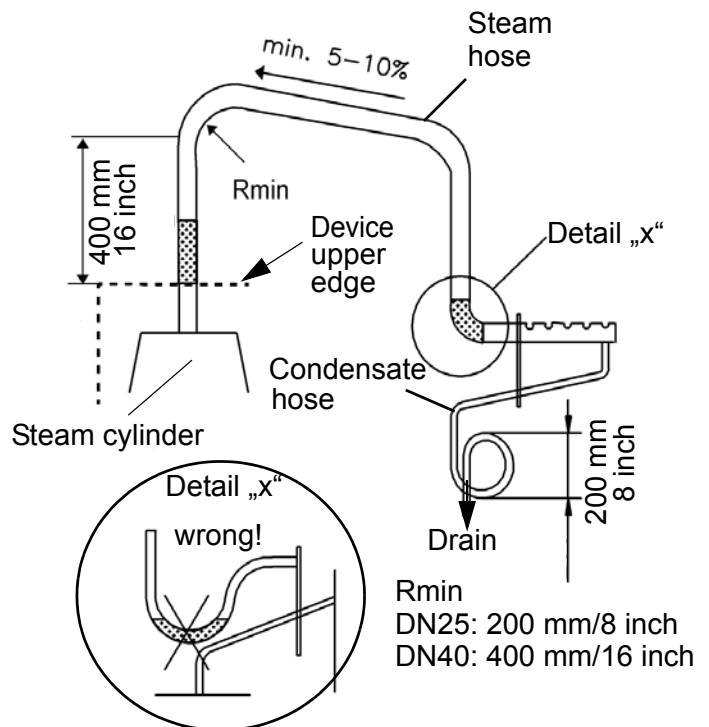

**Installation type 2,
schematic representation**

6. Water connection

▲WARNING

Risk of scalding!

Very hot water to be found in and around the steam humidifier during and after operation.

Have all installation work done by expert staff in order to avoid scalding hazards due to improper water guidance.

▲WARNING

Risk of electrical shock!

Hazardous electrical high voltage!
Before starting installation work ensure that the unit is not yet connected to the power supply.

General Rules

- Obey local water utility regulations
- Verify that necessary safety measures have been taken – in compliance with either German Technical and Scientific Association for Gas and Water (DVGW) guidelines (DIN EN1717) or local regulations – to eliminate backflow of polluted water into drinking water treatment facilities. This may require the installation of a system separator and free discharge into the drainage system. Within the humidifier, a double check valve (58) is located in the water supply line. It prevents - in accordance with DIN EN 61770 - the backflow of water. As an option for installation by the customer, the DVGW-conform **HyFlow** system separator or a after market system separator of the BA/CA type are available from HygroMatik.
- Use feed water without chemical additives and with a conductivity between 200 and 800 $\mu\text{S}/\text{cm}$ only. Beyond conductivity levels of 800 $\mu\text{S}/\text{cm}$ up to a maximum of 1250 $\mu\text{S}/\text{cm}$ and below conductivity levels of 200 $\mu\text{S}/\text{cm}$ to a minimum of 125 $\mu\text{S}/\text{cm}$, special adjustments are required. In this case please contact your specialist dealer

- Supply water must not exceed 40 °C (104 °F)
- Allowable range of water pressure: 100000 to 1000000 Pa (14.5 to 145 psi)
- For connection to the water supply pipe, make use of a water hose
- Blow-down water must drain freely

6.1 Operation with softened water

NOTICE

Do not use softened water unless special measures are taken!

When feeding softened water into the Hygro-matik steam humidifier, the aspects outlined below must be taken into account.

Softened water may cause

- unacceptably high conductivity
- the formation of salt bridges between the electrodes and the electrode leads on the inner surface of the steam cylinder upper part
- foaming in the steam cylinder

Salt bridges may cause electrical arcs. These are indicated by the presence of black grooves in the top part of the cylinder. The cylinder must then be replaced to prevent further damage to the cylinder material, as well as short circuits which may trip main circuit breaker.

Foam may come into contact with the maximum level sensor electrode and trigger the max. level status message despite the cylinder not being full yet and the nominal current not yet established.

With softened water, at operating temperature conductivity level usually is higher than is the case with tap water.

If using a water softening system, we recommend diluting the softened water with normal tap water to produce an overall **hardness between 4-8°gH**. This value can be set lower if the water does not foam.

6.2 Water supply

NOTICE

Foreign material in water supply pipe may cause premature wear of the solenoid valve.

Flush the water supply pipe before making connection to the solenoid valve. This is of particular importance in case of a newly installed pipe.

- » Install a shut-off valve (AV) in the supply line.
- » Install a water filter (WF) if required due to bad water quality.

Please note

In case of no safety device for drinking water protection according to DIN EN 1717 present in the house installation system, a system separator at least of the CA type or use of the Hyflow retrofit option is mandatory.

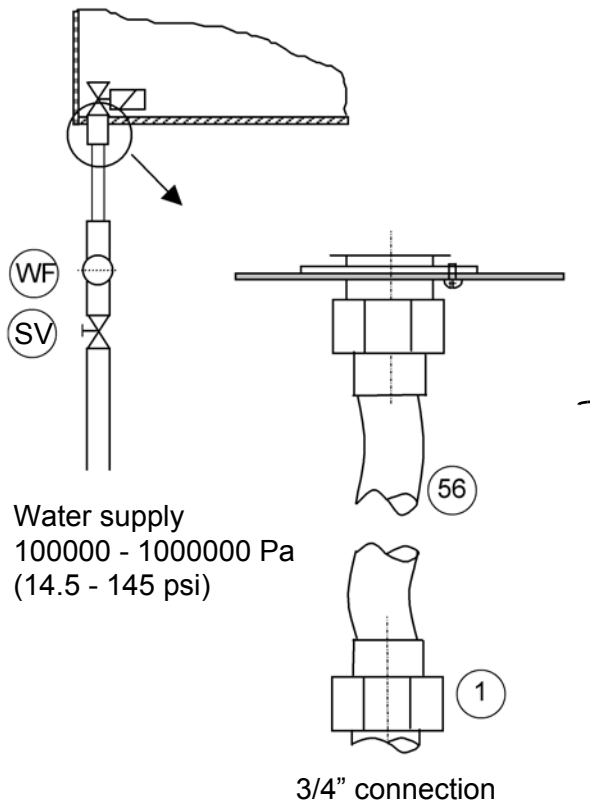

Please note

Shut-off valve (SV) and water filter (WF) are not included in the delivery.

For connection to the water supply line, the water hose (56) with cap nuts on both ends supplied with the unit may be used.

Make connection as follows:

- » Attach cap nut with inner seal ring to inlet screw joint on the humidifier housing and tighten.

NOTICE

Do not overtighten the cap nut!

Excessive tightening will destroy the fitting.

Please note

Strainer must be placed inside the solenoid valve.

- » Screw the other hose end cap nut with its inner seal on a customer-provided water tap (cap nut internal thread is 3/4").

6.3 Water discharge

▲WARNING

Risk of scalding!

During blow down up to 0.3 l/sec (.08 gal./sec) are being drained with a temperature of about 95 °C (203 °F).

Ensure that the drain hose is reliably fastened and wastewater can drain freely and pressureless.

Please note

Humidifier installation location and wastewater discharge must be on the same pressure level.

Guidelines for water discharge composition

- Use flexible water hose
- Do not buckle drain hose
- Discharge line and drain pipe material must be temperature resistant up to 95°C (203 °F)

How to proceed

- » Run a 1 1/4 " drain hose of 250 to 1000 mm (10 to 40 inch) length into a pressure-free outlet according to DIN EN 1717. The hose must be guided sideways of the humidifier to prevent ascending vapor from condensing on the humidifier's housing.
- » Fit drain hose to connection stub on humidifier housing bottom side.

Grounding clip functioning

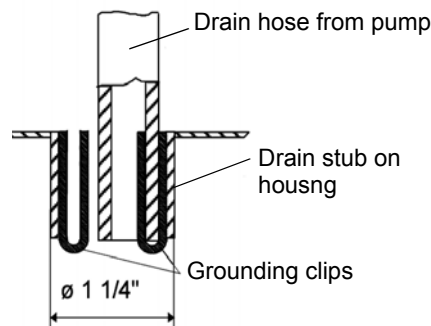

The two grounding clips attached to the inner surface of the housing drain stub are in direct contact with water and shunt potential residual electric currents away from the housing during blow-down and in case of a cylinder water overflow.

Between the pump drain hose jacket and the inner surface of the cabinet drain connection, a gap exists due to the diverging diameters. If water collects on the base plate, it will flow through this gap into the drain hose and then into the drainage system.

Please note

With the optional wastewater cooling system **HyCool**, HygroMatik offers an option for limiting the steam humidifier wastewater temperature in order to protect thermosensitive wastewater pipe lines. By blending with tap water during blow-down and rinse processes, wastewater temperature is below 60 °C (140 °F) as long as inlet water temperature does not exceed 30 °C (86 °F).

6.4 Water connections final check

Go down the following water installation checklist:

- All screws and clamps properly tightened?
- Water supply line flushed before making connections?
- Water connection properly installed?
- Water discharge properly installed?
- Does blow-down water drain freely?
- Water supply line and water discharge leakage-free?

7. Electrical connection

⚠ WARNING

Danger of electrical shock!

Dangerous electrical voltage!
All work relating to the electrical installation may only be carried out by designated specialist personnel (electrician or qualified person with equivalent training).

Please note

The customer is responsible for monitoring the qualifications of the specialist personnel.

Do not connect the steam humidifier to the live power supply before all installation work has been completed.

General installation rules

- All local rules concerning the implementation of electrical installations must be obeyed
- Electric connector cables to be laid professionally
- Install the electrical connections according to the wiring diagram
- With units of a nominal power output > 33 kW electrical connection to a permanent line is mandatory (according to VDE 0700 Part 98, IEC 60335-2-98)

NOTICE

Possible electronic components destruction through electrostatical discharge!

Prior to commencing electrical installation work, steps must be taken to guard the sensitive electronic components of the unit control against damage from electrostatical discharge.

7.1 Electrical installation approach

- » Provide fuses with a contact gap of at least 3mm per pole.
- » Install a separate main connection for each steam cylinder including main circuit breaker, main switch etc. .
- » Make main connection according to the table below.

Main connection

For the StandardLine steam humidifiers, main connection is to be implemented as follows:

Model	Main connection
SLE02	220-240 VAC/1~/ 50-60Hz
SLE05 SLE10 SLE15 SLE20 SLE30 SLE45 SLE65	380-415 VAC/3~/ 50-60 Hz

Other operating voltages on request.

Fusing

Please note

HygroMatik recommends the use of slow blowing up to middle time-lag main fuses (only applies to the a.m. mains supply voltage).

Steam humidifier installations should incorporate an individual resilient current circuit breaker.

Maximum current draw of the StandardLine standard models and the required fusing resulting from that can be taken from the table below.

Model	Current draw [A]	Fusing [A]
SLE02	6.5	1x10
SLE05	5.4	3x6
SLE10	10.8	3x16
SLE15	16.3	3x20
SLE20	21.7	3x25
SLE30	32.5	3x35
SLE45	48.8	3x63
SLE65	70.4	3x80

7.2 Cable connections

The table below shows the number and dimensioning of the cable connections provided by the various StandardLine housing types.

Housing type	M16	M25	M25 with MSI*)	M32	M40
SLE02	1x		1x		
SLE05/10		1x	1x		
SLE15/ 20/30		1x		1x	
SLE45/65		1x			1x

*) Multiple seal insert

Characteristics of metric cable connections

Thread	Wrench size [mm]	Cable diameter supported [mm]
M16X1.5	20	4.5 - 10
M25x1.5	30	9 - 17
M25x1.5 with MSI*)	30	6 (3x)
M32x1.5	36	13 - 21
M40x1.5	46	16 - 28

*) Multiple seal insert

7.3 Safety interlock

⚠ WARNING

Risk of electrical shock!

Hazardous electrical voltage!
When standard wiring was made, terminal 1 shows 230 VAC after commissioning.

Across terminal 1 and 2 the so-called safety interlock is wired. This wiring allows for integration of safety devices. In case of an open safety interlock the steam humidifier does not operate.

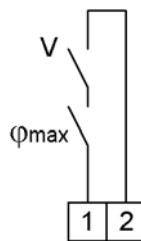

Safety interlock terminals 1/2 on main PCB

Please note

Factory setting leaves the safety interlock open!

Install contact interlocks, e.g. a max. hygrosat, vane relays, pressure controllers, air interlock devices etc. in series across terminal 1 and 2.

NOTICE

Contacts across terminals 1 and 2 must be potential free and properly rated!

Rating must comply with the control voltage in use.

Best practice implies the integration of a max. hygrosat in the safety interlock wiring to protect against over-humidification due to a r.h. sensor malfunction.

7.4 Control signal

As described in the „Unit Control“ chapter, section „Provider level submenu and its parameters“, the unit control type is determined by parameter „1-2“, „control signal“. In accordance with the control type selected, terminal wiring of the connection terminal (s. „Unit control“ chapter, section „Main PCB connections“ is to be made.

7.4.1 1-step operation

Steam humidifier operation is controlled by the contact across terminals 3 and 5 provided by the customer. This contact needs only to be low voltage proof.

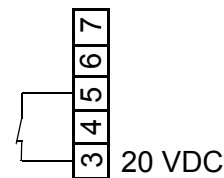

Customer-provided contact for 1-step operation

7.4.2 Operation with an active humidity sensor or external controller

When driving the steam humidifier by an active r.h. sensor or external controller (e.g. a PLC), control signals in the range of 0...10 V, 0...20 mA or 0...140 Ohm may be applied. Each one of the signal types is connected to a dedicated terminal (see „Unit control“ chapter, section „Main PCB connections“). Reference is always to terminal 4, GND.

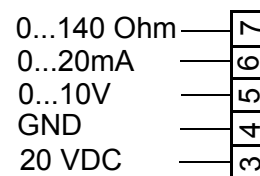

Terminals for control signals

Please note

Active r.h. sensors need an external supply voltage. For that purpose, terminal 3 has a +20 VDC offering.

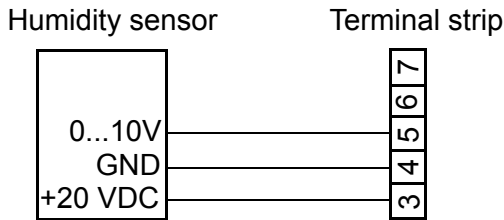

Exemplary 0...10V humidity sensor connection

7.4.3 Wiring for control signal and safety (interlock) system for multiple units

In the case of multiple units, separate humidifiers work together. The control signal and the safety (interlock) system are connected to the master unit as described above. In addition, connecting cables are established between the guiding unit and the succeeding unit(s) (provided on-site). These provide the succeeding unit with a control signal from the guiding unit and the transmitted (potential free) safety (interlock) system.

The wiring for the control signal and the safety (interlock) system must be implemented as follows for multiple units:

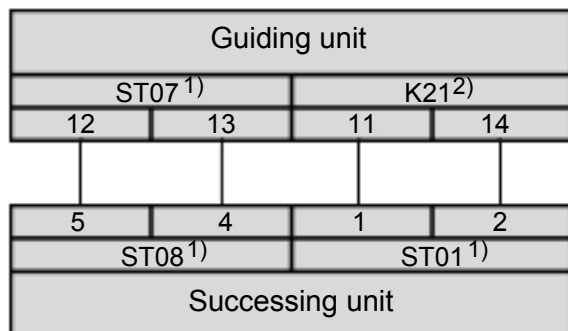

¹⁾ „ST0x“ designates connector plugs on the mainboard

²⁾ „K21“ is the relay used for the connection of the succeeding unit

7.5 Connection diagram

Pls. find the full wiring diagram in the „Unit control“ chapter, section „Main PCB connections“ of this manual.

7.6 Electrical installation check list

Check electrical installation with respect to customer-site requirements and local power supply regulations.

- Safety interlock properly wired across terminals 1 and 2?
- Supply voltage in accordance with name plate voltage rating?
- All electrical connections made according to the wiring diagram?
- R.h. sensor properly connected with respect to signal type and supply voltage (only when r.h. sensor is in use)?
- All screw terminal connections properly tightened?
- Have all electrical cable and plug connections been properly tightened?
- Proper unit grounding made?

8. Commissioning

▲WARNING

Risk of operating error!

Start-up of the unit is restricted to expert staff only (electricians or expert personnel with equivalent training).

Step 1: Check of mechanical integrity and wiring

- » Open housing cover.
- » Check cylinder seating.
- » Check steam, condensate and drainhose clamps.
- » Check that all electrical wire connections (including steam cylinder wiring) are tight and secure.

Step 2: Switching on the steam humidifier

- » Switch on main breaker.
- » Open water supply stopcock (operating pressure should be 1bar min., 10bar max.).
- » Switch on unit by setting control switch to "I".

Step 3: The unit performs a self-test and, then, commences normal operation

- During self-test, the On/Off button icon  flashes for a couple of seconds
- On completion of the test, the software version is displayed for a short moment. Consequently, normal operation is commenced. However, steam is not produced without a demand pending

Step 4: Trigger steam demand

- » Set control to 1-step operation, i.e. permanent steam demand, and close safety interlock.

Please note

Steam production may show a delay of up to 20 mins.

- » Allow all electrical functions to terminate in their programmed order.

Step 5: Monitor unit function and check for leakage

- » Let unit operate for 15 to 30 minutes.
- » If leaks appear, switch off the unit.

▲WARNING

Risk of electrical shock!

Hazardous electrical voltage!
Follow safety instructions for work on live components.

Step 6: Repair leaks

- » Find leaks and eliminate.
- » Check again for leaks.
- » When everything is o.k., reattach housing cover.

Additional checks:

- All electrical functions must be executable

9. Maintenance

9.1 General

For the achievement of a long unit life span, regular maintenance is a must. Maintenance works to be performed refer to unit assemblies that underlie either mechanical or electrical wear and tear, or may be impeded by residues in their proper functioning.

The steam humidifier's performance and maintenance intervals primarily depend on the water quality encountered and the amount of steam produced. A particular water quality may shorten or lengthen maintenance intervals. The amount of residues found in the steam cylinder allows for a hint on future maintenance intervals.

Another scenario influencing the unrestricted unit availability refers to the main contactor that has a maximum number of switch cycles as indicated by its manufacturer. Unit control monitors the number of switch cycles and produces a maintenance message as soon as the max. number is reached.

Need for maintenance is indicated by illumination of the  service icon in the unit control panel display. Depending on the trigger, reading value „Status“ then shows a „271“ (Service Steam Amount) when a certain produced steam amount threshold preset was exceeded, or „272“ (Service Main Contactor).

In the latter case, the main contactor should be replaced and the counter be reset (s. parameter „3-2“).

In case of „Service Steam Amount“, maintenance work mainly encompasses checking and cleaning all of the unit parts including the steam cylinder inside, and a unit test run. Steam humidifier electrodes are prone to burn-off during steam production and must, consequently, be replaced in a regular time frame.

As part of the maintenance work, screw terminals and plug connections must be checked every time. If required, retightening the terminal screws is a must as well as ensuring tight fit of all of the plug connections.

Since steam and condensate hoses are subject to wear as well, hoses must also be checked regularly.

Seals are wear parts. As such, seal integrity checks and replacement, if required, is also a part of the regular maintenance work.

9.1.1 Safety instructions for maintenance

▲ WARNING

Risk of electrical shock!

Hazardous electrical voltage. Unit must be switched off and protected against restart by expert staff (electricians or expert personnel with equivalent training) before any maintenance work is commenced.

▲ WARNING

Risk of skin burning!

Hot steam cylinder during operation and for some time afterwards.
Drain steam cylinder before any maintenance work is commenced. After that, wait approx. 10 mins before starting maintenance work.
Check steam cylinder temperature by cautious approximation with hand (do not touch!).

▲ WARNING

Risk of scalding!

Water pumped or drained from the steam cylinder may have a temperature of up to 95 °C.
Wear proper PPE (Personal Protection Equipment)!

NOTICE

Take care of ESD protection!

The electronic components of the humidifier control are very sensitive to electrostatic discharges. In order to protect these components during maintenance, steps must be taken to guard against damage from electrostatic discharge.

9.2 Maintenance frame work

Mineral deposits precipitate and crystallize very differently in different types of water, even when two types have the same conductivity and hardness levels (the various constituents in the water interact differently).

Instructions on maintenance and cleaning intervals, or on electrode service life, are based entirely on empirical data.

In most cases, the conductivity levels given in the "Directions for Use" section of this manual may be considered as typical values. Individual parameter settings as part of the control software may be necessary.

Very seldomly, water pretreatment may be necessary (softening by dilution to approx. 4 - 8 °gH; decarbonization/partial desalination to achieve target reductions in carbonate hardness).

For any questions with regard to water treatment systems pls. contact your expert dealer.

Cycle time	Maintenance work
<p>4 weeks after commissioning (with normal water quality)</p>	<p>Visual inspection of electrical and mechanical connections</p> <p>Remove mineral deposits from steam cylinder, water drain hose and blow-down pump</p> <p>Check electrodes for burn-off</p> <p>Re-tighten electrode hand nuts and all screw terminals</p>
<p>semiannually (with normal water quality and "normal" operation, i.e. 8 hours per day)</p>	<p>Visual inspection of electrical and mechanical connections</p> <p>Remove mineral deposits from steam cylinder, water drain hose and blow-down pump.</p> <p>Check electrodes for burn-off and replace, if required. Re-tighten electrode hand nuts and all screw terminals</p>

9.3 Removal and reinstallation of the steam cylinder

⚠ CAUTION

Risk of eye injuries!

The clips that fix the steam cylinder halves have sharp edges and can jump off during dismantling.

Eye injuries are possible.

Wear proper PPE (Personal Protection Equipment)!

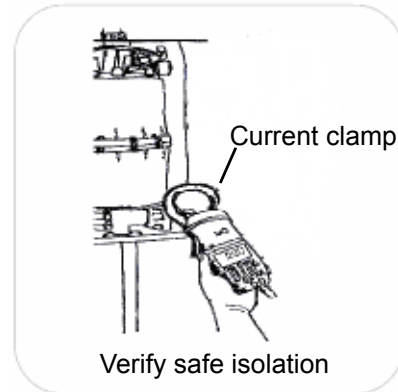

Steam cylinder removal

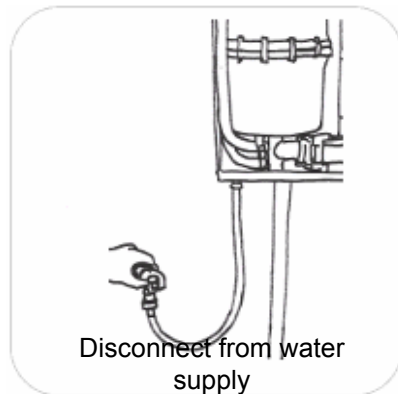
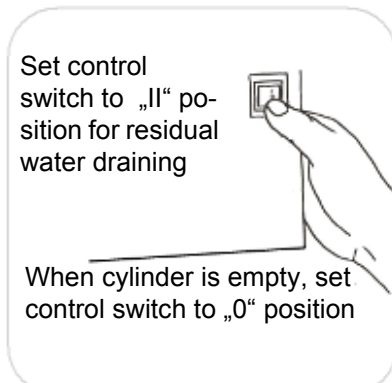

» Remove unit housing cover

- » Remove Super Flush solenoid hose from cylinder bottom (if applicable).
- » Remove steam hose from steam hose adapter.

If the steam hose is not to be disconnected, the steam hose adapter with the steam hose still attached may be detached from the steamcylinder as shown in the next figure.

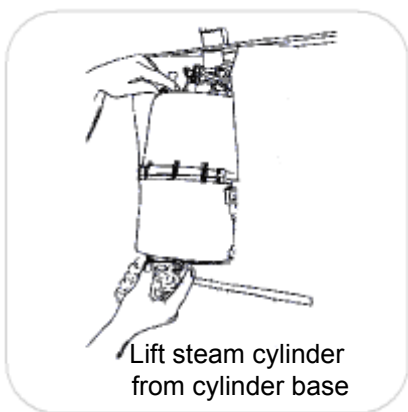
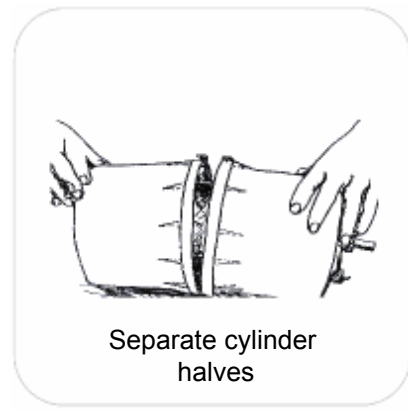
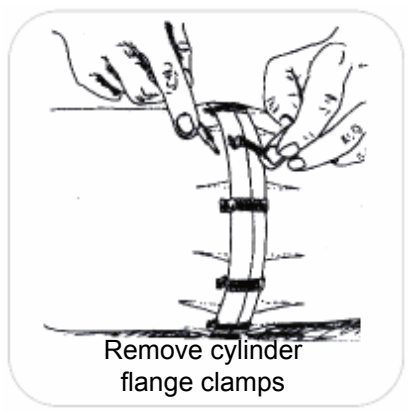
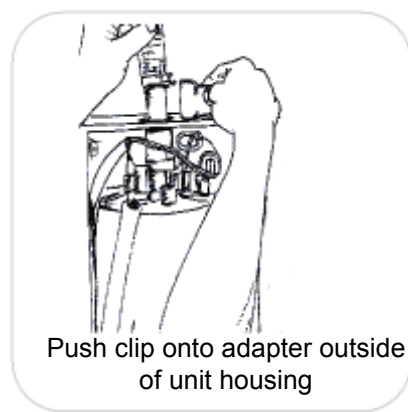
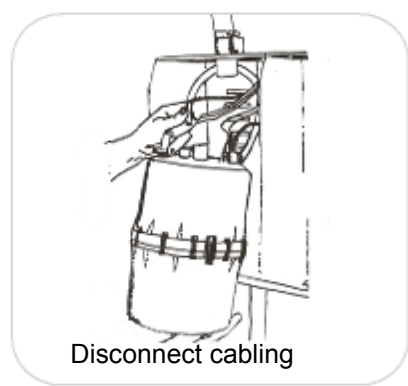
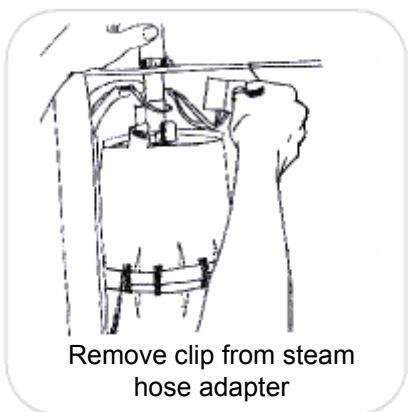

Reinstallation

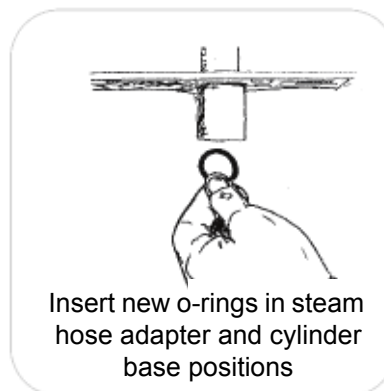

Please note

When re-assembling the cylinder, brackets and reinforcement joints of the two cylinder parts must be aligned.

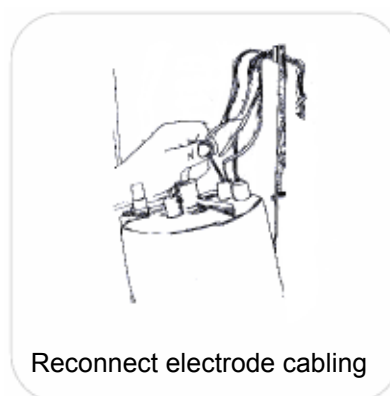
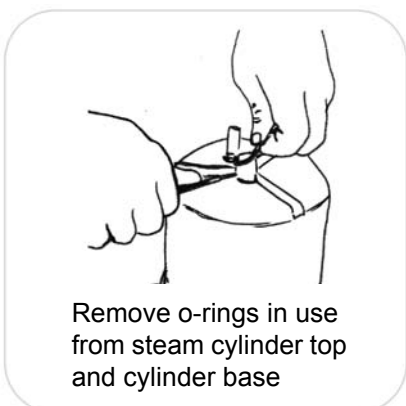
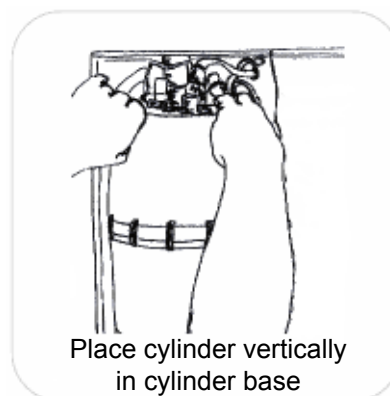

Please note

The electrode connections must not show any signs of corrosion. Replace plugs, if required. Plugs must sit firmly on the electrode pins and must be pushed down as far as they will go.

- » Reattach Super Flush solenoid hose (if applicable) to steam cylinder bottom stub.

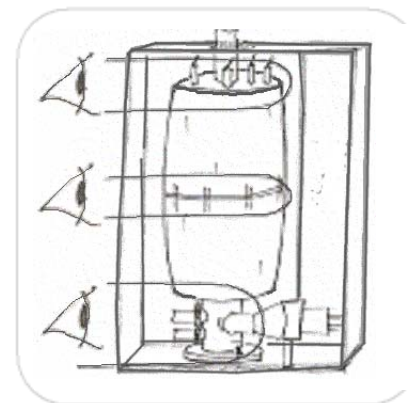
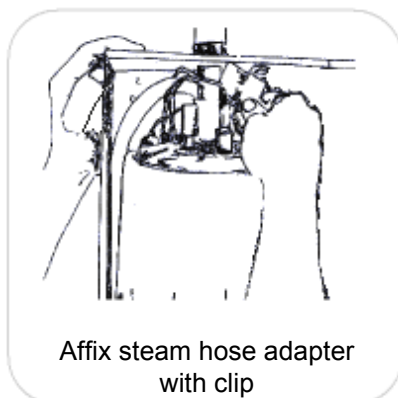
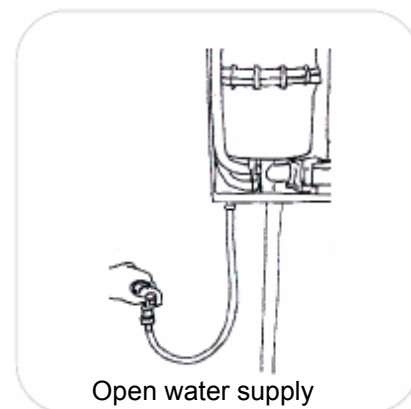
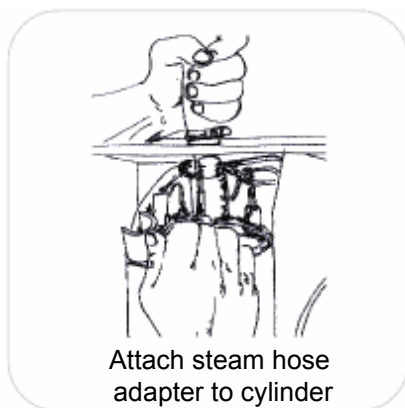
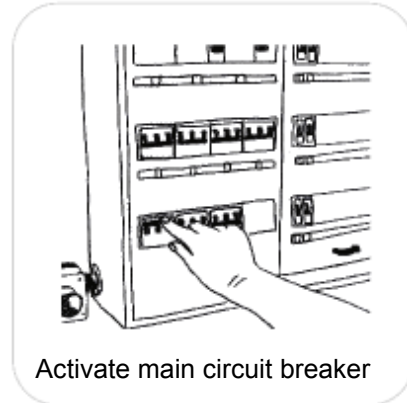

- » Reattach unit housing cover

9.4 Steam cylinder, electrodes and cylinder base cleaning

For cleaning, mechanical removal of the deposits is usually sufficient.

NOTICE

Risk of functional disruption!

When using acids or other chemicals for cleaning, thoroughly flushing and rinsing is essential otherwise cylinder water conductivity may be impaired.

Steam cylinder cleaning



- » Check the inside of the top part of steam cylinder for crust build-up and possible salt bridges (black grooves between the electrode leads). If present, wash away/scrape off completely.

Please note

If electrical arcs have burned deep grooves into the material, the complete cylinder must be replaced.

Electrode cleaning

- » Clean the sensor electrode until metallically bright.
- » Clean electrodes and check electrode wear (s. „Changing electrodes“ section).

Cylinder base cleaning

- » Just as the cylinder, the cylinder base and its connection joints must be checked for deposits and be cleaned, if required.

Reinstallation of the steam cylinder is to be performed as described in the „Cylinder removal and reinstallation“ section.

9.5 Checking cable connections

NOTICE

Risk of functional disruption!

Risk of material damage!

Loose cable connections may result in increased transition resistance and contact area overheating.

- » Check all cabling screw terminals and plugs for tight seating. Plugs must sit on their respective contacts as far as they will go.

9.6 Solenoid valve removal/reinstallation and fine filter cleaning

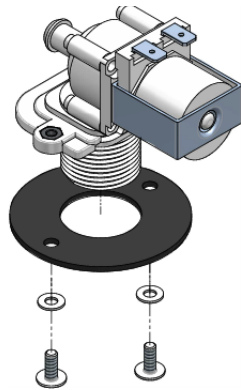

Solenoid valve

Removal

- » Shut off water supply and disconnect tap water hose cap screw connection.
- » Remove connecting hose (20) from cylinder base.
- » Detach electrical cable connector from solenoid valve (25).
- » Unscrew solenoid valve mounting screws.
- » Remove solenoid valve from housing bore.

Fine filter cleaning

- » Remove fine filter from solenoid valve tap water connection side and clean under running water.

Reinstallation

- » Reinsert fine filter into solenoid valve.
- » Reinsert solenoid valve with seal in unit housing bore.
- » Bolt-down solenoid valve.
- » Reestablish tap water connection.
- » Reconnect electrical cable to solenoid valve.

- » Reattach connecting hose (20) to cylinder base using clamp.
- » Turn on water tap.
- » Switch on unit and check for leakages after 15 to 30 mins of operation.

⚠ WARNING

Risk of electrical shock!

Hazardous electrical voltage!

Follow safety instruction for work on live components.

Leakages may invoke leak currents.

- » In case of leakage turn off power supply and secure against being switched on again.
- » Find leakage and eliminate.
- » Check again.

9.7 Cleaning of blow-down pump

Removal and cleaning

- » Remove steam cylinder as described in „Removal and reinstallation of steam cylinder“ section.
- » Detach adapter (30) from pump (32).
- » Detach electrical cable from pump.
- » Unscrew mounting screws from housing bottom plate (safe vibration buffer, bolts and washers for reinstallation) and pull pump out of cylinder base (37).
- » Open pump bayonet lock.
- » Remove residues from pump and drain hoses (replace O-ring if required).

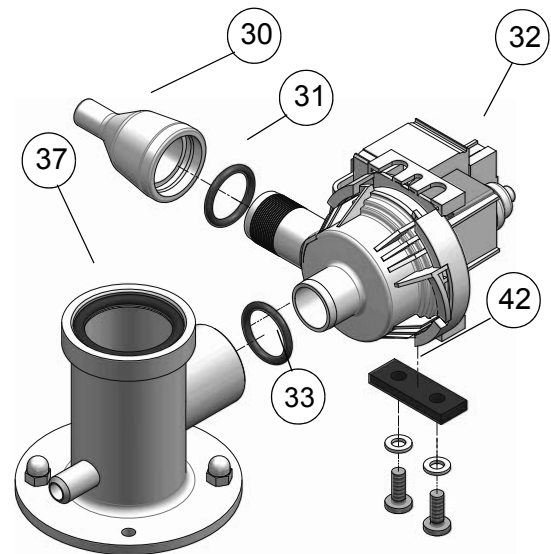

Blow-down pump

Reinstallation

- » Moisten O-ring (33) and insert into cylinder base (37) horizontal stub.
- » Push pump back into cylinder base and bolt to bottom plate incorporating the vibration buffer and washers saved during removal.
- » Moisten O-ring (31) and insert into adapter.
- » Slide adapter (30) onto pump stub.
- » Refit electrical cable to pump connector (no polarisation).
- » Let unit run for 15 to 30 mins, then check for leakages.

⚠ WARNING

Risk of electrical shock!

Hazardous electrical voltage!
Follow safety instructions for work on live components.
Leakages may invoke leak currents.

- » In case of leakage turn off power supply and secure against being switched on again.
- » Find leakage and eliminate.
- » Check again.

9.8 Inspection of hoses

Since steam and condensate hoses are prone to wear as well, those hoses should undergo regular checks as well.

9.9 Electrode replacement

» Remove and open cylinder, as described in section "Removal and reinstallation of the steam cylinder".

Please note

When mounting the electrodes, make sure that the hand nut colours corresponding with the wiring colours remain in the same position as before in order to omit any unwanted shift of electrical potential. Hence, the hand nut positions must be recorded before they are removed. During reassembly, particular care must be taken to ensure that no grey wire is connected to the electrode plug next to the (grey) sensor electrode hand nut.

» Unscrew hand nuts (49)

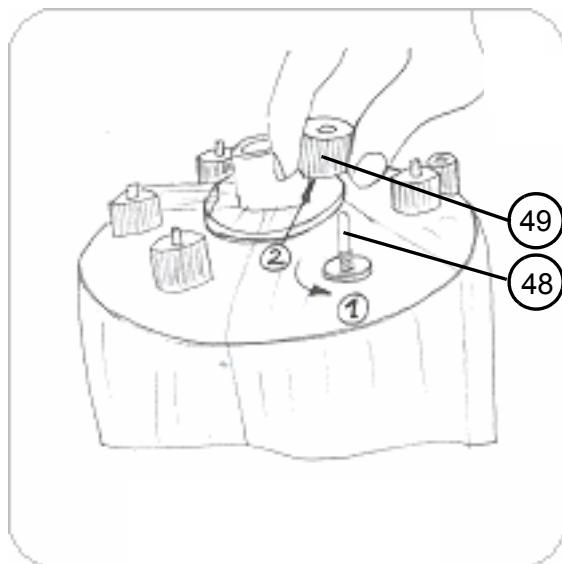

- » Remove electrodes (48)
- » Install new electrodes (48). Make sure that the electrodes are positioned correctly (see exploded view).

Please note

The electrodes for use with the CY45/2 steam cylinder feature a two-fold sealing (s. fig.) In order to allow for the problemfree electrode installation, moisten the upper o-ring with water or soap solution.

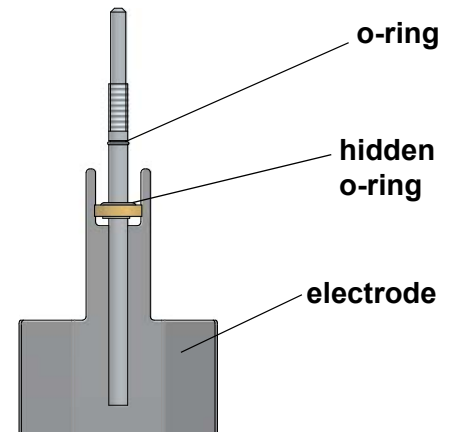

Two-fold sealing of the electrodes for the steam cylinder CY45/2 (SLE50/65)

- » Hand tighten the nuts (49).
- » Use solvent-free, HygroMatik-quality o-rings (for flange, electrodes, cylinder base and steam hose adapter).
- » Assemble steam cylinder
- » Plug the electrode plugs (4) directly onto the electrodes (48)
- » Install the steam cylinder

Genuine electrode length

Hygromatik large area electrodes made from stainless steel have the following genuine lengths:

Model	SLE05, SLE10	SLE20	SLE30	SLE45, SLE65
Length [mm]	155	210	235	310 ^{*)}

^{*)} The electrodes installed in the new CY45/2 steam cylinder feature a length of 300 mm

Electrode wear

Electrode wear depends on:

- composition and conductivity of the supply water
- the amount of steam produced

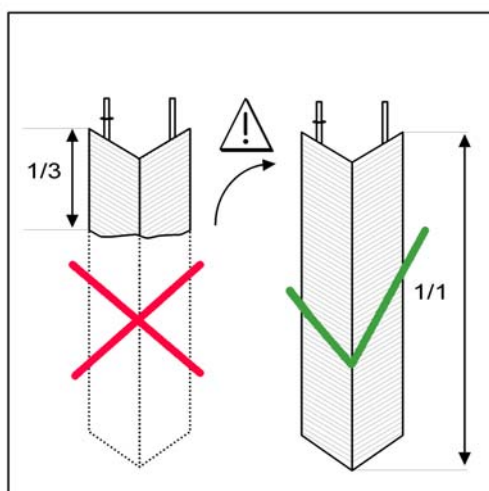

In case of the electrodes being burned-off to less than one third to half of their genuine length, electrode replacement should be made.

Please note

When cylinder water maximum level is detected for a period of 60 mins, an error message (s. unit control chapter) is generated and unit operation is cut. At the latest, electrode replacement should then be made.

9.10 Functional check

- » Run the system with maximum output for a couple of minutes
- » Check all safety devices.
- » Check hose connections and seals for leakage.

9.11 Finishing maintenance

After finishing substantial maintenance work, the service interval „Steam amount“ must be reset (s. sections 11.5.2 und 11.8).

To do so, follow the procedure below (use the „ \wedge / \vee “ keys for changing the values displayed):

- » from standard display, select „P00“.
- » confirm with SET key.
- » input code „010“.
- » confirm with SET key.
- » change display from „1--“ to „3 --“ (select parameter group „Service“).
- » confirm with SET key.
- „3-1“ is displayed
- » confirm with SET key.
- » change display from „0“ to „1“ („Reset service interval“).
- » Confirm with SET key.
- » return to standard display by touching the ESC key twice.

The steam amount counter now again holds the value preset (s. „3-3“ parameter, „Service interval [t]“), that determines the next time for maintenance when met.

10. Dismantling

Once the steam humidifier will no longer be used, dismantle (demolish or scrap) it by following the installation procedures in reverse order.

▲ WARNING

Warning: Dismantling of the unit may only be performed by qualified personnel. Electrical dismantling may only be performed by trained electricians.

Please note

Obey the safety guidelines in section “Safety Instructions,” especially the guidelines for disposal.

11. Unit Control

11.1 General description

Operation of the HygroMatik steam humidifier is under microprocessor control.

A control switch can be found on the device front panel featuring two positions besides the „Zero“-position for a switched-off device.

„Pos. I“ : The unit is switched on

„Pos. „II“ : Cylinder water is manually drained



Control switch

For controlling the unit a control panel featuring a 3-digit display and 10 icons plus 4 touch keys is integrated in the unit front panel. Controlling the unit by software using the modbus RTU protocol is also possible. On request, modbus documentation is available from your expert dealer.



Control panel

For control signal processing inputs are available whose properties may be defined by parameter setting. Activating of the intake solenoid valve, the blow-down pump and the main contactor is achieved through relays on

the main PCB. Another relay serves for signalling purposes (factory setting is „collective fault“).

As an ordering option, for provision of 2 additional switching functions, a pair of relays of the top-hat rail type is available for the plugable connection to the mainboard.

Electrode current is directly switched by one or two main contactors designed to fit the respective unit power.

Mainboard

The complete control logic including the relays for basic operation is realised on a compact PCB that is mounted on the vertical separating wall between the unit chambers. All connections on the PCB are distinctive in order to allow for easy exchange of the board in case of maintenance.

On the mainboard, two vertically mounted fuse holders with bayonet fitting incorporate 1.6 A fast-blow fine wire fuses (F1 and F2 for L and N, s. section „Basis PCB connections“ in this chapter).

Intrinsic safety

StandardLine steam humidifiers comply with intrinsic safety requirements in that electrical power supply may be cut by two devices, namely the main contactor and the automatic circuit breaker.

Please note

For electrical connection of the steam humidifier a residual current circuit breaker is recommended.

11.1.1 Wiring Diagrams

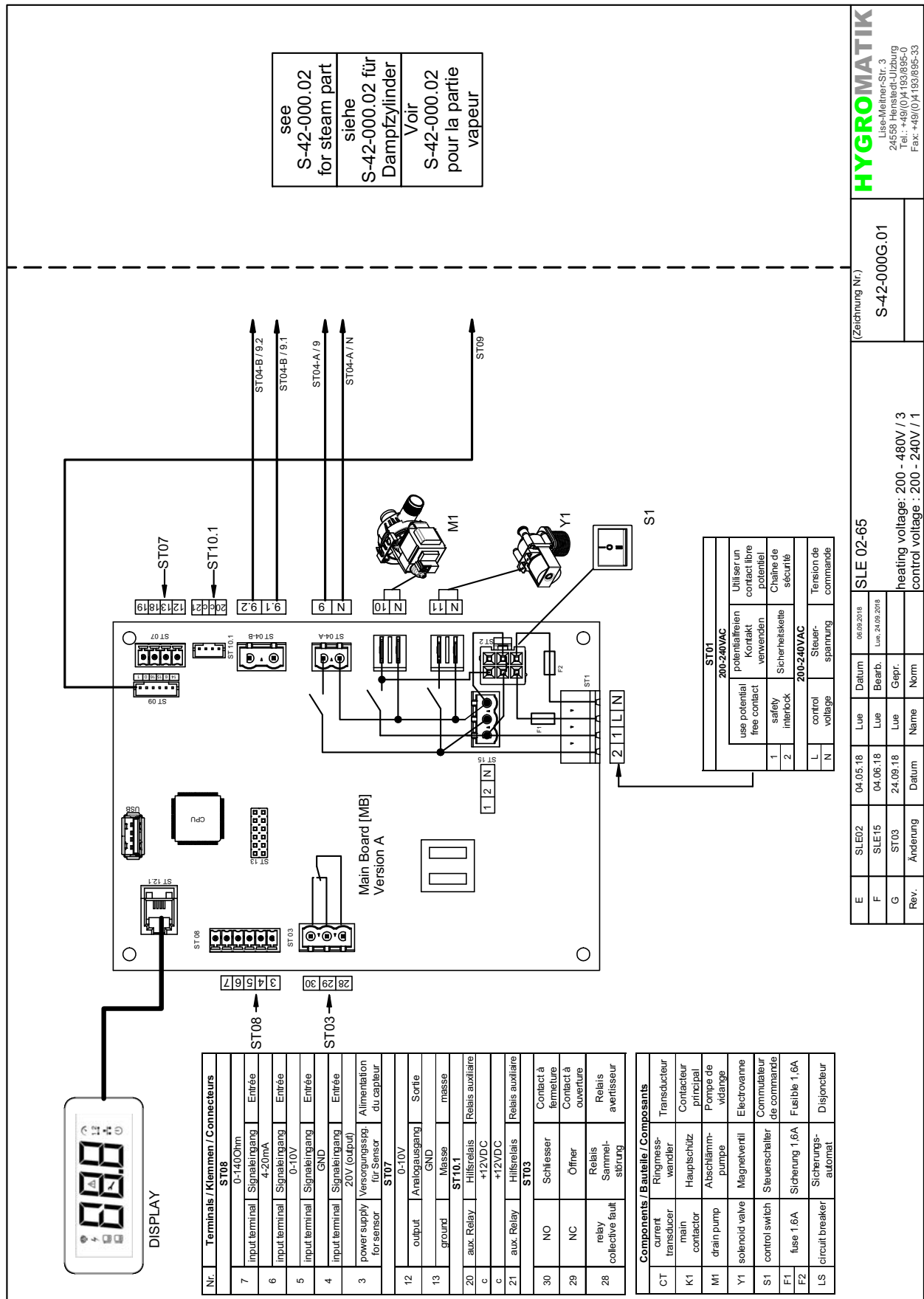

HYGROMATIK
Lise-Melner-Str. 3
24558 Henselstedt-Ujzburg
Tel.: +49(0)4193/695-0
Fax: +49(0)4193/695-33

(Zeichnung Nr.)
S-42-000G.01

SLE 02-65

E	SLE02	04.05.18	Lue	Datum	06.09.2018
F	SLE15	04.06.18	Lue	Bearb.	Lue, 24.09.2018
G	ST03	24.09.18	Lue	Gepr.	
Rev.	Änderung	Datum	Name	Norm	

heating voltage : 200 - 480V / 3
control voltage : 200 - 240V / 1

Nr.	Terminals / Klemmen / Connecteurs
7	Input terminal 0-140Ohm Signal Eingang Entrée
6	Input terminal 4-20mA Signal Eingang Entrée
5	Input terminal 0-10V Signal Eingang Entrée
4	Input terminal GND Signal Eingang Entrée
3	power supply for sensor Alimentation du capteur ST07
12	output 0-10V Analogausgang Sortie
13	ground GND Masse masse
20	aux. Relay Hilfsrelais Relais auxiliaire
c	+12VDC
21	aux. Relay Hilfsrelais Relais auxiliaire
30	NO Schliesser Contact à fermeture
29	NC Öffner Contact à ouverture
28	relay collective fault Relais avertisseur störung

Components / Bauteile / Composants	
CT	current transducer Ringmesswandler Transducteur
K1	main contactor Hauptschutz Contacteur principal
M1	drain pump Abschlamm- pumpe vidange
Y1	solenoid valve Magnetventil Electrovanne
S1	control switch Steuerschalter de commande
FL	fuse 1.6A Sicherung 1,6A Fusible 1,6A
F2	fuse 1.6A Sicherung 1,6A Fusible 1,6A
LS	circuit breaker Sicherungs- automat Disjoncteur

ST01 200-240VAC	
use potential free contact	Utiliser un contact libre potentiel
1	safety interlock
2	Chaine de sécurité
L	control voltage
N	Steuer- spannung commande

06.09.2018
Lue, 24.09.2018
Lue
Datum
Name
Norm

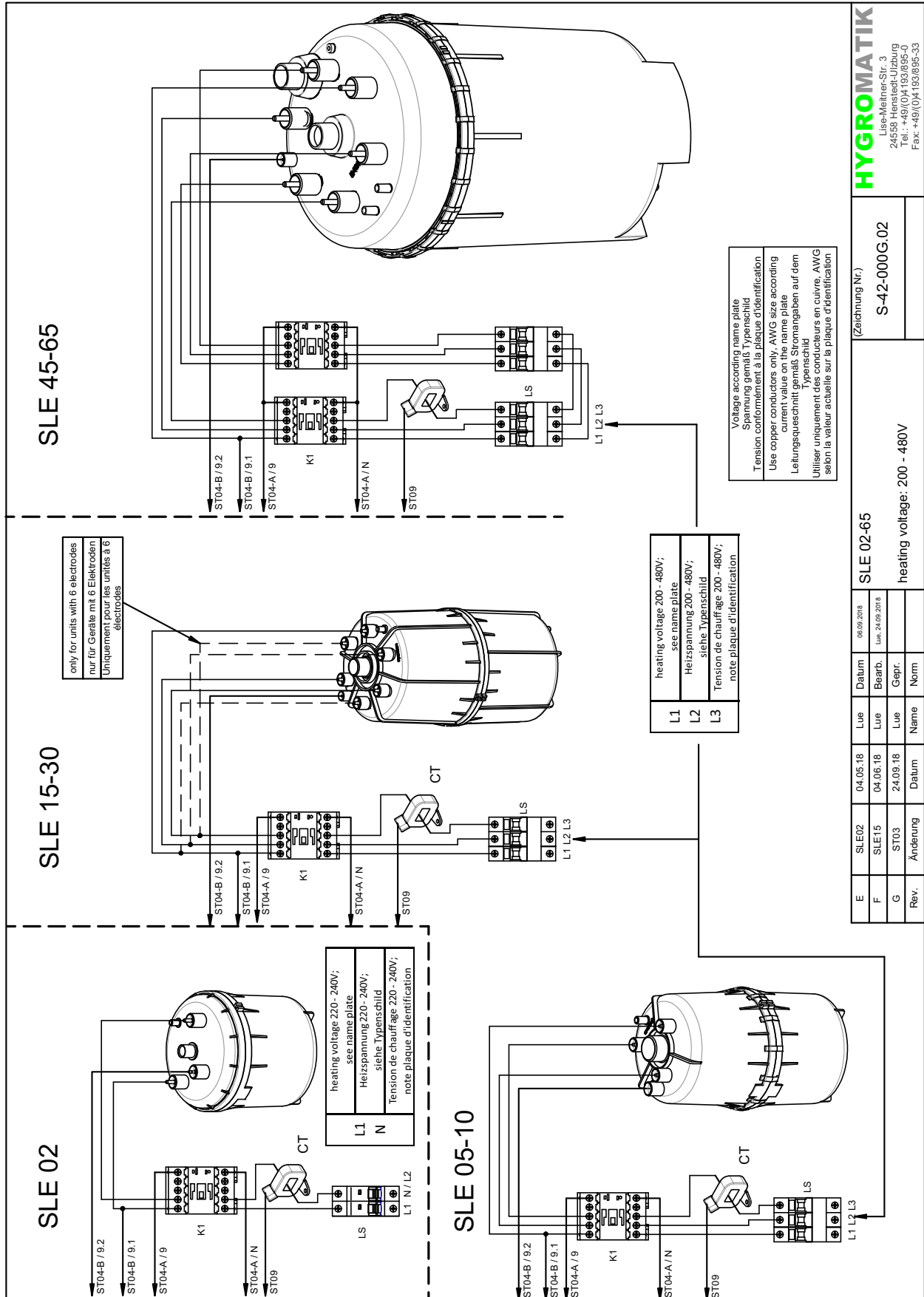

HYGROMATIK
Lise-Meher-Str. 3
24568 Hensstedt-Liitzburg
Tel.: +49(0)4193/895-0
Fax: +49(0)4193/895-33

(Zeichnung Nr.)
S-42-000G.02

SLE 02-65
heating voltage: 200 - 480V

E	SLE02	04.05.18	Lue	Datum	06.09.2018
F	SLE15	04.08.18 <th>Lue</th> <td>Bearb.</td> <td>lue, 24.09.2018</td>	Lue	Bearb.	lue, 24.09.2018
G	ST03	24.09.18 <th>Lue</th> <td>Gepr.</td> <td></td>	Lue	Gepr.	
Rev.	Änderung	Datum	Name	Norm	

Rev.	Änderung	Datum	Name	Norm

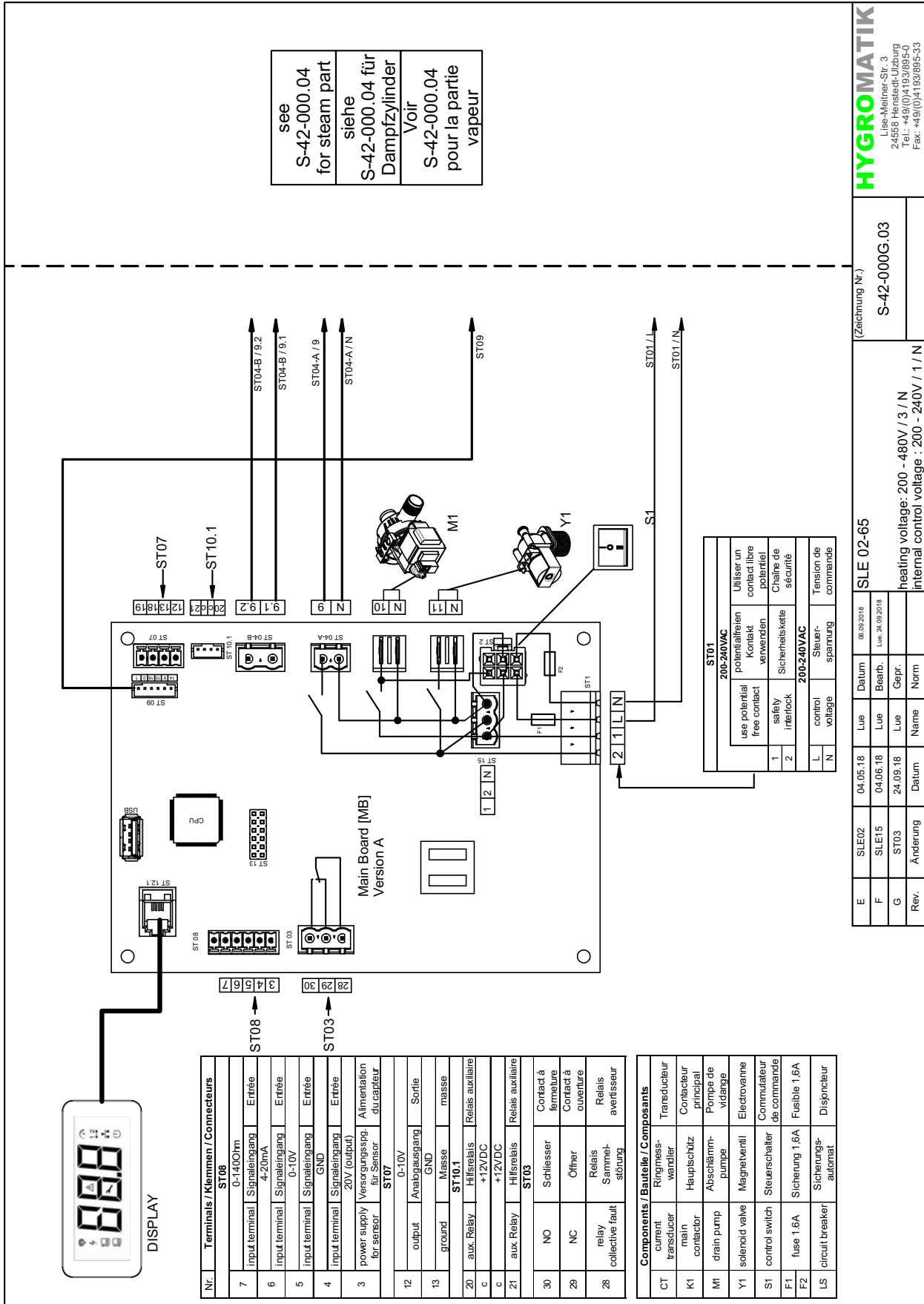

see
S-42-000.04
for steam part

siehe
S-42-000.04 für
Dampfzylinder

Voir
S-42-000.04
pour la partie
vapeur

Nr.		Terminals / Klemmen / Connecteurs
ST08		
7	Input terminal	0-140Ohm Signaleingang Entrée
6	Input terminal	4-20mA Signaleingang Entrée
5	Input terminal	0-10V Signaleingang Entrée
4	Input terminal	GND Signaleingang Entrée
3	power supply	20V (output) Versorgungsspg für Sensor Alimentation du capteur
ST07		
12	output	0-10V Anabg Ausgang Sortie
13	GND	Masse
ST10.1		
20	aux. Relay	Hilfsrelais Relais auxiliaire
c		+12VDC
c		+12VDC
ST03		
30	NO	Schliesser Contact à fermeture
29	NC	Öffner Contact à ouverture
28	relay	Relais Relais
	collective fault	Sammelstörung avertisseur
Components / Bauteile / Composants		
CT	current transducer	Ringmesswandler Transducteur
K1	main contactor	Hauptschütz Contacteur principal
M1	drain pump	Abschlamm-pumpe Pompe de vidange
Y1	solenoid valve	Magnetventil Electrovanne
S1	control switch	Steuerschalter Commutateur de commande
F1	fuse 1.6A	Sicherung 1,6A Fusible 1,6A
F2		
LS	circuit breaker	Sicherungsautomat Disjoncteur

HYGROMATIK
Lise-Melner-Str. 3
24555 Lügge
Tel: +49(0)4193/8950
Fax: +49(0)4193/895-33

(Zeichnung Nr.)
S-42-000G.03

heating voltage: 200 - 480V / 3 / N
internal control voltage : 200 - 240V / 1 / N

SLE 02-65

Rev.	Änderung	Datum	Name	Gepr.	Norm
E	SLE02	04.05.18	Lue	Datum	06.09.2018
F	SLE15	04.06.18	Lue	Bearb.	Lue, 24.09.2018
G	ST03	24.09.18	Lue	Gepr.	

heating voltage: 200 - 480V / 3 / N
 internal control voltage : 200 - 240V / 1 / N

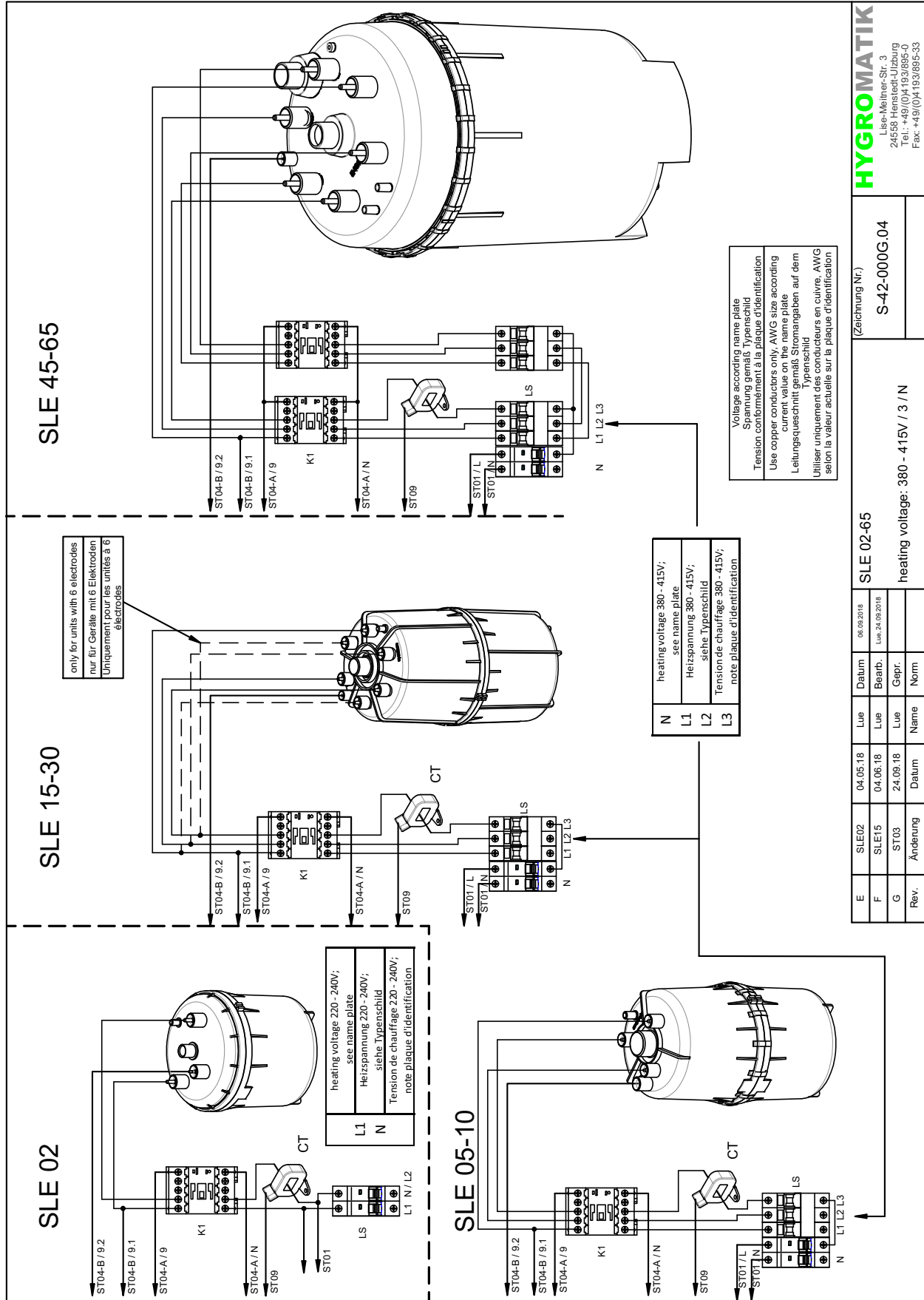

11.1.2 Mainboard inputs and outputs

11.1.2.1 Customer side interfaces

Inputs

ST08:

- Control signal 0...10 VDC
- Control signal 0...20 mA
- Control signal 0...140 Ω

Outputs

ST03:

- Potential-free programmable NC and NO contacts, (factory assignment is „collective fault“)

ST10.1:

- Connection option für 2 additional top-head rail relays (K20, K21) (ordering option)

ST07:

Control signal 0...10 VDC (max. 8 mA)

ST08:

- +20 VDC humidity sensor supply voltage (max. 20 mA)

11.1.2.2 System interfaces

Power supply and safety interlock

ST01:

- 4-pin plug connection with screw terminal adaptor for L and N power connection and safety interlock („Terminals 1/2“)

Inputs

ST09:

- Current transducer connection

ST04-B:

- Galvanically isolated sensor electrode input (via optical coupler)
- Dielectric strength 600 VAC

Outputs

ST04-A:

- Main contactor(s)

ST05:

- Blow-down pump

ST04:

- Intake solenoid valve

Bidirectional

ST12.1:

- Control panel serial interface

ST 13:

- RS485 interface adapter PCB socket

11.2 Control operation

11.2.1 Principal user guidance

On powering up the steam humidifier, the software version is shown in the display for a few seconds. In normal operation, the display then shows actual steam output as a standard display. When a key is pressed, the first reading in a list of reading and input values is indexed. The complete list may be visualized by scrolling using the „▲/▼“ keys. Control-wise, the unit is in „user level“ (see next section).

By means of inputting a 3 digit code, access to „provider level“ is possible (for input code see table in section „Provider level submenus and relating parameters“). The provider level parameters are functionally grouped in submenus (1) to (6). The code input is reset to its standard („000“), should no keystroke occur within 3 minutes.

11.2.2 Menu structure

Overview on menu structure

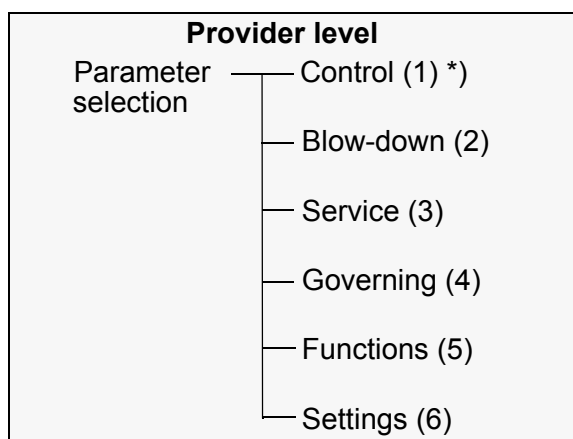
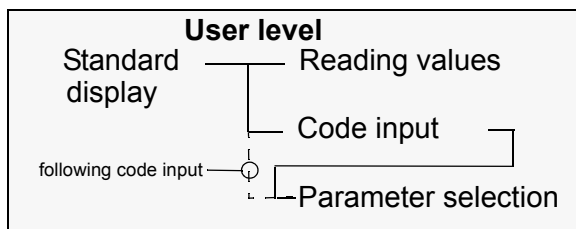

*) numbers in parenthesis are group numbers

User level

From standard display (actual steam output) user level may be accessed by pressing any key on the control panel. On user level, among other information reading values r01 to r12 are available. After a certain time span with no keystroke control switches the display back to standard display. Factory setting for this time out is „10 minutes“.

Besides showing the reading values, user level also features „P00“ for code input allowing provider level access (s. „Menu tree section“).

Provider level

On provider level, the control parameters of functional groups (1) to (6) (s. „Overview on menu structure“) may be individually changed. A tabular list of the provider level parameters and a more detailed description may be found in the sections „Provider level submenus and their parameters“ and „Detailed parameter descriptions“, respectively, further down in this chapter.

Menu tree

The detailed menu tree with all of the reading values and settable values as well as all of the parameters is depicted in the next section.

11.2.3 Menu tree

User level

Provider level⁴⁾

r01 Status
r02 Error
r03 Act. steam output [kg/h] ¹⁾
r04 Act. steam output [lbs/h] ²⁾
r05 Actual current [A]
r07 Internal demand [%]
r08 External demand [%]
r09 Power limitation [%]
r10 Set point r.h. [%] ³⁾
r11 R.h. actual value [%] ³⁾
r12 External signal [%]
r13 V-Signal
r14 mA-Signal
r15 Ω-Signal

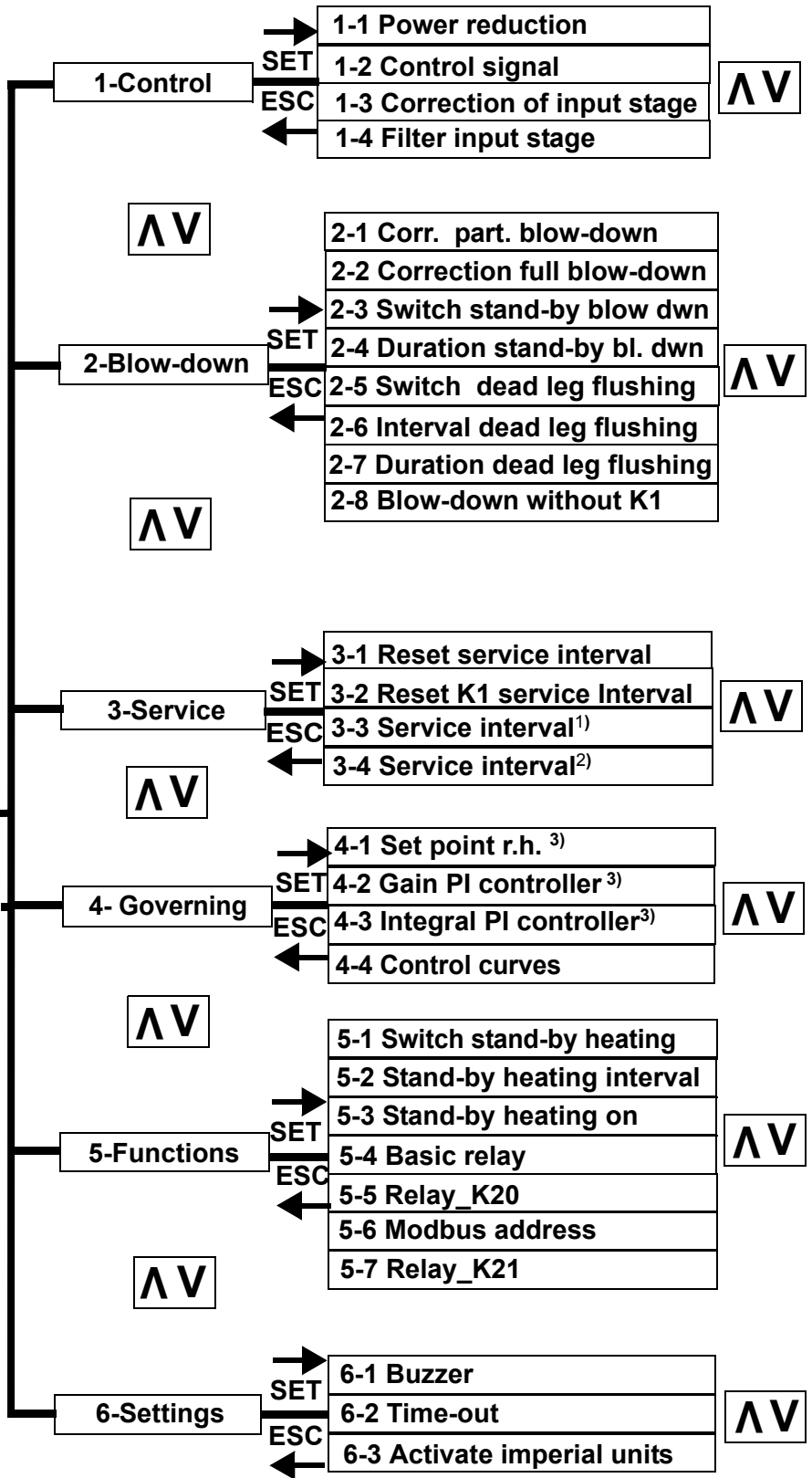
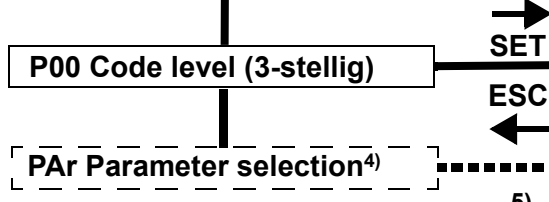

- 1) only when SI system was selected
- 2) only when imperial system was selected
- 3) only when „PI controller“ was selected
- 4) only shown after code „010“ input
- 5) direct access when on provider level

Λ V designates scrolling with control panel keys

11.3 The control panel

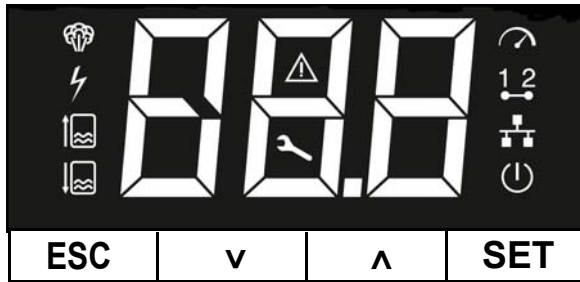

The control panel comprises 3 sections:

- the ESC, SET, **^**, **v** control keys
- the 3-digit 7-segment display
- dedicated icons for operating status indication

Please note

A flashing icon always indicates a faulty situation!

Exception: When switching the unit on, the complete display flashes 4 times. Then, the power-on-LED blinks while the device self test is run.

The **control keys** enable navigation in the menus and submenus. Their function is as follows:

„ESC“: cancellation or return to previous level

„**^**/**v**“: move up/down within a menu, submenu or selection list.

„SET“: accept and store a selected setting.

The 3-digit **7-segment-display** serves for outputting of operational and input data as well as error code presentation. When control software expects an input the digits are blinked. Display semantics are determined by lightening-up of one or more icons related to a specific operational situation or device control environment.

Icons state table

	permanently lit	flashing
	Steam production active	Cylinder full <u>In conjunction with error icon:</u> Fault steam production
	Main contactor active	Fault main contactor
	Filling active	Fault filling
	Blow-down active	Fault blow-down
	(State not possible)	Error s. error codes
	Maintenance required	(State not possible)
	Demand	Fault control signal
	Safety interlock closed	(State not possible)
	Virtual safety interlock closed by software enabling	(State not possible)
	Control active	Control self test after cold start

11.4 Navigation within a menu

User level entry

Standard display during normal operation is actual steam output in the selected dimension ([kg/h] or [lbs/h], respectively). By pressing any key, user level comprising a reading value index (pointer) selection level and the reading values as such is entered.

„r01“ is displayed indexing the first reading value.

Reading value display

By scrolling using the „▲/▼“ keys, the reading value indexes „r01“ to „r12“, code entry „P00“ (s. below) and parameter selection „PAr**“ may be addressed. The actual reading value content is output on pressing the SET key after selection of one of the reading value pointers r01 to r12.

Use the ESC key for return to the reading value index level that allows for addressing further reading values.

„P00“ allows for inputting a code for provider level entry that supports changing of the parameters (s. next section). This function is not meant for usage by the steam humidifier user.

*) „PAr“ ist only presented when a „10“ was input as the „P00“ setting value for access to provider level. When „PAr“ is confirmed with the SET key, parameter group selection is supported without the need for inputting the access code again.

Provider level code entry and setting a parameter

- » Using the „▲/▼“ keys, scroll until „P00“ is displayed and confirm with the SET key. „00“ is displayed.
- » Increase the display to „10“ using the „▲/▼“ keys and confirm with the SET key („10“ is the access code for the provider level). „1-“ is now displayed for selection of one of the parameter groups (1) to (6).
- » Confirm parameter group (1) with the SET key or make an other selection with the „▲/▼“ keys and then confirm. The display will now show a „1“ in the right digit position for addressing the parameter index (e.g., „2-1“).
- » Confirm selection with the SET key or vary selection with the „▲/▼“ keys and then confirm.

Use the ESC key for return to the previous input level.

11.5 Tabular representation of reading value list and provider level submenus

For a detailed description, pls. refer to the respective sections within this chapter.

11.5.1 The reading value list

From normal operation, the user may access the reading value index „r01“ (Status) by pressing any key.

By scrolling using the „**▲/▼**“ keys, the reading and setting values indicated in the table below may be addressed. To output the value content, the SET key must be pressed first.

Reading value index	Description
r01	Status
r02	Fault
r03	Actual steam output [kg/h] ¹⁾
r04	Actual steam output [lb/h] ²⁾
r05	Actual current [A]
r07	Internal demand [%]
r08	External demand [%]
r09	Power limitation [%]
r10	Set value r.h. [%] (only when PI controller was selected)
r11	Actual value r.h. [%] (only when PI controller was selected)
r12	External signal [%]
r13	V-Signal
r14	mA-Signal
r15	Ω-Signal
P00	Code level („0“, „10“)
PAr	Parameter group selection

¹⁾ only when SI system was selected

²⁾ only when imperial units were selected

11.5.2 Provider level submenus and relating parameters

Detailed parameter descriptions may be found in the section „Detailed parameter description“ further down in this chapter. The „Setting options“ column indicates the presettings available or the range of values to be chosen from. „Fs“ stands for „Factory setting“.

Non-permissible entries are ignored.

Submenu „Control“ (Group1)

Par.	Denomination	Setting options	Code
1-1	Power limitation [%]	25 ... 100 Fs*) = 100	10
1-2	Control signal	0= not valid 1= ext. controller, 0 ... 10 V 2= ext. contr., 0 ... 20 mA 3= ext. contr., 0..140 Ω 4= PI controller, 0 ... 10 V 5= PI controller, 4 ... 20 mA 6= PI controller, 0 ... 140 Ω 7= 1-step 8= Modbus Fs = 1	10
1-3	Correction input stages [%]	-5.0 ... +5.0 Fs = 0	10
1-4	Filter input stage	0=light, 1=strong Fs = 0	

*) Fs = Factory setting

Submenu „Blow-down“ (Group 2)

Par.	Denomination	Setting options	Code
2-1	Correction partial blow-down	-5...+5 Fs = 0	10
2-2	Correction full blow-down	-5...+5 Fs = 0	10
2-3	Switch stand-by blow-down	0=off, 1=on Fs = 1	10
2-4	Waiting time stand-by blow-down [h]	0.1...48.0 Fs = 24.0	10
2-5	Switch dead leg flushing	0=off, 1=on Fs = 0	10
2-6	Interval dead leg flushing [h]	0.1...96.0 Fs = 24.0	10
2-7	Duration deadleg flushing [s]	1...600 Fs = 90	10
2-8	Blow-down without K1	0=no, 1=yes Fs = 0	10

Submenu „Service“ (Group 3)

Par.	Denomination	Setting options	Code
3-1	Reset service interval steam amount	0=no, 1=yes Fs = 0	10
3-2	Reset K1 service interval	0=no, 1=yes Fs = 0	10
3-3	Service interval [t]	0...90.0 Fs = device dependant	10
3-4	Service interval [tn. sh.]	0 ...90.0 Fs = device dependant	10

Submenu „Governing“ (Group 4)

Par.	Denomination	Setting options	Code
4-1	Set point r.h. [%] (PI controller only)	5...99.9 Fs = 50.0	10
4-2	Gain [%] (PI controller only)	0.1...99.9 Fs = 5.0	10
4-3	Integral [%] (PI controller only)	0...100.0 Fs = 10	10
4-4	Control curve	0 = energy optimisation 1 = load optimisation Fs = 1	10

Submenu „Functions“ (Group 5)

Par.	Denomination	Setting options	Code
5-1	Switch stand-by heating	0=off, 1=on Fs = 0	10
5-2	Interval stand-by heating [min]	1...999 Fs = device dependant	10
5-3	Stand-by heating [s]	1...999 Fs = device dependant	10
5-4	Basic relay	0 = Collective fault 1 = Stand-by 2 = No demand 3 = Humidifying 5 = Remote off 30 = Filling off 31 = Filling on 37 = HyCool 60 = Blow-down off 61 = Blow-down on 62 = Partial blow-down 63 = Full blow-down 64 = Dilution 65 = Overcurrent blow-down 67 = Stand-by blow-down 68 = Dead leg flushing 270 = Collective Service Fs = 0	
5-5	Relay_K20 (optionally)	same as for basic relay Fs = 270	10
5-6	Modbus address	1...255 Fs = 1	10
5-7	Relay_K21 (optionally)	same as for basic relay Fs = 270	10

Submenu „Settings“ (Group 6)

Par.	Denomination	Setting options	Code
6-1	Buzzer	0=off, 1=on Fs = 0	10
6-2	Time-Out (return to standard display) [min]	0 ... 60 Fs = 2	10
6-3	Activate imperial units	0 = SI units 1 = imperial units Fs = 0	10

11.6 Exemplary variation of a parameter setting

Example: Control signal is to be changed from „Ext. controller, 0 ...10V“ („1-2“ = „1“) to „PI controller, 0 ...10V“ („1-2“ = „4“).

Please note

The steps below make an essential change to a control parameter. If this is not intended, be sure to reestablish the original setting after changing it for exercising purposes.

- » In normal operation, press any key to access the reading value list. „r01“ is displayed.
- » Scroll from „r01“ to „P00“ (Code input).
- » Press SET key. Display now shows a flashing „Zero“ for code level „0“ (user level) and input readiness.
- » Using the „▲/▼“ keys, change the display to „10“.
- » Press the SET key. Provider level is now entered. „1-“ is displayed as the first parameter group to be changed.
- » Since the parameter is in this group, group confirmation can be made immediately with the SET key.
- » Scroll with the „▲/▼“ keys to the „1-2“ position and confirm with the SET key. The parameter setting „1“ (external controller, 0...10V) is displayed and may be changed.
- » Change the setting to „4“ (PI controller, 0...10V) with the „▲/▼“ keys and confirm with the SET key.
- » Pressing the ESC key twice brings the display back to standard display (i.e. actual steam output).

These steps are exemplary. In the same way, selection and variation of all of the parameters may be accomplished.

11.7 Detailed description of the user level reading values and settings

Reading value pointer		Explanation	
r01 Status	Code	Denomination	Description
Main functions category	00	Start	Humidifier is in startup phase after a cold start. The Power-ON-LED flashes.
	01	Stand-by	Safety interlock is open (safety interlock icon in display is not lit). No steam is produced. In case of the safety interlock being opened by software, status „05“ (Remote off) is displayed instead of „01“.
	02	No demand	Demand from external controller or active humidity sensor is below switch-on threshold of the steam humidifier. No steam is produced (while the safety interlock is closed). The demand icon in the display is not lit.
	03	Humidify	Steam is produced when demand is generated by a Hygrostat or an external controller. With a PI controller setting, an input signal from the active humidity sensor is required. (Safety interlock must be closed).
	05	Remote off	Safety interlock was opened via Modbus (e.g. by a building control system instruction).
	06	No Modbus	When 1-2 = „Modbus“ is selected, demand messages are required on a regular base. In case of no demand within a 20 s time frame, „No Modbus“ is shown as the device status and steam production is stopped (for details, see dedicated Modbus documentation available from HygroMatik GmbH).
	07	Stand-by heating interval	When in stand-by heating mode, status code 07 is displayed during steam production.
	08	Stand-by heating pause	When in stand-by heating mode, status code 08 is displayed when no steam is produced.
Filling category	30	Filling	Filling is active via solenoid valve. The filling icon in the display is lit.
Blow-down category	60	Initial blow-down	After switching the device on, a blow-down sequence is run with the parameter set for partial blow-down.
	61	Partial blow-down	A partial blow-down is run in order to achieve cylinder water concentration reduction. The blow-down icon in the display is lit.

Reading value pointer		Explanation	
Blow-down category (ctd.)	62	Full blow-down	Full blow-down is run (steam cylinder is completely drained). The blow-down icon in the display is lit.
	63	Dilution	A partial blow-down is run (with the parameter set for partial blow-down) due to a water conductivity too high. The blow-down icon in the display is lit.
	64	Overcurrent blow-down	An overcurrent blow-down is run since an electrode current too high was detected by the device. Reducing water level also reduces electrode current. The blow-down icon in the display is lit.
	66	Stand-by blow-down	In case of a safety interlock open for a longer period of time, a full blow-down is run automatically after a time preset in order to avoid stagnant water in the steam cylinder. The blow-down icon in the display is lit.
	67	Dead leg flushing	Special blow-down mode for flushing dead leg tubing. Solenoid valve and blow-down pump are activated simultaneously in case of a no demand situation for a certain period of time. The blow-down icon in the display is lit.
	80	Partial blow-down waiting	Device will start partial blow-down with next filling step.
	81	Full blow-down waiting	Device will start full blow-down with next filling step.
Monitoring category	90	Cylinder full	On detection of a an electrical potential at the sensor electrode, cylinder full is reported. In this situation cylinder water level is so high that an electrical bridge between one of the power electrodes and the sensor electrode has built up. The steam icon in the display flashes.
Service category	271	Service steam amount	The service threshold for the steam amount produced as preset in 3-3 (SI units) or 3-4 (imperial units) was exceeded. The service icon in the display is permanently lit for the time the message is active. The status message may be reset by setting parameter 3-1 to „1“.
	272	Service main contactor K1 switching cycles	The number of main contactor switching cycles predefined by the manufacturer was met. A main contactor replacement is advisable. The service icon in the display is permanently lit for the time the message is active. For resetting the status message, parameter 3-2 must be set to „1“.
Fault category	999	Fault	A fault was detected. Operation has ceased. An error code may be read out. Some certain faults also make an icon in the display blink.

Reading value pointer	Explanation
r02 Error (only shown when a fault has occurred)	The error code related to the fault is displayed (steam production is stopped whenever a fault occurs). Error codes are described in the „Trouble shooting“ chapter of this manual.
r03 Actual steam output (SI units)	Amount of current steam production value [kg/h]
r04 Actual steam output (imperial units)	Amount of current steam production value [lb/h]
r05 Actual current	Current electrode amperage value [A]
r07 Internal control signal	The internal signal for controlling the steam humidifier electrical power delivery to the electrodes is displayed. [%]. This reading is influenced by the control curve and a power limitation preset
r08 External demand (only with ext. controller)	External controller control signal is displayed [%]
r09 Power limitation	Power limitation as a percentage of max. output as preset in parameter „1-1“ is displayed [%]
r10 Set point r.H. (only when PI controller was preset)	R.h. nominal value as preset in parameter 4-1 is displayed [%]
r11 Actual value r.h. (only when PI controller was preset)	Actual value of r.h. is displayed [%].
r12 External signal	External signal [%]
r13 V-Signal	Input signal measured at terminal ST805 [V]
r14 mA-Signal	Input signal measured at terminal ST806 [mA]
r15 Ω-Signal	Input signal measured at terminal ST807 [Ω]

Set value	Explanation
P00 Code level	Allows provider level access by code input (Code „010“) or limitation to user level (Code „0“). Provider level is exited automatically after 10 mins without a keystroke.
PAr Parameter selection	Allows selection of parameter group and of a specific parameter within a group.

11.8 Detailed parameter descriptions

Group	Par.	Denomination	Description
Control	1-1	Power limitation	Power limitation allows scaling down the max. (steam) output within a range of 25 to 100 %, which may be necessary for a better control performance. The actual steam output is determined by the control signal.
	1-2	Control signal	This parameter tells the unit control software what kind of control signal is wired. Also, the control characteristic is defined. These are the setting options: 1 = external controller, 0...10 V 2 = external controller, 0...20 mA 3 = external controller, 0...140 Ω 4 = PI controller, 0...10 V 5 = PI controller, 4...20 mA 6 = PI controller, 0...140 Ω 7 = 1-step 8 = Modbus
	1-3	Correction of input stages	This parameter allows for an active humidity sensor calibration in the range from -5% r.h. to +5% r.h. .
	1-4	Filter input stage	This parameter allows for switching the damping of the input low pass filter from „light“ to „strong“. With a capacitive humidity sensor, increasing the input damping is meaningful for improving the signal-to-noise ration and for reducing the oscillating tendency.
Blow-down	2-1	Correction partial blow-down	In case of high electrical conductivity of water or excessive maintenance effort, increasing the blow-down frequency may be meaningful. When conductivity is low, however, a lower blow-down frequency may be adequate. To cope with different water qualities, blow-down rates may be adapted within a range of 10 stages (factory presetting is „0“). Increase blow-down rate: settings up to +5. Decrease blow-down rate: settings up to - 5. A blow-down rate too low will lead to significant wear and tear and will also increase the maintenance effort required. Pls. note: a „-5“ setting will shut off blow-down completely!

Group	Par.	Denomination	Description
Blow-down	2-2	Correction full blowdown	see correction partial blow-down
	2-3	Switch stand-by blow-down	Should steam humidifier operation be prospectively halted for a longer period of time, blowing-down the cylinder water is advisable in order to comply with the VDI 6022 hygiene regulations prescribing the prevention of microbial contamination of residual water. Parameter 2-3 is the switch to activate and de-activate the stand-by blow-down function. When activated, a full blow-down is run after a waiting time that was determined by setting parameter 2-4 to the value in question. For stand-by blow-down to become effective, the unit control switch must remain in the „On“- position („I“).
	2-4	Waiting time stand-by blow-down	Determines the waiting time until the cylinder water is fully drained to counteract contamination when no steam is produced for a lengthy period of time (factory setting is 24 hours).
	2-5	Switch „dead leg flushing“	When parameter 2-5 = „1“, for flushing of the supply line, solenoid and blow-down pump are simultaneously activated after the time preset in parameter 2-6 and for the duration of time preset in 2-7. In order for this to work, the safety interlock must be closed.
	2-6	Interval dead leg flushing	Waiting time [h] until dead leg flushing is activated when switch 2-5 = „1“.
	2-7	Duration dead leg flushing	Duration of dead leg flushing [s].
	2-8	Blow-down without main contactor K1	During blow-down, leakage currents may flow towards ground through cylinder water. In order to avoid the activation of the leakage sensor circuit-breaker, the main contactor K1 may be switched off during pumping (2-8 = „1“ is designated to „main contactor is switched off during pumping“).

Group	Par.	Denomination	Description
Service	3-1	Reset steam-service interval	On finishing maintenance work, the service interval is to be reset (the service icon is blanked if it was illuminated before).
	3-2	Reset K1 service interval	Main contactor switching cycles are monitored and compared to the life expectancy figure supplied by the part's manufacturer. On a match, reading value r01 is set to „270“ (and the service icon LED flashes). After changing the main contactor, parameter 3-2 must be set to „1“ for a reset of the status message.
	3-3	Service interval [t]	same as 3-4 (only relevant when the SI system was selected)
	3-4	Service interval [tn.sh.]	<p>Unit control monitors the actual steam amount produced and compares it with the service steam amount that was determined by the parameter 3-4 setting. When the two data match, the service icon is lit. Steam humidifier operation is not disrupted.</p> <p>Service rate highly dependants on water quality (conductivity, hardness) and on the amount of steam produced since the last service. By varying parameter 3-4, the service interval may be adjusted to water quality.</p>
Governing These parameters are only effective when parameter 1-2 (control signal) holds a setting incorporating the PI controller.	4-1	Set point r.h.	Parameter 4-1 determines the r.h. set point for control.
	4-2	Gain PI controller	Sets the PI controller gain (Xp) [%].
	4-3	Integral PI controller	Sets the PI controller resetting time (Xn).
	4-4	Control curves	By setting this parameter, electrode driving may be varied between energy-optimised (4-4 = „0“) and load-optimised (4-4 = „1“). In the first case, when a cold start is run, current is increased to 1.28 times the nominal current. When „load-optimised“ was selected, the increasing factor is only 1.1 in order to not overload the power supply.

Group	Par.	Denomina- tion	Description
Functions	5-1	Switch stand-by heating	Stand-by heating is enabled or not (0= off, 1=on).
	5-2	Interval stand-by heating	Parameter 5-2 determines the interval time between heating phases when stand-by heating was enabled.
	5-3	On-time Stand-by heating	Parameter 5-3 sets the heating on-time when stand-by heating was enabled.
	5-4	Basic relay allocation	<p>The basic relay offers potential-free NC and NO contacts across terminals 28,29 and 29,30, respectively on the ST03 connector (contact capacity is 250 VAC/8A).</p> <p>The relay is activated when a certain operating status is achieved. Parameter 5-4 allows for allocating a logical function, i.e. the relay is energised when a certain operating status occurs. Factory setting is „0“ defined as „collective fault“</p> <p>The following allocations are supported:</p> <p>(0) Collective fault: Relay is energised in case of any fault.</p> <p>(1) Stand-by: Relay is energised when the unit is in stand-by.</p> <p>(2) No demand: Relay is energised when input signal creates no demand.</p> <p>(3) Humidifying: Relay is energised when humidifying is active.</p> <p>(5) Remote off: Relay is energised when safety interlock was opened under software by means of the building control system.</p> <p>(30) Filling off: Relay is energised when filling is not active.</p> <p>(31) Filling on: Relay is energised when filling.</p>

Group	Par.	Denomination	Description
Functions	5-4	Basic relay allocation (ctd.)	<p>(37) HyCool: Relay is energised for switching on HyCool-function solenoid valve.</p> <p>(60) Blow-down off: Relay is energised when not pumping.</p> <p>(61) Blow-down on: Relay is energised when pumping takes place.</p> <p>(62) Partial blow-down: Relay is energised when a partial blow-down is run.</p> <p>(63) Full blow-down: Relay is energised when a full blow-down is run.</p> <p>(64) Dilution: A partial blow-down is run due to a water conductivity too high.</p> <p>(65) Overcurrent blow-down: Relay is energised when an overcurrent blow-down is run.</p> <p>(67) Stand-by blow down: Relay is energised when a stand-by blow-down is run.</p> <p>(68) Dead leg blow-down: Relay is energised when a dead leg blow-down is run.</p> <p>(270) Collective Service: Relay is energised when a service message status („Service steam amount“, „Service main contactor K1 switching cycles“) is active.</p>
	5-5	Relay_K20 allocation (ST10.1)	Defines logical function of relay K20 contacts (in the same way as 5-4 does for the basic relay). Factory preset is „270“ (collective service).
	5-6	Modbus address	The control electronics may optionally be equipped with a RS485 serial interface for running data communication with the Modbus RTU protocol. 5-6 then holds the Modbus RTU address.
	5-7	Relay_K21 allocation (ST10.1)	Defines logical function of relay K20 contacts (in the same way as 5-4 does for the basic relay). Factory preset is „270“ (collective service).
	Settings	6-1	Buzzer
6-2		Time-Out	Unit control switches the display back to actual steam output presentation after the time set in 6-2. Factory setting is „2 minutes“
6-3		Imperial units	This parameter enables a switch between SI units and imperial units. Actual steam output e.g. will then be in „lb/h“ instead of „kg/h“.





12. Trouble shooting



12.1 Error handling







On occurrence of a fault, steam production is stopped. The control panel display is switched to error code output. In the same instance, the general fault icon  starts flashing.



On „Steam production“, „Main contactor“, „Filling“ and „Blow-down“ faults, the respective icon is additionally blinked.

12.1.1 Table of possible faults and related error codes

Icons	Code	Error message	Possible cause	Counter measure
	000	No error		
	001	Current sensor plug	Plug not attached or loose	Check plug
	020 021 *)	Min./max. reference for voltage control signal not correct Software has detected implausibility	<ul style="list-style-type: none"> • Sensor, input wiring or signal source not correct • Input stage defective 	<ul style="list-style-type: none"> • Check sensor, signal cable and signal source, if applicable • Replace main PCB
	022 023 *)	Min./max. reference for current control signal not correct Software has detected implausibility	<ul style="list-style-type: none"> • Sensor, input wiring or signal source not correct • Input stage defective 	<ul style="list-style-type: none"> • Check sensor, signal cable and signal source, if applicable • Replace main PCB
	024 025 *)	Min./max. reference for resistive control signal not correct Software has detected implausibility	<ul style="list-style-type: none"> • Sensor, input wiring or signal source not correct • Input stage defective 	<ul style="list-style-type: none"> • Check sensor, signal cable and signal source, if applicable • Replace main PCB
*) When a PI controller is in use, errors 020-025 relate to the sensor output signals. With an external controller the controller output signal is concerned.				
	029	System failure	<ul style="list-style-type: none"> • Main PCB is defective 	<ul style="list-style-type: none"> • Replace main PCB

Icons	Code	Error message	Possible cause	Counter measure
 	<p>030</p>	<p>Filling</p> <p>Filling was not successful, i.e. , after 30 mins of filling time the expected level was not achieved.</p>	<ul style="list-style-type: none"> • Solenoid valve or water supply line contaminated or defective • Solenoid valve defective • Water supply not opened • Solenoid valve electrically not driven <ul style="list-style-type: none"> - electrical cabling not o.k. - Main PCB relay not energised • Steam hose not laid with sufficient incline/ decline resulting in a water bag obstructing steam flow. Steam builds up pressure in steam cylinder and pushes water towards drain • L3 phase break-down • Main contactor does not switch L3 phase 	<ul style="list-style-type: none"> • Clean water supply line and/or solenoid valve; replace solenoid valve, if defective • Make measurement on solenoid; replace solenoid valve, if defective • Open water supply -Check electrical cable and replace, if required - Measure voltage on main PCB terminal 11 against N; replace PCB, if required • Check steam hose layout. Eliminate water bag. • Reestablish L3 phase feeding • Replace main contactor

Icons	Code	Error message	Possible cause	Counter measure
 	061 062 063 064	Blow-down fault, relates to: Partial blow-down Full blow-down Dilution Overcurrent blow-down A partial/full/overcurrent/dilution blow-down was not successful	<ul style="list-style-type: none"> • Blow-down pump not driven <ul style="list-style-type: none"> - electrical wiring not o.k. - Main PCB relay not energised • Blow-down pump defective • Blow-down pump working but water is not drained (i.e. cylinder drain is blocked) • Blow-down pump blocked by hardeners 	<ul style="list-style-type: none"> - Check wiring and replace, if required - Measure voltage on main PCB terminal 10 against N; replace PCB, required if • Replace blow-down pump • Clean cylinder and cylinder base carefully to ensure that no blocking will occur in the near future • Check blow-down pump, drainage system and steam cylinder for hardeners and clean
 	090	Cylinder full Sensor electrode continuously signals full cylinder for 60 mins	<ul style="list-style-type: none"> • Check blow-down pump, drainage system and steam cylinder for hardeners and clean • Electrodes used up • No electrode cable run through current transducer • Salt bridges in steam-cylinder upper part • Foaming (when softened water is used) 	<ul style="list-style-type: none"> • Check feed water quality • Replace electrodes • Run one phase through current transducer • Clean • Increase blending rate
  	091	Current measurement Current transducer supplies faulty measurement	<ul style="list-style-type: none"> • Plug is not seated properly on main PCB • Current transducer defective 	<ul style="list-style-type: none"> • Check plug seating • Replace current transducer

Icons	Code	Error message	Possible cause	Counter measure
	092	Main contactor current Current measured though the main contactor is not driven	<ul style="list-style-type: none"> • Main contactor contact sticks 	<ul style="list-style-type: none"> • Replace main contactor
	093	Main contactor cylinder full „Cylinder full“ is detected though main contactor is not driven	<ul style="list-style-type: none"> • Main contactor contact sticks 	<ul style="list-style-type: none"> • Replace main contactor
	210	R.h. sensor Humidity sensor signal implausibility	<ul style="list-style-type: none"> • Sensor cable defective • Sensor defective 	<ul style="list-style-type: none"> • Check sensor cable • Replace sensor
	ErL	Error Link no communication between mainboard and display	<ul style="list-style-type: none"> • Mainboard or display unit defective 	<ul style="list-style-type: none"> • Replace mainboard or display unit

12.2 Table of functional disruptions

Problem	Possible cause for faulty situation	Counter measure
Set humidity level not reached	<ul style="list-style-type: none"> • Output limitation parameter setting impedes full power output • Nominal unit output insufficient • Phase failure • Lengthy steam hose layout crossing cold and drafty rooms may lead to increased condensate formation • Improper steam manifold installation may cause condensate formation within air duct • Control signal not properly selected or software setting mismatch • Water quality requires water concentration for full steam output • Excessive pressure in duct system caused by e.g. water bags or partly blocked steam pipes (max. overpressure is 1200 Pa) 	<ul style="list-style-type: none"> • Check 1-1 parameter setting • Check unit technical data, air-flow and secondary airflow • Check circuit breakers • Change unit installation location allowing for shorter steam hose. Insulate steam hose • Check steam manifold position within total system and installation correctness • Check control signal and 1-2 parameter setting • Wait • Eliminate particular cause(s)
Excessive humidity	<ul style="list-style-type: none"> • A steam output limitation setting that is too high may result in poor control performance and even condensate formation in ducts • Control signal not properly selected or software setting mismatch 	<ul style="list-style-type: none"> • Check 1-1 parameter setting • Check control signal and 1-2 parameter setting
Water collects on bottom plate	<ul style="list-style-type: none"> • Cylinder improperly reassembled following maintenance: <ul style="list-style-type: none"> - O-ring not replaced, defective or not in place - Flange (tongue and groove) damaged - Flange improperly composed - Mineral deposits in flange area • Cylinder improperly inserted in cylinder base • Water cannot drain freely when pumped from cylinder 	<ul style="list-style-type: none"> • Clean cylinder and assemble / install properly • Using moistened new O-ring, insert steam cylinder properly into cylinder base • Make sure drain is unobstructed

Problem	Possible cause for faulty situation	Counter measure
Water leaks from steam cylinder upper part	<ul style="list-style-type: none"> • Hose clamps on steam and/or condensate hose not tightened • Steam hose adapter not properly fit or O-ring not replaced 	<ul style="list-style-type: none"> • Tighten clamps • Replace O-ring (if required) and ensure proper adapter installation
No steam production despite the steam humidifier being switched on. Display not illuminated.	<ul style="list-style-type: none"> • Defective F1 and/or F2 fuses (1.6 A each) • L3 phase failure (ext. circuit breaker has tripped or is defective) • device load circuit breaker has tripped 	<ul style="list-style-type: none"> • Check micro fuses and replace, if required • Replace breaker and investigate possible causes • Switch on breaker. If problem persists, check for reason
Blow-down pump works but not water is drained	<ul style="list-style-type: none"> • Steam cylinder and/or drainage system blocked 	<ul style="list-style-type: none"> • Clean cylinder base and/or drainage system, respectively
Cylinder is fully drained after partial blow-down despite pump being switched off	<ul style="list-style-type: none"> • Vent pipe is blocked 	<ul style="list-style-type: none"> • Clean venting bore or replace vent pipe adapter
<p>No steam exit from steam manifold</p> <p>Water exits periodically from drain hose without pump switched on</p>	<ul style="list-style-type: none"> • Steam pipe improperly laid (water bag). • Excess pressure in duct system (max. overpressure is 1200 Pa) 	<ul style="list-style-type: none"> • Rerun steam hose according to guide lines • Consult your expert dealer if problem persists
Uneven electrode wear	<ul style="list-style-type: none"> • One or more electrodes not supplied with power • Circuit breaker tripped • Main contactor contact not functional • Phase loading not symmetric • Electrode immersion depth differs. Unit not mounted plumb 	<ul style="list-style-type: none"> • Check power supply and wiring • Check circuit breaker. Replace, if required • Check main contactor. Replace, if required • Ensure power supply phase balance by measurement • Check installation and correct positioning, if required

Problem	Possible cause for faulty situation	Counter measure
Flashover/sparks in cylinder	<ul style="list-style-type: none"> • Very high water conductivity resulting in massive electrode burn-off as indicated by brown-black deposits • Blow-down pump not working properly or defective 	<ul style="list-style-type: none"> • Deactivate unit immediately to prevent material damage <p>Perform maintenance:</p> <ul style="list-style-type: none"> - replace electrodes - clean steam cylinder - check water quality and conductivity (also s. „Intended use“ section) <p>If problem persists, increase blow-down frequency and/or blow-down volume</p> <p>Consult your expert dealer, if required</p> <ul style="list-style-type: none"> • Check blow-down pump functioning and replace pump, if required. See also „Blow down fault“ error message

13. Declaration of Conformity

EU Konformitätserklärung *EU Declaration of Conformity*

Hersteller / Manufacturer: HygroMatik GmbH
Anschrift / Address: Lise-Meitner-Straße 3, D-24558 Henstedt-Ulzburg, Germany
Produktbezeichnung: / Product description **StandardLine Electrode (SLE):**
 SLE02, SLE05, SLE10, SLE15, SLE20, SLE30, SLE45, SLE65

Die bezeichneten Produkte stimmen in der von uns in Verkehr gebrachten Ausführung mit den Vorschriften folgender Europäischer Richtlinien überein:

The products described above in the form as delivered are in conformity with the provisions of the following European Directives:

- 2014/30/EU** Richtlinie des Rates zur Angleichung der Rechtsvorschriften der Mitgliedstaaten über die elektromagnetische Verträglichkeit.
Council Directive on the approximation of the laws of the Member States relating to electromagnetic compatibility.
- 2014/35/EU** Richtlinie des Rates zur Angleichung der Rechtsvorschriften der Mitgliedstaaten betreffend elektrische Betriebsmittel zur Verwendung innerhalb bestimmter Spannungsgrenzen.
Council Directive on the approximation of the laws of the Member States related to electrical equipment designed for use within certain voltage limits.

Die Konformität mit den Richtlinien wird nachgewiesen durch die Einhaltung folgender Normen:
Conformity to the Directives is assured through the application of the following standards:

Referenznummer:	Ausgabedatum:	Referenznummer:	Ausgabedatum:
<i>Reference Number:</i>	<i>Edition:</i>	<i>Reference Number:</i>	<i>Edition:</i>
DIN EN 61000-6-2	2006-03	DIN EN 60335-1	2012-10
DIN EN 61000-6-3	2011-09	DIN EN 60335-1 Ber.1	2014-04
DIN EN 62233	2008-11	DIN EN 60335-2-98	2009-04
DIN EN 62233 Ber.1	2009-04		

Das Produkt entspricht den Anforderungen des deutschen Produktsicherheitsgesetzes ProdSG hinsichtlich der Gewährleistung von Sicherheit und Gesundheit. Produktänderungen nach Auslieferung können zum Verlust der Konformität führen.
The requirements of the German Product Safety Law ProdSG regarding the ensurance of safety and health are met. Product modifications after delivery may result in a loss of conformity.

Henstedt-Ulzburg, den / the 03.04.2017

HygroMatik GmbH

 Dirc Menssing
 Geschäftsführer / General Manager

 i.V. Frank Michaelsen
 Leitung Technik / Head of Engineering

Diese Erklärung bescheinigt die Übereinstimmung mit den genannten Richtlinien, ist jedoch keine Zusicherung von Eigenschaften. Die Sicherheitshinweise der mitgelieferten Produktdokumentation sind zu beachten.
This declaration certifies the conformity to the specified directives but contains no assurance of properties. The safety documentation accompanying the product shall be considered in detail.

14. Spare Parts

*	SLE02	SLE05 SLE10	SLE15	SLE20	SLE30	SLE45	SLE65	Article No.	Description
Steam generation									
	1							SP-01-00000	Steam cylinder CY2 complete
16		1						SP-03-00000	Steam cylinder CY08 complete
16			1					SP-04-00002	Steam cylinder CY17 complete with 3 electrodes
16				1				SP-04-00000	Steam cylinder CY17 complete with 3 electrodes
16					1			SP-04-00100	Steam cylinder CY17 complete with 6 electrodes
16						1	1	SP-06-00000	Steam cylinder CY45/2 complete with 6 electrodes
	1							B-3204043	Electrodes without hand nuts, set=2pcs
48		1						B-3204021	Electrodes without hand nuts, set=3pcs
48			1					B-2204087	Electrodes without hand nuts, set=3pcs
48				1				B-2206221	Electrodes without hand nuts, set=3pcs
48					1			B-2204089	Electrodes without hand nuts, set=6pcs
48						1	1	B-2204091	Electrodes without hand nuts, set=6pcs for CY45 (until
48						1	1	SP-06-00010	Electrodes without hand nuts, set=6pcs for CY45/2 (from
	1							B-3204047	Sensor electrode without hand nut
10		1						B-3204029	Sensor electrode without hand nut
10			1	1	1	1	1	B-2204073	Sensor electrode without hand nut
	1							B-2207099	Hand nuts M6 for cylinder CY2, set=2pcs
49		1						B-2207101	Hand nuts M6 for cylinder CY08, set=3pcs
49			1	1				B-2207103	Hand nuts M8 for cylinder CY17, set=3pcs
49					1			B-2207105	Hand nuts M8 for cylinder CY17, set=6pcs
49						1	1	B-2207107	Hand nuts M10 for cylinder CY45 and CY45/2, set=6pcs
8	1	1	1	1	1	1	1	E-2204202	Hand nut M6, grey, for sensor electrode
18	1	1		1	1	1	1	B-3216021	Cylinder flange clamps, set=24pcs
37	1	1						E-3220002	Cylinder base
37			1	1	1	1	1	E-2206090	Cylinder base
	1	1						B-2214023	Mounting set for cylinder base
			1	1	1	1	1	B-3216023	Mounting set for cylinder base
	1							E-3221000	Adapter for Steam hose for steam cylinder CY02
1		1	1					E-2209018	Adapter for Steam hose for steam cylinder CY08
1				1	1	1	2	E-2209008	Adapter for Steam hose for steam cylinders CY45 and CY45/2
	1							E-3221004	Clip for adapter
2		1	1	1	1	1	2	E-2209002	Clip for adapter
	1							AC-01-00000	O-ringset (Pos. 3, 17, 31, 33, 34, 35, 36, 38)
		1						AC-03-00000	O-ringset (Pos. 3, 17, 31, 33, 34, 35, 36, 38)
			1	1				AC-04-00000	O-ringset (Pos. 3, 17, 31, 33, 34, 35, 36, 38)
					1			AC-04-00100	O-ringset (Pos. 3, 17, 31, 33, 34, 35, 36, 38)
						1	1	AC-06-00000	O-ring set (Pos. 3, 17, 31, 33, 34, 35, 36, 38) for cylinders until 10/2018
						1	1	AC-06-00002	O-ring set (Pos. 3, 17, 31, 33, 34, 35, 36, 38) for cylinder CY45/2 from 11/2018
Water feed									
25	1	1						WF-03-00010	Solenoid valve, SL 1,1l/min, 220-240V, 0,2 - 10bar, with
25			1	1	1			WF-04-00010	Solenoid valve, SL 2,3l/min, 220-240V, 0,2 - 10bar, with
25						1	1	WF-06-00010	Solenoid valve, SL 3,4l/min, 220-240V, 0,2 - 10bar, with
20	0.9	0.9	1.6	1.6	1.6	1.6	1.6	E-2604002	Connecting hose solenoid valve - cylinder base [m]
23	1	1	1	1	1	1	1	E-2304080	Bush for earthing
58	1	1	1	1	1	1	1	E-2604094	Double check valve
22	6	6	6	6	6	6	6	E-8501064	Hose clamp 12-22mm
56	1	1	1	1	1	1	1	B-2304031	Hose for water connection, 0,6m, 3/4" cap nuts on both sides
Water drain									
	1	1						B-2425005	Pump-drain-hose-system (Pos. 6, 14, 15, 30, 31)
			1	1	1	1	1	B-2425009	Pump-drain-hose-system (Pos. 6, 14, 15, 30, 31)
32	1	1	1	1	1	1	1	B-2404027	Drain pump without mounting set, with 2 o-rings
42	1	1	1	1	1	1	1	B-2424014	Mounting set for drain pump

*	SLE02	SLE05 SLE10	SLE15	SLE20	SLE30	SLE45	SLE65	Article No.	Description
									Electronic standard voltage (SLExx-AA10, SLE02-MA10)
	1							E-2510000	Main contactor 20A
		1	1	1				E-2510010	Main contactor 25A
					1	2		E-2510020	Main contactor 32A
							2	E-2510030	Main contactor 50A
	1	1	1	1	1	1	1	CN-07-00000	Mainboard incl. plug
	1	1	1	1	1	1	1	CN-07-00001	Display
	2	2	2	2	2	2	2	E-0510012	Clip for display
	1	1	1	1	1	1	1	E-2502412	Control switch, double pole, middle position = "0"
4	1	1						WR-03-00001	Connecting cables for electrodes and sensor electrode with plugs
4			1	1				WR-04-00001	Connecting cables for electrodes and sensor electrode with plugs
4					1			WR-04-00101	Connecting cables for electrodes and sensor electrode with plugs
4						1		WR-06-00001	Connecting cables for electrodes and sensor electrode with plugs
							1	WR-06-00101	Connecting cables for electrodes and sensor electrode with plugs
									Accessories
70	x	x	x					E-2604012	Steam hose DN25, per m
70				x	x	x	x	E-2604013	Steam hose DN40, per m
57	x	x	x	x	x	x	x	E-2420423	Drain hose 1 1/4", per m
		x	x	x	x	x	x	E-2604002	Condensate hose DN12, per m
	x	x	x					E-2404004	Steam hose clamp DN25
				x	x	x	x	E-2604016	Steam hose clamp DN40
	x	x	x	x	x	x	x	E-2404010	Clamp for drain hose 1 1/4"
		x	x	x	x	x	x	E-8501064	Condensate hose clamp
	x	x	x					E-2604042	Connectors for steam distribution T-piece DN25, stainless steel
				x	x	x	x	E-2604023	Connectors for steam distribution T-piece DN40, stainless steel
		x	x	x	x	x	x	E-2604021	Connectors for condensate T-piece DN12

For ordering spare parts, a template can be found on the www.hygromatik.com website under the „Contact“ tab. Your spare parts order may as well be directed per e-mail to the HygroMatik main office using the address hy@hygromatik.de.

Please make sure to specify your unit model and serial number.

This page intentionally left blank

15. Technical specifications

Technical Specifications StandardLine Electrodes										
Unit type	SLE02	SLE05	SLE10	SLE15	SLE20	SLE30	SLE45	SLE65		
Steam output [kg/h]	1.9-2.1	4.8-5.2	9.5-10.4	14.3-15.6	19.0-20.7	28.5-31.2	42.7-46.8	62.0-67.5		
Electrical supply ⁽¹⁾	220-240 V/1~/50-60 Hz 380-415 V/3~/50-60 Hz									
Power rating [kW]	1.4-1.6	3.6-3.9	7.1-7.8	10.7-11.7	14.3-15.5	21.4-23.4	32.0-35.1	46.3-50.6		
Nominal current [A]	6,5	5,4	10,8	16,3	21,7	32,5	48,8	70,4		
Circuit Protection [A] ⁽²⁾	1 x 10	3 x 10	3 x 16	3 x 20	3 x 35	3 x 40	3 x 63	3 x 80		
Number of steam cylinder	1									
Control	StandardLine-mainboard with capacitive touch display									
Separate control voltage ⁽³⁾	220-240 V /N /1,6 A									
Steam hose connection [mm]	1 x 25			1 x 40			2 x 40			
Empty weight [kg]	9,0	12,0	20,0							
Max. filling volume [l]	3,0	5,0	13,0							
Operation weight [kg]	12,0	17,0	34,0							
Width ⁽⁴⁾ [mm]	350			425			590			
Height ⁽⁴⁾ [mm]	375			535			790			
Depth ⁽⁴⁾ [mm]	245			320			415			
Water connection	Water / tap water (different qualities); 1 to 10bar, with 3/4" connection for external thread									
Drain water connection	Connection Ø 1 1/4"									

⁽¹⁾ Other voltages upon request.

⁽²⁾ Multiply power input by 1.1 after full blow-down. Note overload capacity of automatic breakers. If necessary, select the next higher rating.

⁽³⁾ Internal control voltage upon request.

⁽⁴⁾ Outer dimensions of width and depth. Height incl. drain connection.

16. Exploded view

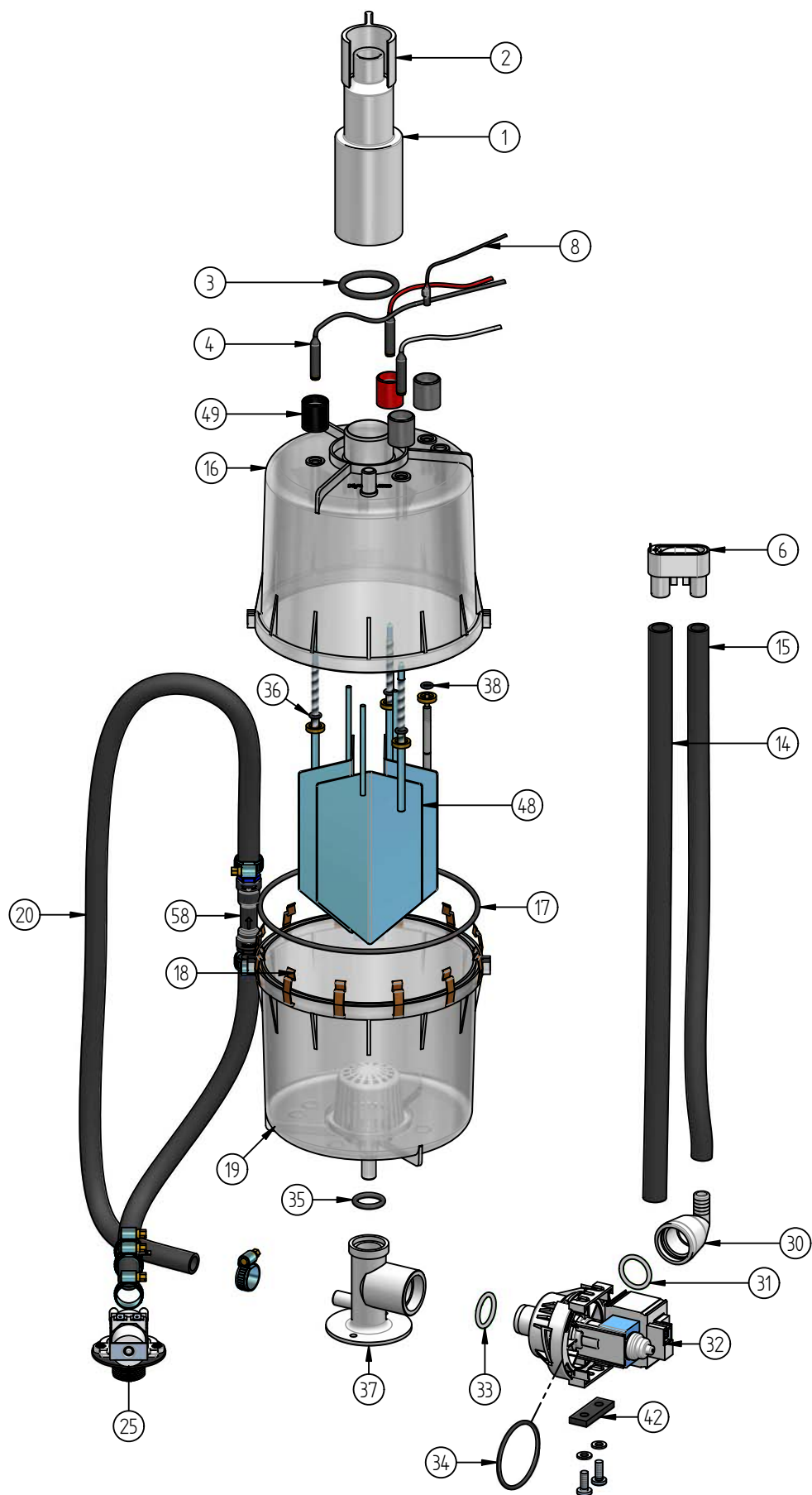

17. View of housing

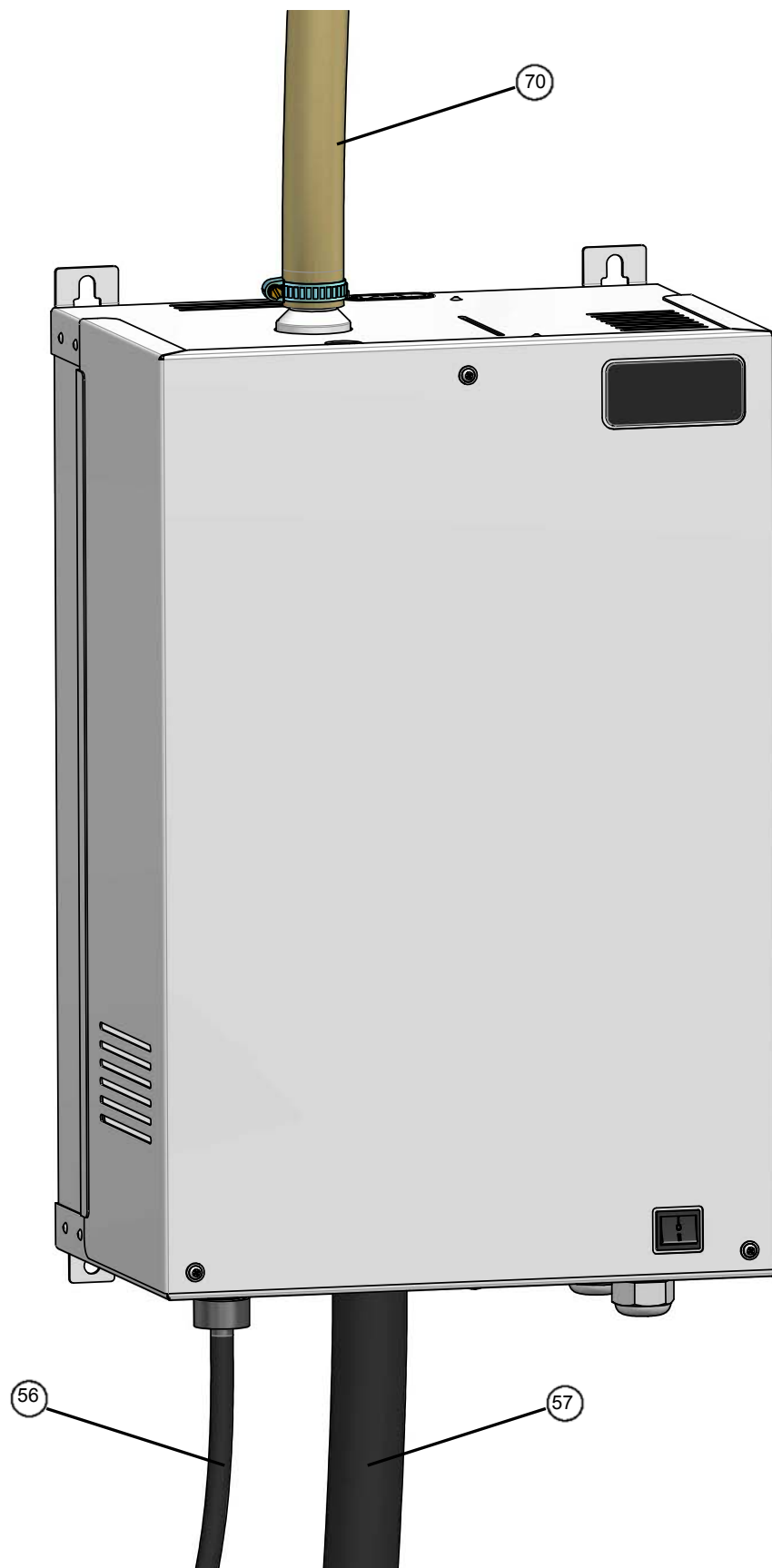

HYGROMATIK[®]

Lise-Meitner-Str.3 • D-24558 Henstedt-Ulzburg
Phone +49(0)4193/ 895-0 • Fax -33
eMail hy@hygromatik.de • www.hygromatik.com
A member of the **spirax/sarco** Group