

USER'S MANUAL

MICRA 100
MICRA 100 ERV
MICRA 100 E
MICRA 100 E ERV



Air handling unit

CONTENTS

Safety requirements.....	2
PURPOSE.....	4
Delivery set.....	4
Designation key.....	4
Technical data.....	5
Unit design and operating principle.....	6
Installation and set-up.....	7
Connection to power mains.....	11
Unit control.....	12
Technical maintenance.....	16
Troubleshooting.....	17
Storage and transportation regulations.....	17
Manufacturer's warranty.....	18
Certificate of acceptance.....	19
Seller information.....	19
Installation certificate.....	19
Warranty card.....	19

This user's manual is a main operating document intended for technical, maintenance, and operating staff.

The manual contains information about purpose, technical details, operating principle, design, and installation of the MICRA 100 unit and all its modifications.

Technical and maintenance staff must have theoretical and practical training in the field of ventilation systems and should be able to work in accordance with workplace safety rules as well as construction norms and standards applicable in the territory of the country.

The information in this user's manual is correct at the time of the document's preparation.

The Company reserves the right to modify the technical characteristics, design, or configuration of its products at any time in order to incorporate the latest technological developments.

No part of this publication may be reproduced, stored in a retrieval system, or transmitted, in any form or by any means in any information search system or translated into any language in any form without the prior written permission of the Company.

SAFETY REQUIREMENTS

- Please read the user's manual carefully prior to installing and operating the unit.
- All user's manual requirements as well as the provisions of all the applicable local and national construction, electrical, and technical norms and standards must be observed when installing and operating the unit.
- The warnings contained in the user's manual must be considered most seriously since they contain vital personal safety information.
- Failure to follow the rules and safety precautions noted in this user's manual may result in an injury or unit damage.
- After a careful reading of the manual, keep it for the entire service life of the unit.
- While transferring the unit control, the user's manual must be turned over to the receiving operator.

UNIT INSTALLATION AND OPERATION SAFETY PRECAUTIONS



- Disconnect the unit from power mains prior to any installation operations.



- Unpack the unit with care.



- The unit must be grounded!



- While installing the unit, follow the safety regulations specific to the use of electric tools.



- Do not change the power cable length at your own discretion.
- Do not bend the power cable.
- Avoid damaging the power cable.
- Do not put any foreign objects on the power cable.

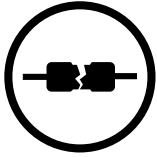

- Do not use damaged equipment or cables when connecting the unit to power mains.



- Do not touch the unit controls with wet hands.
- Do not carry out the installation and maintenance operations with wet hands.



- Do not allow children to operate the unit.



- Do not store any explosive or highly flammable substances in close proximity to the unit.

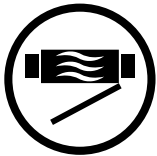

- Do not open the unit during operation.



- Do not block the air duct when the unit is switched on.

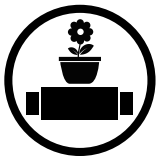

- Do not sit on the unit and avoid placing foreign objects on it.



- Do not lay the power cable of the unit in close proximity to heating equipment.

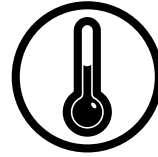

- Do not operate the unit outside the temperature range stated in the user's manual.
- Do not operate the unit in aggressive or explosive environments.



- Do not wash the unit with water.
- Protect the electric parts of the unit against ingress of water.

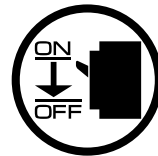

- Disconnect the unit from power mains prior to any technical maintenance.



- When the unit generates unusual sounds, odour, or emits smoke, disconnect it from power supply and contact the Seller.



- Do not direct the air flow produced by the unit towards open flame or ignition sources.



- In case of continuous operation of the unit, periodically check the security of mounting.

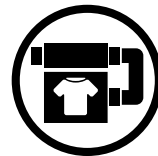

- Use the unit only for its intended purpose.



**THE PRODUCT MUST BE DISPOSED SEPARATELY AT THE END OF ITS SERVICE LIFE.
DO NOT DISPOSE THE UNIT AS UNSORTED DOMESTIC WASTE.**

PURPOSE

The unit is designed to ensure continuous mechanical air exchange in houses, offices, hotels, cafes, conference halls, and other utility and public spaces as well as to recover the heat energy contained in the air extracted from the premises to warm up the filtered stream of intake air.

The unit is not intended for organizing ventilation in swimming pools, saunas, greenhouses, summer gardens, and other spaces with high humidity.

Due to the ability to save heating energy by means of energy recovery, the unit is an important element of energy-efficient premises.

The unit is a component part and is not designed for stand-alone operation. It is rated for continuous operation.

Transported air must not contain any flammable or explosive mixtures, evaporation of chemicals, sticky substances, fibrous materials, coarse dust, soot and oil particles or environments favourable for the formation of hazardous substances (toxic substances, dust, pathogenic germs).



THE UNIT SHOULD NOT BE OPERATED BY CHILDREN OR PERSONS WITH REDUCED PHYSICAL, MENTAL, OR SENSORY CAPACITIES, OR THOSE WITHOUT THE APPROPRIATE TRAINING.

THE UNIT MUST BE INSTALLED AND CONNECTED ONLY BY PROPERLY QUALIFIED PERSONNEL AFTER THE APPROPRIATE BRIEFING.

THE CHOICE OF UNIT INSTALLATION LOCATION MUST PREVENT UNAUTHORIZED ACCESS BY UNATTENDED CHILDREN.

DELIVERY SET

NAME	NUMBER
Air handling unit	1 pc.
User's manual	1 pc.
Mounting template	1 pc.
Fastening kit	1 pc.
Magnetic sheet	1 pc.
Key	1 pc.
Flange for additional extract spigot	1 pc.
Packing box	1 pc.

DESIGNATION KEY

Designation example **MICRA 100 E ERV**

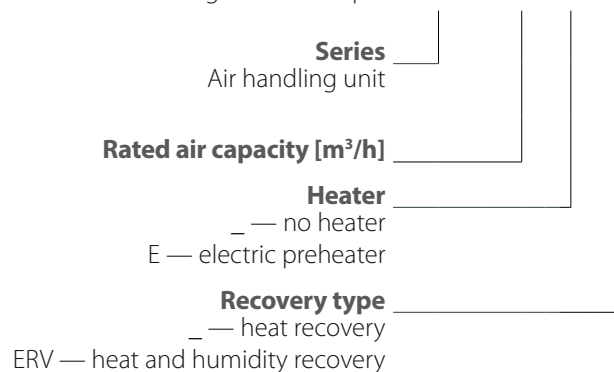

TECHNICAL DATA

The unit is designed for application with the ambient temperature ranging from +1 °C to +40 °C and relative humidity up to 80 %. In order to prevent condensation on the internal walls of the unit, it is necessary that the surface temperature of the casing is 2-3 °C above the dew point temperature of the transported air.

The unit is rated as a Class I electrical appliance.

Hazardous parts access and water ingress protection rating:

- IP22 for the unit connected to the air ducts;
- IP44 for the unit motors.

The unit design is constantly being improved, thus some models may be slightly different from those described in this manual.



THE EXTRACT AIR TEMPERATURE SHOULD BE NO HIGHER THAN +40 °C AND RELATIVE HUMIDITY SHOULD NOT EXCEED 70 % OVER THE ENTIRE TEMPERATURE RANGE.

Parameters	MICRA 100			MICRA 100 ERV			MICRA 100 E			MICRA 100 E ERV		
	1	2	3	1	2	3	1	2	3	1	2	3
Speed												
Unit voltage [V/50 (60) Hz]	1~110-240			1~110-240			1~230			1~230		
Maximum fan power [W]	12	21	45	12	21	45	12	21	45	12	21	45
Preheater power [W]	-			-			700			700		
Maximum unit current (without a heater) [A]	0.4			0.4			0.4			0.4		
Maximum unit current (with a heater) [A]	-			-			3.6			3.6		
Maximum air capacity [m³/h]	30	60	100	30	60	100	30	60	100	30	60	100
Sound pressure level at 3 m distance [dBA]	13	27	39	13	27	39	13	27	39	13	27	39
Transported air temperature [°C]	-20...+40			-20...+40			-20...+40			-20...+40		
Casing material	Painted steel			Painted steel			Painted steel			Painted steel		
Insulation [mm]	10			10			10			10		
Extract filter	G4			G4			G4			G4		
Supply filter	G4, F8 (Optional: F8 C, H13)			G4, F8 (Optional: F8 C, H13)			G4, F8 (Optional: F8 C, H13)			G4, F8 (Optional: F8 C, H13)		
Connected air duct diameter [mm]	100			100			100			100		
Weight [kg]	31			31			31			31		
Heat recovery efficiency [%]	98	92	89	96	89	83	98	92	89	96	89	83
Heat exchanger type	Counter-flow			Counter-flow Enthalpy			Counter-flow			Counter-flow Enthalpy		

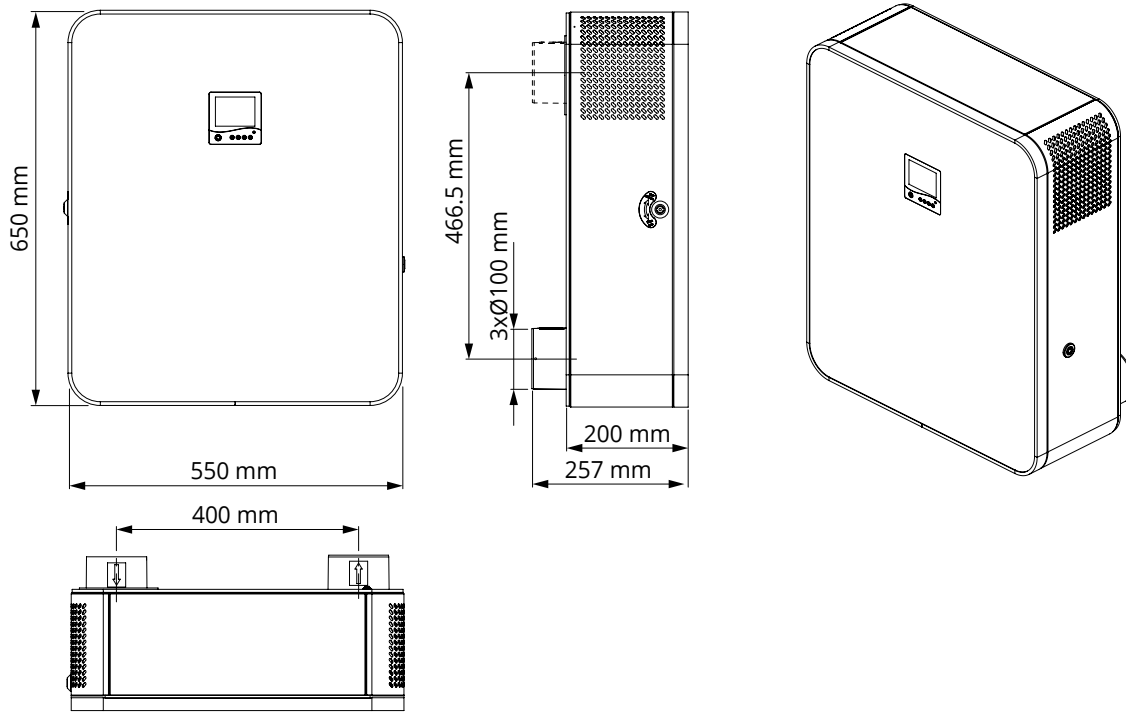

UNIT DESIGN AND OPERATING PRINCIPLE

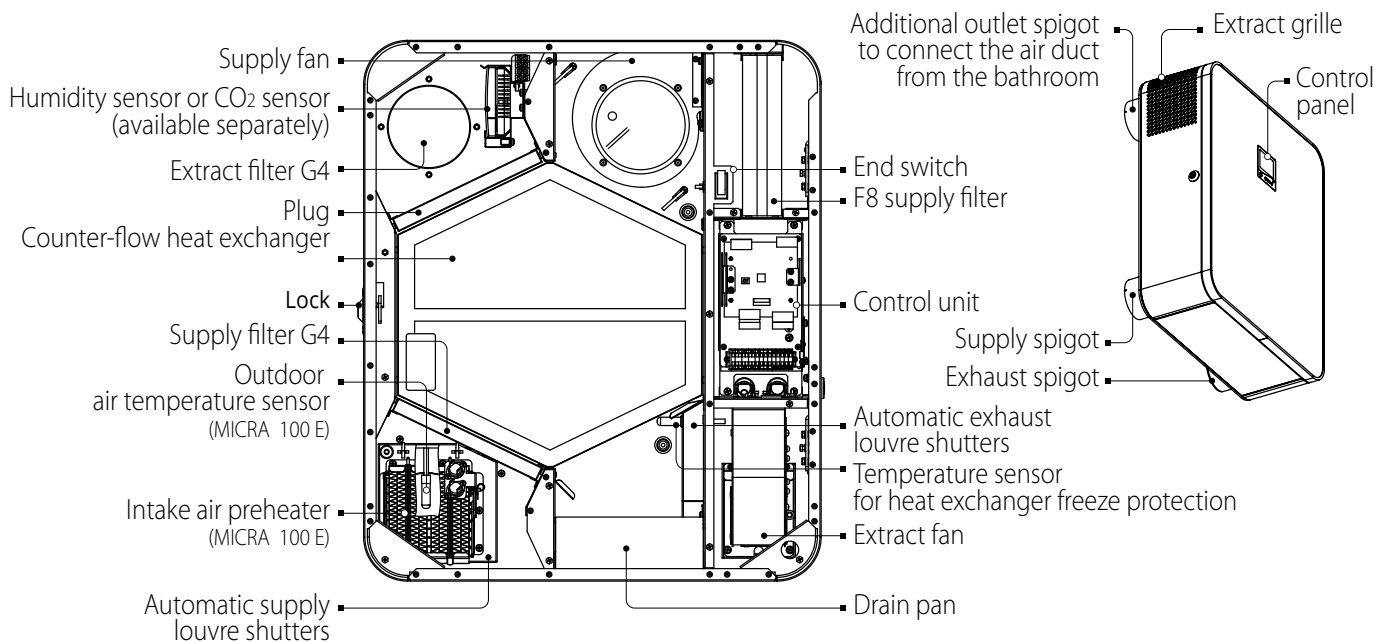

- Warm stale extract air from the room flows to the unit, where it is filtered by the extract filter, then air flows through the heat exchanger and is exhausted outside by the extract fan. Cold fresh air from outside flows into the unit, where it is cleaned by the supply filter. Then filtered air flows through the heat exchanger and is moved to the room with the supply fan. Thermal energy of warm extract air is transferred to clean intake fresh air from outside and warms it up. The air flows are fully separated. Heat recovery minimizes heat losses, which reduces the cost of space heating in the cold season.
- The MICRA 100 E units are equipped with a supply air preheater with automatic overheating protection. The preheater is located upstream of the heat exchanger and is designed for its freeze protection. When the intake air temperature is below -3 °C, the preheater automatically warms up intake air so the average exhaust air temperature downstream of the heat exchanger is not below +5 °C. The preheater is switched on and off automatically by the temperature sensor.
- The heat exchanger freeze protection in the MICRA 100 models without a preheater is achieved by automatic supply fan speed reduction according to extract air sensor readings. The extract fan runs at maximum speed.

- Temperature differences between supply and extract air flows in the units with polystyrene heat exchangers lead to condensate formation. Condensate is collected in the drain pan and is removed outside by the drain pipes through the exhaust air duct. Condensate is not formed in the units equipped with an enthalpy heat exchanger as moisture is transferred from one air flow to another through the membrane.
- The louvre shutters open automatically when the motors are switched on and close when the motors are switched off.
- An additional outlet spigot can be fitted to the unit to connect the exhaust air duct from additional premises, e.g. a bathroom.

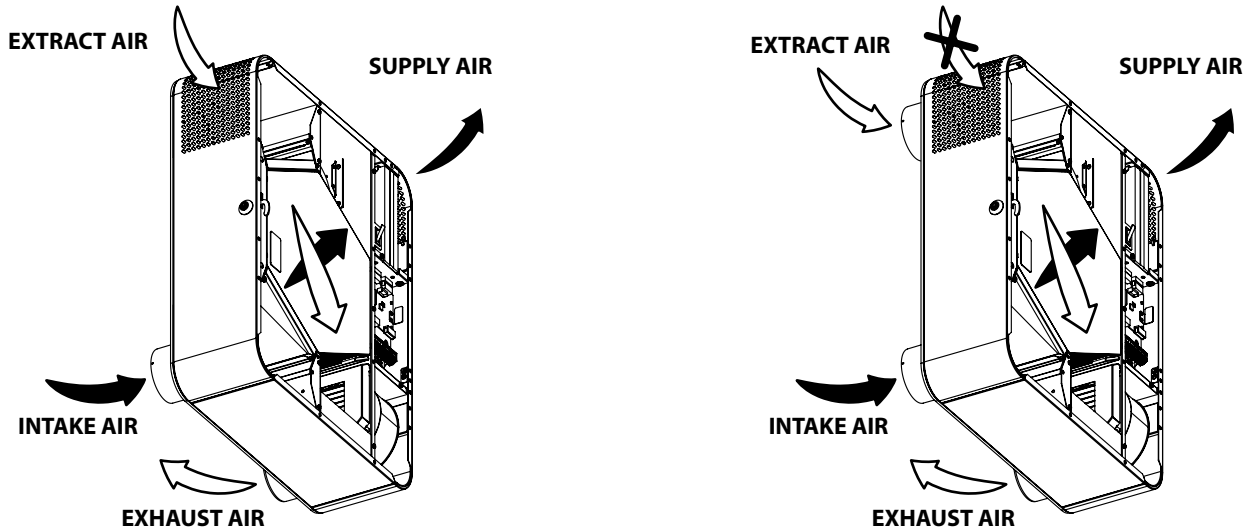

INSTALLATION AND SET-UP



READ THE USER'S MANUAL BEFORE INSTALLING THE UNIT.



WHILE INSTALLING THE UNIT ENSURE CONVENIENT ACCESS FOR SUBSEQUENT MAINTENANCE AND REPAIR.

Minimum distances from the unit to the surfaces

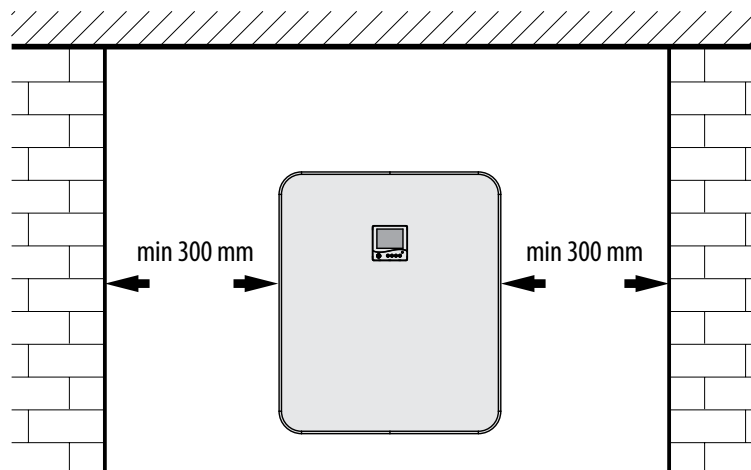

Mounting template

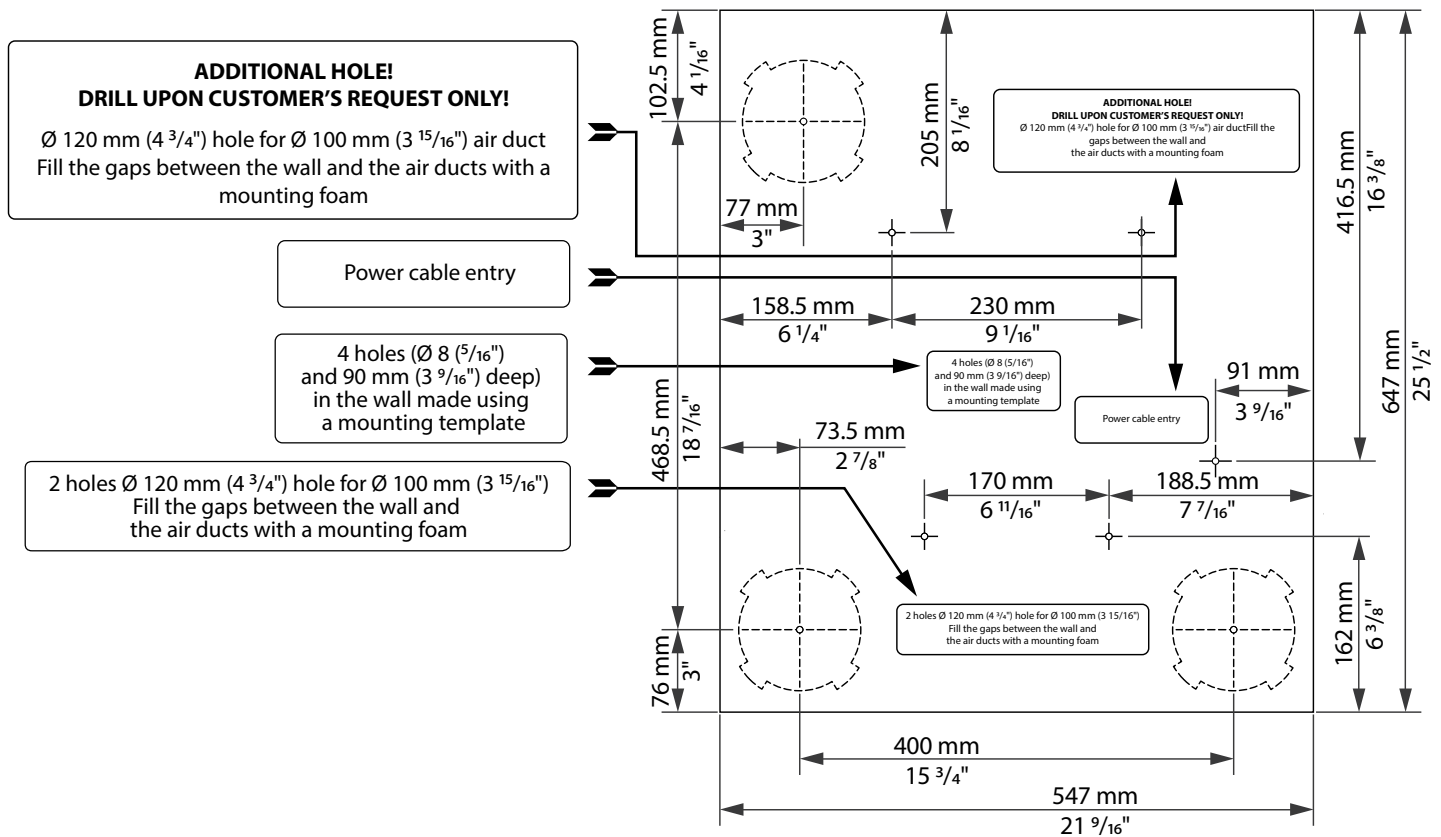

Unit mounting

BEFORE MOUNTING MAKE SURE THE CASING DOES NOT CONTAIN ANY FOREIGN OBJECTS (E.G. FOIL, PAPER).

THE UNIT MUST BE MOUNTED ON A PLANE SURFACE. MOUNTING OF THE UNIT TO AN UNEVEN SURFACE CAN LEAD TO THE UNIT CASING DISTORTION AND OPERATION DISTURBANCE.

1. Mark and drill holes in the wall using a mounting template. Fix the mounting template on the wall with a self-adhesive tape at the required level. Using a mounting template make marks to drill holes for air ducts, for unit mounting and for power cable entry. Before installation operations route necessary cables and wires to the unit mounting place.

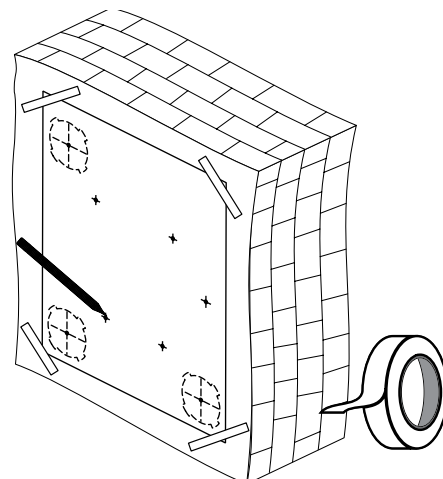

2.1. Remove the mounting template and drill two through holes \varnothing 120 mm for round air ducts.

When mounting the unit with an additional extract spigot prepare a hole in the wall for a connecting bend and for laying of a rectangular air duct.

A connecting bend, rectangular and round air ducts are available separately.

Round air ducts are included in the delivery set of the ventilation hood.

Drill holes (\varnothing 8 mm, 90 mm deep) to mount the unit. Install the expansion anchors, remove the perforated fillers for the air ducts from the mounting template and install the mounting template back using a self-adhesive tape.

2.2. Cut air ducts of required length. Note that the telescopic air duct end must protrude for the distance that enables installation of the outer ventilation hood. For details, refer to the installation instruction for the ventilation hood.

The outer ventilation hood is available separately.

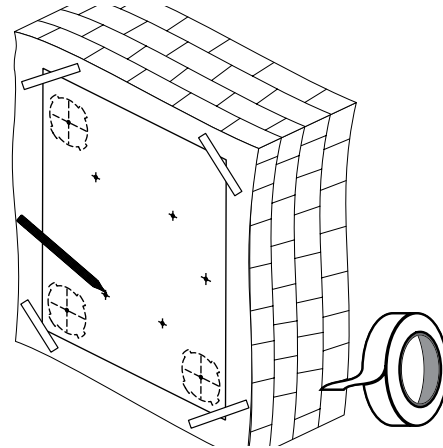

3. Fix the mounting template on the wall to install the air ducts. Insert the air ducts in the corresponding holes of the mounting template. Install the air duct with the minimum slope of 3 mm for condensate removal.

To install the unit with an additional spigot, insert the connecting bend into the prepared hole in the wall, aligning the mounting template hole with a round end of the connecting bend.

Connect a rectangular duct to the connecting bend.

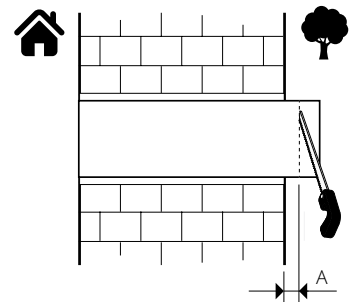
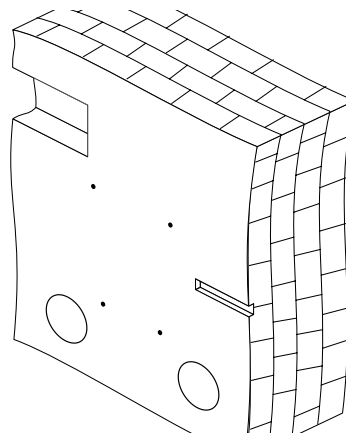

4. Fill the spaces between the air ducts and the wall with a mounting foam through the specially designed holes in the mounting template. Wait till a mounting foam hardens then take off the mounting template and remove the foam excess. Cut off the protruding air duct parts to be flush with the wall surface.

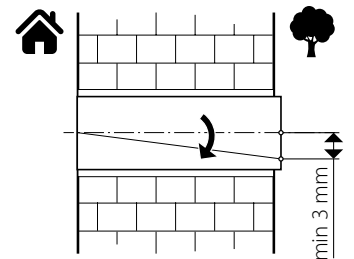
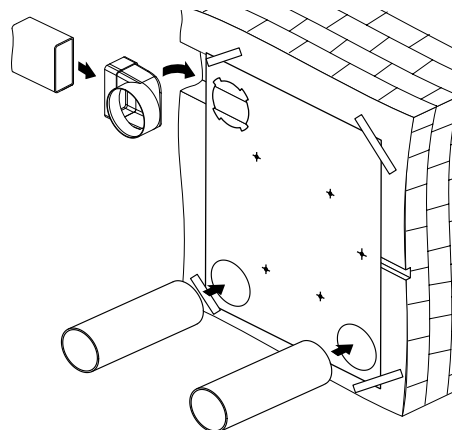

5. To install an additional extract spigot, remove the plug on the rear part of the unit. Undo the screws, remove the plug and fix a flange in its place using screws.

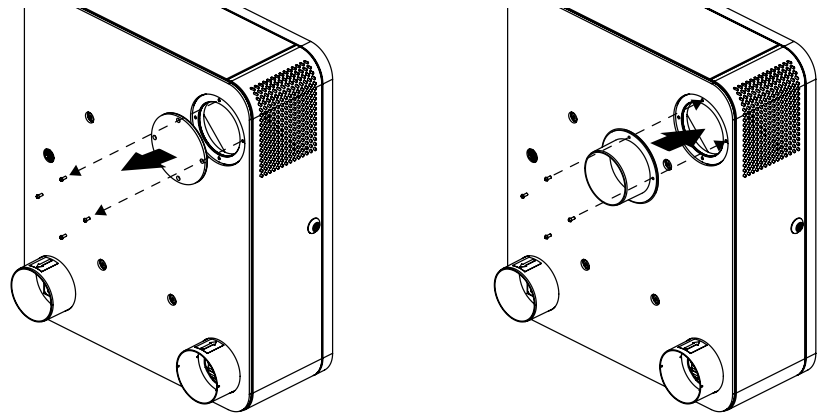

6. CAUTION!

Install the condensate preheater before fixing the unit to the wall (see the User's manual of the electric heater).

Insert the connecting cables of the heater, external humidity sensor or CO₂ sensor into the control unit through the corresponding holes on the back wall of the unit.

- Open the unit.
- Undo the screws securing the shield plate and remove it.
- Remove the heat exchanger.
- Lift the unit and insert the spigots into the corresponding air ducts installed in the wall.

CAUTION!

Remove the magnetic plug from the extract grille if an additional outlet spigot is not installed.

- Fix the unit on the wall using the supplied screws and dowels.
- Install the heat exchanger back to the unit.
- Install the humidity or CO₂ sensor (available separately) on the bracket.
- Make electrical connections, see "Connection to power mains".
- Reassemble the unit in the reverse order.

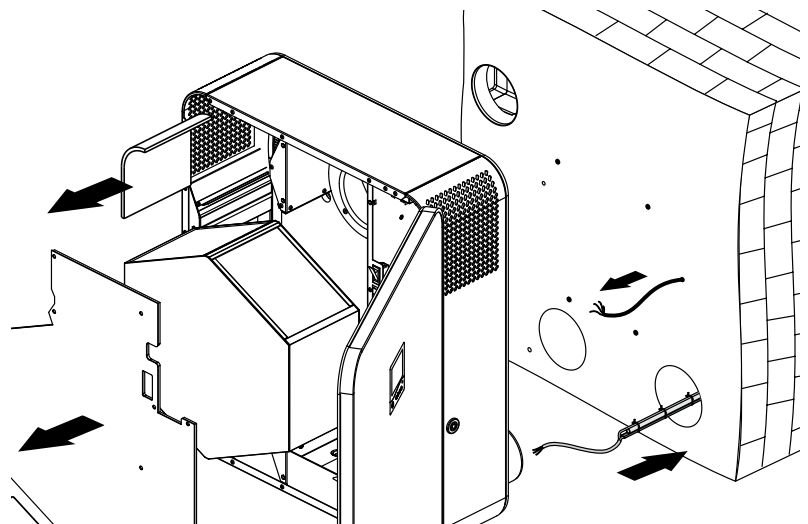

7. Fix the unit on the wall using the supplied screws and expansion anchors.

Install the heat exchanger back and close the unit door. Cut a part of the drain pipe protruding outside to a length not more than 10 mm.

Fix the outer hood on the outer wall of the building (see the ventilation hood installation manual).

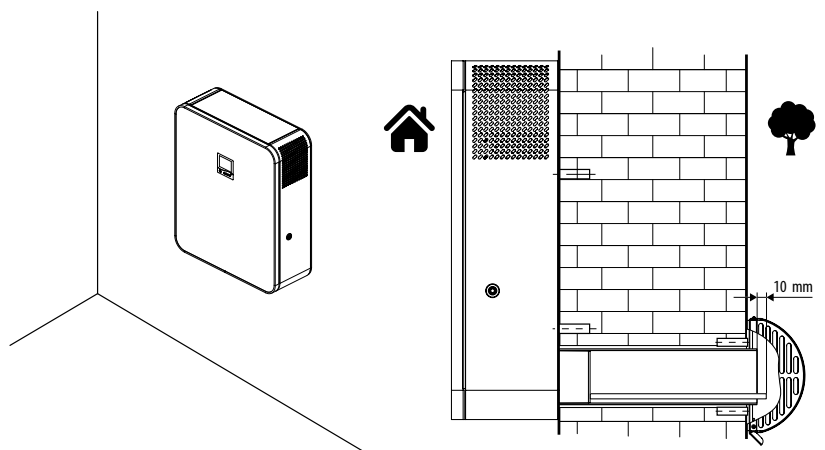

CONNECTION TO POWER MAINS



**POWER OFF THE POWER SUPPLY PRIOR TO ANY OPERATIONS WITH THE UNIT.
THE UNIT MUST BE CONNECTED TO POWER SUPPLY BY A QUALIFIED ELECTRICIAN.
THE RATED ELECTRICAL PARAMETERS OF THE UNIT ARE GIVEN ON THE
MANUFACTURER'S LABEL.**

CONNECTION OF ADDITIONAL EXTERNAL CONTROLS

- The unit is rated for connection to 1~230 V/50 (60) Hz power mains.
- The unit must be connected to power mains using insulated electric conductors (cables, wires). The actual wire cross section selection must be based on the maximum load current, maximum conductor temperature depending on the wire type, insulation, length and installation method.
- The external power input must be equipped with an automatic circuit breaker built into the stationary wiring to open the electric circuit in case of overload or short-circuit. The circuit breaker installation place must provide quick access for emergency shutdown of the unit. The trip current of the automatic circuit breaker **QF** must exceed the maximum current consumption of the unit (refer to the technical data table). The recommended trip current of the circuit breaker is the next current in the standard trip current row following the maximum current of the connected unit. The automatic circuit breaker is not included in the delivery set.

Wiring diagram of the additional controls in the control unit

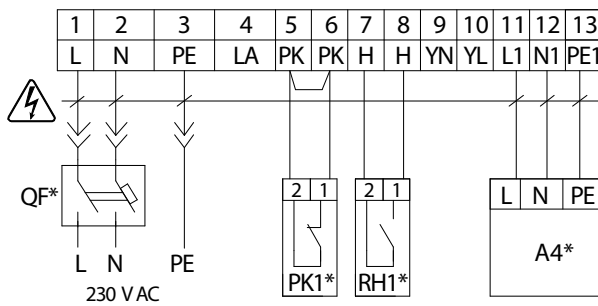

Connection of additional external control contacts is implemented in the control unit. For accessing the control unit open the unit door, release the screws fixing the shielding and remove it.

Wiring diagram of the CO₂ sensor inside the unit

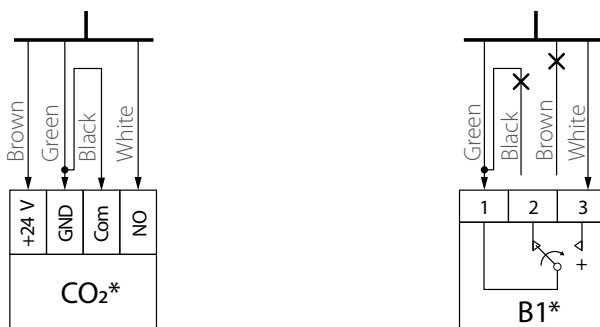

Connecting humidity sensor or CO₂ sensor to the control unit via a cable, which is attached to the bracket.

Designation	Unit name	Note
RH1*	Connecting contact humidity or CO ₂ sensor in the control unit	
B1* or CO₂*	Connecting contact humidity or CO ₂ sensor via cable	
A4*	Heating element for condensate heating	
PK1*	Contact from fire alarm panel	Remove the jumper during installation
QF*	Automatic circuit breaker	

*Additionally connected devices are purchased separately.

UNIT CONTROL

The unit is controlled by means of the control panel on the unit casing and of the remote control.

Wall-mounted control panel

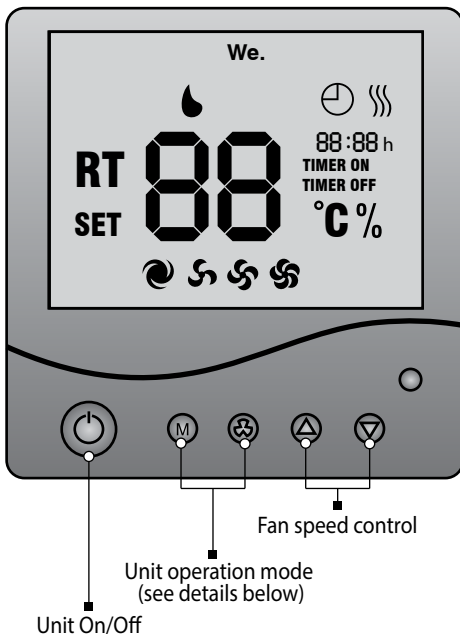

Remote control

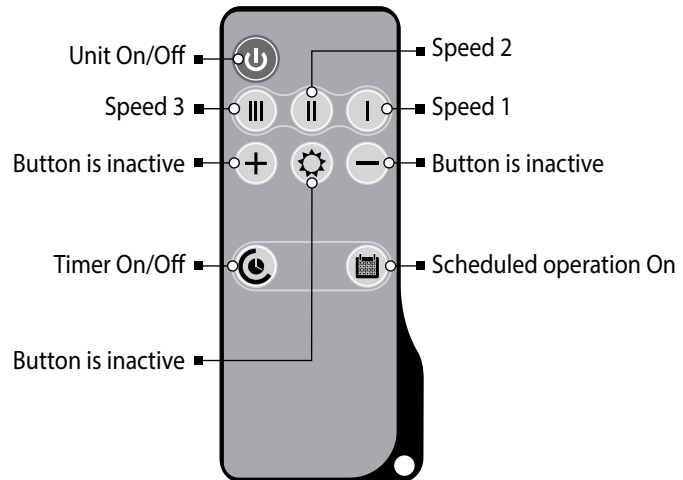

1. Unit On/Off.

Unit activation/deactivation:

- by means of the Unit On/Off button from the control panel
- by means of the Unit On/Off button from the remote control.

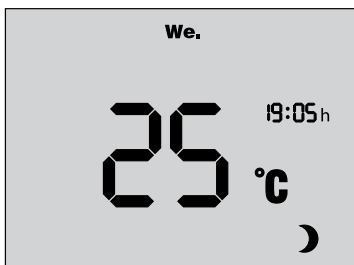

When the unit is off, the control panel display indicates:

- Room temperature
- Day of the week
- Time
- Off mode indication
- The **TIMER ON** and indicators glow in the Heater Cooling mode. Synchronously the heater cooling countdown is displayed in min: sec.



When the unit is switched on, the control panel display indicates:

- Room temperature
- Day of the week
- Time
- Fan speed status
- Timer status
- The indicator **TIMER ON** lights up when the timer is on
- The indicator **TIMER OFF** lights up when the timer is off
- Heater status information. The indicator lights up when the heater is on

2. Control of operating modes.

Fan speed control:

- From the control panel: press to increase the speed or to decrease it (speed 1 - speed 2 - speed 3).
- From the remote control: press to set speed 1 to set speed 2 and to set speed 3.





The control panel displays the current fan speed:

- indicator – speed 1
- indicator – speed 2
- indicator – speed 3

3. Timer.

The timer is designed to switch the fans to maximum speed with subsequent automatic reset to a previous speed after a set time period, from 20 to 60 minutes.

To turn the timer on/off:

- From the control panel: press and hold , then press . Press the button once to set the timer for 20 minutes, each subsequent pressing extends the timer setting for 10 minutes. The maximum timer setting is 60 minutes. Press and hold  for 3 seconds to turn the timer off.
- From the remote control: press  to turn the timer on for 20 minutes. To turn the timer off, switch off the unit by pressing .

4. Freeze protection of the heat exchanger.

Unit without a heater	Unit with a preheater
If the exhaust air temperature downstream of the heat exchanger is below +5 °C (factory setting), the supply fan runs 25 % of the maximum speed and the extract fan runs at maximum speed. When the temperature exceeds +5 °C, the unit reverts to the previous operating mode.	When the intake air temperature is below -3 °C, the heater automatically warms up intake air so the average exhaust air temperature downstream of the heat exchanger is not below +5 °C.

WARNING! IF THE HEATER WAS ON DURING THE UNIT SHUTDOWN, THE FANS CONTINUE RUNNING TO COOL DOWN THE HEATER. THE INDICATOR  LIGHTS UP. THE SHUTDOWN TIME OF THE FANS IS 0.5-2 MINUTES DEPENDING ON THE UNIT MODEL.

5. Unit parameter settings.











WARNING!
CHANGING THE UNIT SETTINGS RESULTS IN LOSS OF THE FACTORY SETTINGS!
FAN SPEED ADJUSTMENT IS POSSIBLE ONLY FROM THE CONTROL PANEL!







Fan Speed Setting mode.

During the unit setup the capacity of Speed 1, Speed 2 and Speed 3 can be continuously adjusted. To enter the Fan Capacity Adjustment mode, turn the unit off. Then press and hold  on the control panel and hold  pressed for 3 seconds.



Access to the Fan Capacity Adjustment mode is confirmed by the **SET** and **%** indicators on the control panel display.

- To select the required speed to be adjusted, use  and . When selecting the adjustable speed the selected speed is displayed by the indications ,  or .
- To adjust the supply fan capacity, press and hold  and then press  to set the fan speed up or  to set it down. Each pressing of  and  increases or reduces the supply fan speed by 1 %. If  is pressed, the display indicators show the current supply fan speed.

- To adjust the extract fan capacity, press and hold . While holding  adjust the speed by pressing  for setting speed up and  for setting speed down. Each pressing of  and  increases or reduces the extract fan speed by 1 %. If  is pressed, the display indicators show the current extract fan speed.

To exit the Fan Speed Setting mode and save the changes, press .

Fan speed adjustment is not possible with the remote control.

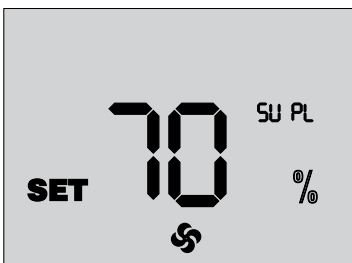

To restore factory settings, enter the Fan Speed Setting mode, synchronously press and hold  and  for 3 seconds.

Fan speed factory settings:

- speed 1 – 30 %
- speed 2 – 60 %
- speed 3 – 100 %

6. Viewing the temperature sensor readings.

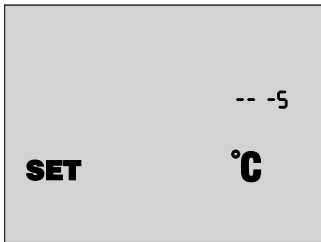

To enter the Sensor Readings View mode, turn the unit off. Then press  and  on the control panel simultaneously and hold them down at least for 3 seconds.

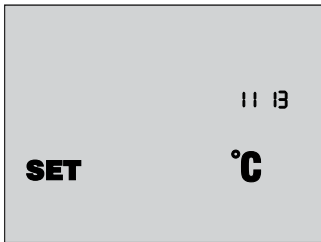

The indicators **SET** and **°C** light up in the Sensor Readings View mode.

- To view the current temperature sensor readings, press and hold .







- Press  to view the controller board model code and software version code on the control panel display.
- To exit the Sensor Adjustment mode, press .

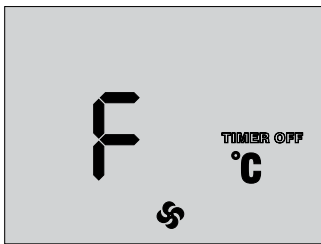







7. Filter replacement indication.

On the expiry of filter service life (3 000 hours) the operating mode temperature normally shown on the control panel display is replaced by **F** indicating the need to replace the filters.







- When the filter replacement indicator **F** is active, switch off the unit by pressing  and disconnect it from power supply. Then replace the filters (see the sequence in the «Technical Maintenance» section).
- Then switch on the unit by pressing  on the control panel or  on the remote control. Then press  and  simultaneously to reset the hour meter.

8. Date/time setting.

- Turn the unit off.
- To enter the Date/Time Setting mode press and hold . Then press  on the control panel.
- While holding down  select the parameter for adjustment by pressing  and . The adjusted parameter is blinking.
The date/time setting parameters are arranged in the following order:
 - Minute
 - Hour
 - Day of the week
 - Date
 - Month
 - Year
- Set the desired value of the selected parameter by pressing  and  on the control panel.
- To exit Date/Time Setting mode, press .

9. Scheduled Operation mode.

- Press and hold then press  on the control panel to activate the Scheduled Operation mode. The indicator  lights up when the Scheduled Operation mode is activated.
- Press and hold  then press  on the control panel to deactivate the Scheduled Operation mode.
- From the remote control the Scheduled Operation mode is activated/deactivated by pressing .
- Timer control has higher priority than scheduled operation.

10. Scheduled Operation mode setting.

Each day of the week has four entries. Time of switching the unit to the set speed and turning the heater on or off can be set for each entry.

- To enter the Scheduled Operation mode settings, turn the unit off by pressing on the control panel or on the remote control.
- Press and hold on the control panel and then press .

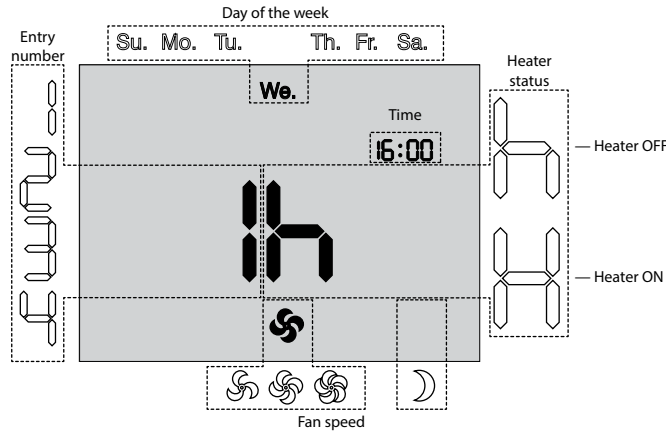

- Press and hold for selecting the scheduled operation parameters and select the desired parameter using and .
- Set the desired value by pressing and .

Scheduled operation parameters:

Entry number – each day of the week has four entries.

Day of the week – setting the day of the week.

Heater status – setting the heater status for the current entry: **H** – heater on, **h** – heater off.

Fan speed – setting the fan speed for the current entry: **S1** – speed 1, **S2** – speed 2, **S3** – speed 3, **☾** – off.

Time – setting time for the current entry.

- To copy the set entries for the next day, press and hold and press . No copying from Sunday to Monday is possible.
- Press on the control panel or on the remote control to exit the Scheduled Operation Setting mode.

Scheduled operation programming example

By default, the Scheduled Operation mode is set for the warm seasons.

When selecting this mode for the cold seasons set the heater status **H**.

Day of the week	Entry number											
	1			2			3			4		
	Start time	Mode	Heater status	Start time	Mode	Heater status	Start time	Mode	Heater status	Start time	Mode	Heater status
Mo.	07:00	speed 2	OFF	08:00	speed 1	OFF	17:00	speed 2	OFF	22:00	speed 1	OFF
Tu.	07:00	speed 2	OFF	08:00	speed 1	OFF	17:00	speed 2	OFF	22:00	speed 1	OFF
We.	07:00	speed 2	OFF	08:00	speed 1	OFF	17:00	speed 2	OFF	22:00	speed 1	OFF
Th.	07:00	speed 2	OFF	08:00	speed 1	OFF	17:00	speed 2	OFF	22:00	speed 1	OFF
Fr.	07:00	speed 2	OFF	08:00	speed 1	OFF	17:00	speed 2	OFF	22:00	speed 1	OFF
Sa.	10:00	speed 2	OFF	12:00	speed 2	OFF	17:00	speed 2	OFF	23:00	speed 1	OFF
Su.	10:00	speed 2	OFF	12:00	speed 2	OFF	17:00	speed 2	OFF	23:00	speed 1	OFF

11. Alarms.

In case of alarm, the unit is turned off and the alarm indicators are displayed on the control panel.

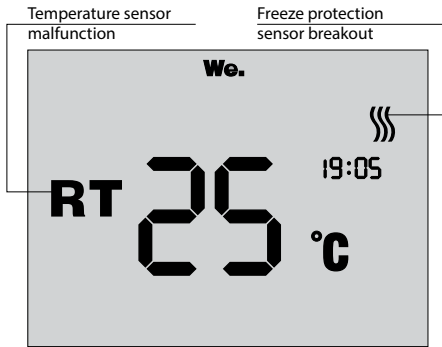

ALARM	INDICATION	TROUBLESHOOTING
Outdoor temperature sensor malfunction	RT	Contact the Seller for further information.
Freeze protection sensor breakout	RT ≡≡≡	Contact the Seller for further information.

TECHNICAL MAINTENANCE



DISCONNECT THE UNIT FROM POWER SUPPLY BEFORE ANY MAINTENANCE OPERATIONS!

Maintenance operations of the unit are required 3–4 times per year. Maintenance includes periodic dust removal from surfaces, cleaning and replacement of filters and dry cleaning of fans.

Maintenance includes general cleaning of the unit and the following operations:

1. Filter maintenance (3–4 times per year).

Dirty filters increase air resistance in the system and reduce supply air volume.

- Remove the clogged filters from the unit:
- Clean the F8 filter with a vacuum cleaner.
- To remove the G4 filters for cleaning, remove the flexible clamps fixing them and pull the filters until they slide off the guides. Clean the filters with water and let them dry. After complete drying reassemble the filters in the reverse order.
- Install the filters back to the unit.

The filters require cleaning not less than 3-4 times per year. For new filters contact the Seller.

2. Heat exchanger maintenance (once a year).

Some dust may accumulate on the heat exchanger block even in case of regular maintenance of the filters. To maintain the high heat recovery efficiency, regular cleaning is required. Periodical dry cleaning is recommended. Use a vacuum cleaner with a narrow nozzle. Remove the clogged heat exchanger out of the unit, clean it with a vacuum cleaner and install the heat exchanger back to the unit.

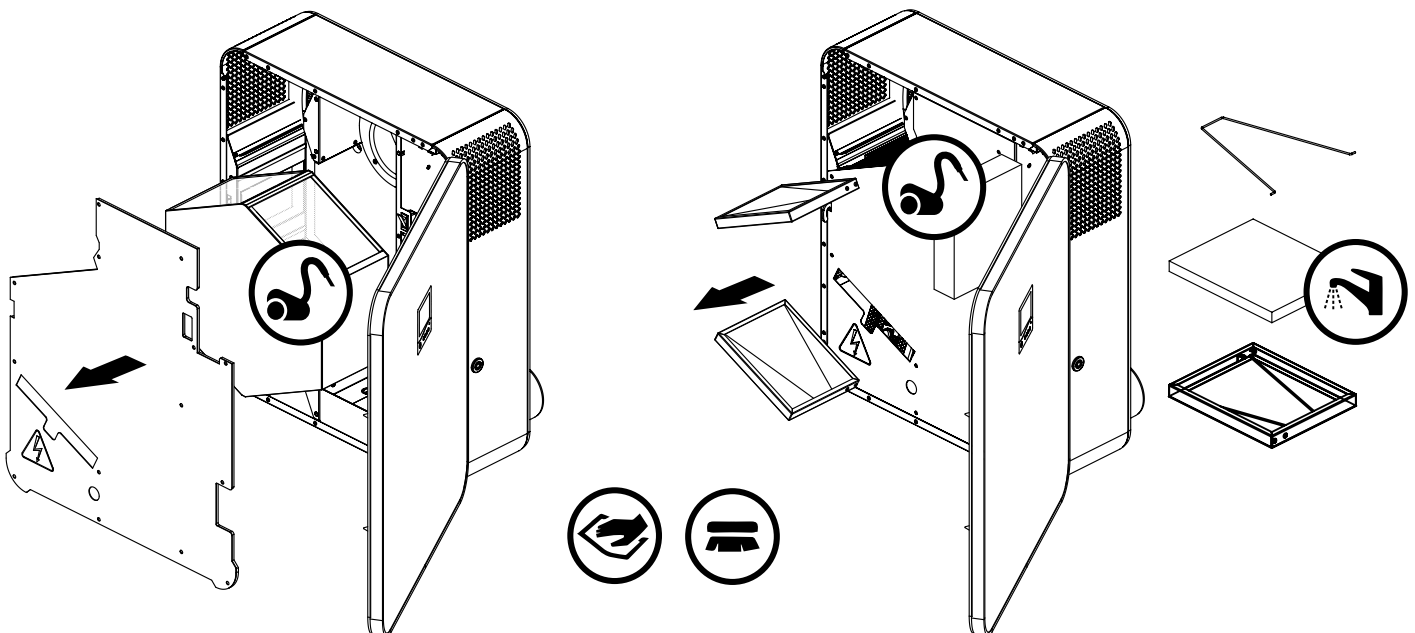

3. Fan maintenance (once a year).

Even in case of regular maintenance of the filters, some dust may accumulate inside the fans and reduce the fan performance and supply air flow. Clean the fan with a cloth or a soft brush. Do not use water, aggressive solvents or sharp objects as they may damage the impeller.

4. Technical maintenance of the supply grille (twice a year).

The supply grille may get clogged with leaves and other objects which may reduce the unit performance. Check the supply grille twice per year and clean it as required.

5. Technical maintenance of air duct system (every 5 years).

Even regular fulfilling of all the maintenance operations described above may not completely prevent dirt accumulation in the air ducts which reduces the unit capacity. Duct maintenance means regular cleaning or replacement.

TROUBLESHOOTING

PROBLEM	POSSIBLE REASONS	TROUBLESHOOTING
The fan(s) do(es) not start.	No power supply.	Make sure the power supply line is connected correctly, otherwise troubleshoot a connection error.
Cold supply air.	Extract filter clogging.	Clean or replace the extract filter.
	Heat exchanger icing.	Check the heat exchanger for icing. Stop the unit operation if necessary and wait until the ice melts.
	Heater malfunction.	Contact the Seller.
Low air flow.	The filters, the fans or the heat exchanger is clogged.	Clean or replace the filters, clean the fans and the heat exchanger.
	The ventilation system is clogged or damaged.	Check for unobstructed opening of diffusers and louver shutters, check the exhaust hood and the supply grille and clean those, if necessary. Make sure the air ducts are clean and intact.
Noise, vibration.	The fan impellers are clogged.	Clean the impellers.
	The screw connection is loose.	Tighten the fastening screws.
Water leakage.	The drain pipe is clogged.	Contact the Seller.

STORAGE AND TRANSPORTATION REGULATIONS

- Store the unit in the manufacturer's original packaging box in a dry closed ventilated premise with temperature range from +5 °C to +40 °C and relative humidity up to 70 %.
- Storage environment must not contain aggressive vapors and chemical mixtures provoking corrosion, insulation, and sealing deformation.
- Use suitable hoist machinery for handling and storage operations to prevent possible damage to the unit.
- Follow the handling requirements applicable for the particular type of cargo.
- The unit can be carried in the original packaging by any mode of transport provided proper protection against precipitation and mechanical damage. The unit must be transported only in the working position.
- Avoid sharp blows, scratches, or rough handling during loading and unloading.
- Prior to the initial power-up after transportation at low temperatures, allow the unit to warm up at operating temperature for at least 3-4 hours.

MANUFACTURER'S WARRANTY

The product is in compliance with EU norms and standards on low voltage guidelines and electromagnetic compatibility. We hereby declare that the product complies with the provisions of Electromagnetic Compatibility (EMC) Directive 2014/30/EU of the European Parliament and of the Council, Low Voltage Directive (LVD) 2014/35/EU of the European Parliament and of the Council and CE-marking Council Directive 93/68/EEC. This certificate is issued following test carried out on samples of the product referred to above.

The manufacturer hereby warrants normal operation of the unit for 24 months after the retail sale date provided the user's observance of the transportation, storage, installation, and operation regulations. Should any malfunctions occur in the course of the unit operation through the Manufacturer's fault during the guaranteed period of operation, the user is entitled to get all the faults eliminated by the manufacturer by means of warranty repair at the factory free of charge. The warranty repair includes work specific to elimination of faults in the unit operation to ensure its intended use by the user within the guaranteed period of operation. The faults are eliminated by means of replacement or repair of the unit components or a specific part of such unit component.

The warranty repair does not include:

- routine technical maintenance
- unit installation/dismantling
- unit setup

To benefit from warranty repair, the user must provide the unit, the user's manual with the purchase date stamp, and the payment paperwork certifying the purchase. The unit model must comply with the one stated in the user's manual. Contact the Seller for warranty service.

The manufacturer's warranty does not apply to the following cases:

- User's failure to submit the unit with the entire delivery package as stated in the user's manual including submission with missing component parts previously dismantled by the user.
- Mismatch of the unit model and the brand name with the information stated on the unit packaging and in the user's manual.
- User's failure to ensure timely technical maintenance of the unit.
- External damage to the unit casing (excluding external modifications as required for installation) and internal components caused by the user.
- Redesign or engineering changes to the unit.
- Replacement and use of any assemblies, parts and components not approved by the manufacturer.
- Unit misuse.
- Violation of the unit installation regulations by the user.
- Violation of the unit control regulations by the user.
- Unit connection to power mains with a voltage different from the one stated in the user's manual.
- Unit breakdown due to voltage surges in power mains.
- Discretionary repair of the unit by the user.
- Unit repair by any persons without the manufacturer's authorization.
- Expiration of the unit warranty period.
- Violation of the unit transportation regulations by the user.
- Violation of the unit storage regulations by the user.
- Wrongful actions against the unit committed by third parties.
- Unit breakdown due to circumstances of insuperable force (fire, flood, earthquake, war, hostilities of any kind, blockades).
- Missing seals if provided by the user's manual.
- Failure to submit the user's manual with the unit purchase date stamp.
- Missing payment paperwork certifying the unit purchase.



FOLLOWING THE REGULATIONS STIPULATED HEREIN WILL ENSURE A LONG AND TROUBLE-FREE OPERATION OF THE UNIT.



USER'S WARRANTY CLAIMS SHALL BE SUBJECT TO REVIEW ONLY UPON PRESENTATION OF THE UNIT, THE PAYMENT DOCUMENT AND THE USER'S MANUAL WITH THE PURCHASE DATE STAMP.

CERTIFICATE OF ACCEPTANCE

Unit Type	Air handling unit
Model	MICRA 100
Serial Number	
Manufacture Date	
Quality Inspector's Stamp	

SELLER INFORMATION

Seller	
Address	
Phone Number	
E-mail	
Purchase Date	
This is to certify acceptance of the complete unit delivery with the user's manual. The warranty terms are acknowledged and accepted.	
Customer's Signature	

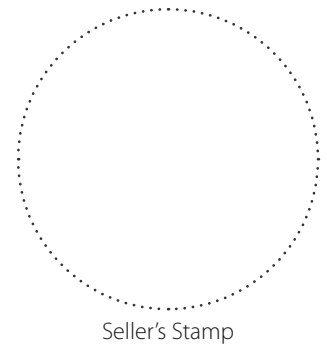

INSTALLATION CERTIFICATE

The MICRA 100 unit is installed pursuant to the requirements stated in the present user's manual.	
Company name	
Address	
Phone Number	
Installation Technician's Full Name	
Installation Date:	Signature:
The unit has been installed in accordance with the provisions of all the applicable local and national construction, electrical and technical codes and standards. The unit operates normally as intended by the manufacturer.	
Signature:	

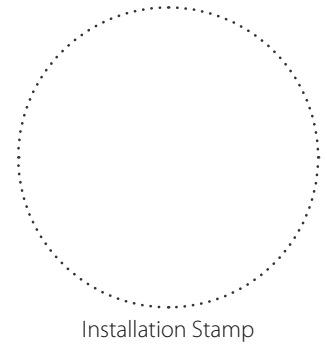

WARRANTY CARD

Unit Type	Air handling unit
Model	MICRA 100
Serial Number	
Manufacture Date	
Purchase Date	
Warranty Period	
Seller	

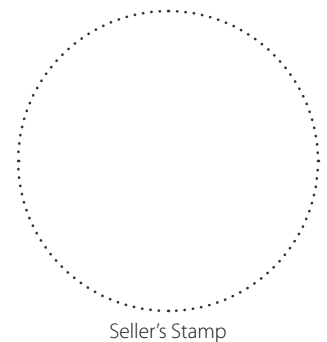



Air-Conditioning & Ventilation Components & Systems

Μιχαήλ Καραολή 19, τκ 143 43, Ν. Χαλκηδόνα, Αθήνα
Τηλ: 211 - 70.55.500 & 210 - 21.30.051, Fax: 210 - 22.23.283

