

# MICRA

Single-room air handling units with heat recovery





# PURPOSE



## PROBLEM 1: POOR AIR QUALITY

Inadequate ventilation of classrooms, offices and conference halls leads to poor air quality - specifically elevated humidity and CO<sub>2</sub> levels and reduced oxygen content. These effects can cause eye dryness and irritation, poor concentration and fatigue. It has been scientifically proven that poor air quality reduces work capacity in adults by 5-10 %.

Poor air quality has an even more pronounced effect on children which adversely affects their academic progress. The normal practice of classroom ventilation by opening windows only provides a short-term solution for the problem of poor air quality and it is at the cost of the warm air that is lost in the process. As a result, the CO<sub>2</sub> concentration in spaces that are intermittently ventilated by airing exceeds acceptable levels by several times.

Unlike this conventional approach, single-room ventilation ensures consistently high air quality in classrooms whilst maintaining the air temperature.



## PROBLEM 2: HEAT LOSSES

Among other priorities projects for retrofitting schools and other community buildings are always focused on reducing heating costs. Fitting modern windows and doors is an essential element of the solution. Air-tight seals between the components eliminate cold air leaks into the treated space as well as warm air losses through gaps.

This newly created, airtight environment, however, can create new issues with regards to air quality and the reduction of CO<sub>2</sub> and VOCs which would normally be removed passively by the property's air permeability.

Ventilation of air tight spaces can be effective when using mechanical ventilation with heat recovery.

## PROBLEM 3: LACK OF SPACE FOR VENTILATION FACILITIES IN RETROFITTING PROJECTS

Retrofitting existing structures presents a host of engineering challenges which often require unconventional creative solutions. Ensuring efficient ventilation in such projects is no exception. Some buildings completely lack free space for air ducts and ventilation equipment. In such cases centralised ventilation systems are of no use.

However, such engineering challenges can be met by fitting the treated spaces with single-room ventilation systems which do not require dedicated air ducts. High levels of humidity promote mould and germs which may trigger asthma and other allergies.

Proper ventilation is essential in order to eliminate this problem. Chemical compounds known as VOCs (volatile organic compounds) released by furniture, paint, carpets, cleaning products and a variety of other household items all contribute to indoor air pollution.

Carbon dioxide is a natural component of the Earth's atmosphere with outdoor air concentration ranging from 350 ppm in the country to 500 ppm in the city.

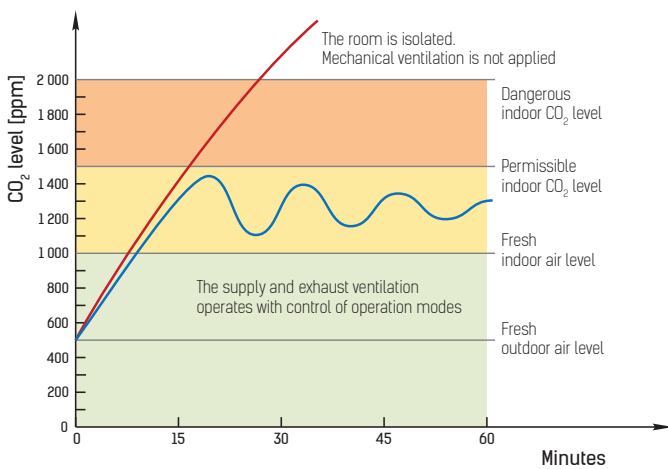

## SINGLE-ROOM VENTILATION ADVANTAGES

- Unit air flow capacity and type are selected based on the individual requirements of each particular space.
- Each space is ventilated on demand. The speed of MICRA units is set automatically to ensure the proper air quality.
- Fresh air is supplied through a short wall duct. No energy is wasted pushing air through long air ducts.
- Single-room ventilation improves fire safety due to the absence of air ducts between individual spaces.

## DISADVANTAGES OF CENTRAL VENTILATION SYSTEMS

- Central ventilation units can be large and require a dedicated space for installation.
- As a retrofit solution there can be some difficulties with installing air ducts between floors or through existing ceiling voids.



MICRA 100 WiFi APPLICATION  
IN AN OFFICE SPACE





# DESIGN GUIDELINES

DIN EN 15251 standard specifies indoor environmental input parameters for design and assessment of energy performance of buildings addressing indoor air quality, thermal environment, lighting and acoustics.

Category	Description
1	High standard. Recommended for rooms used by sensitive occupants with special needs (e.g. people with disabilities or patients undergoing medical treatment, infants, elderly people etc.).
2	Normal standard. Recommended for newly erected and renovated buildings.
3	Targeted / moderate standard. Can be applied to existing buildings.
4	Parameters beyond the above categories. This category can only be applied during a limited period.

The following table contains recommended ventilation system capacity per person as per DIN EN 13779. The aforementioned airflow is given in consideration of the contaminants released by furniture and construction materials.

Category	Measurement unit		Outdoor airflow							
			Non-smoking spaces				Smoking space			
			Common-type zone		Standard value		Common-type zone		Standard value	
1	l/s	m <sup>3</sup> /h	> 15	54 >	20	72	> 30	> 108	40	144
2	l/s	m <sup>3</sup> /h	10–15	36–54	12.5	45	20–30	72–108	25	90
3	l/s	m <sup>3</sup> /h	6–10	21.6–36	8	28.8	12–30	43.2–108	16	57.6
4	l/s	m <sup>3</sup> /h	< 6	< 21.6	5	18	< 12	< 43.2	10	36

Noise level requirements as per DIN EN 15251 and DIN EN 13779:

Building/room type	Sound pressure recommended range [dBA]
Open-space office	35–40
Conference hall	30–40
Classroom, kindergarten	35–45
Cafeteria/restaurant	35–50
Retail store	35–50



**MICRA 60** – is the single room air handling unit for balanced energy saving single room ventilation of flats, cottages, social and commercial premises. No need to connect air ducts. The best solution for simple and efficient ventilation in refurbished premises.

## FEATURES

- Efficient supply and exhaust ventilation for separate premises (rooms).
- Plate counter-flow plastic heat exchanger with recovery efficiency up to 79 %.
- EC fans with low energy demand and safe voltage of 12 V.
- Integrated automation with three operation modes.
- Silent operation (22-29 dBA).
- Air purification by two integrated G4 filters.
- Easy installation.
- Suitable for continuous operation.
- Switched-mode power supply unit for wide range of power supply voltage of 100-240 V and frequency of 50-60 Hz.



## OPERATING LOGIC

Fresh intake air from outside moves through the filter and the heat exchanger and is supplied to the premise with the supply axial fan. Warm stale air from the room moves through the filter and the heat exchanger and is exhausted outside with the exhaust axial fan. Heat energy of warm stale extract air is transferred to cold intake air in the heat exchanger. Heat recovery minimizes thermal energy losses and space heating expenses in cold seasons. The intake and extract air flows are fully separated and pollutants, odours and microbes contained in extract air are not transmitted to supply air.

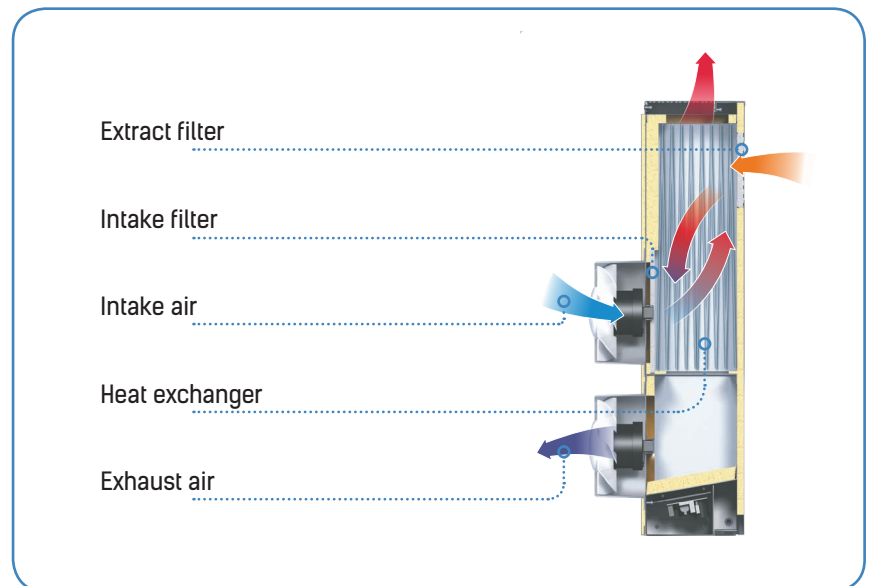

## CONTROL AND AUTOMATION

The unit is equipped with a sensor speed switch or a three-position speed switch.

Automation system enables three operation modes:

1. Supply and exhaust ventilation with minimum air flow rate of 30 m<sup>3</sup>/h and noise level of 22 dBA.
2. Supply and exhaust ventilation with medium air flow rate of 45 m<sup>3</sup>/h and noise level of 25 dBA.
3. Supply and exhaust ventilation with maximum air flow rate of 60 m<sup>3</sup>/h and noise level of 29 dBA.



A3: three-position speed switch (P3-1-300)

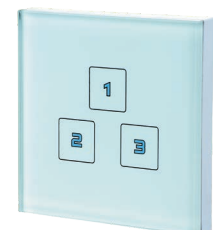

A4: sensor speed switch (SP3-1)

## CASING

Polymer coated metal casing decorated with mirror stainless steel. 15 mm PE foam thermal and sound insulating layer. Due to modern design, the unit matches well with any interior.

Removable front panel provides easy access for the unit servicing, i.e. for filter cleaning or replacement. Air is supplied to the room and exhausted outside through two Ø 125 mm air ducts.

## HEAT EXCHANGER

The unit is equipped with a high-tech plate counter-flow plastic heat exchanger. The heat exchanger recovers heat energy of extract air to warm up cold intake air. Heat recovery efficiency reaches 79 %. Combined application of MICRA single room air handling unit with air conditioners is not only the most efficient way to arrange desirable indoor microclimate but considerable cost saving because the heat exchanger saves heat in winter and cool in summer.

## FILTER

Two integrated G4 filters provide intake and extract air filtration. The filters ensure filtration of intake air from dust and insects and prevent the ventilator parts from soiling.

## POWER SUPPLY UNIT

The unit is powered through an integrated switched-mode power supply unit with a wide range of supply voltage from 100 to 240 V and frequency from 50 to 60 Hz. The power supply unit has integrated protection circuit for various emergencies including short circuit, overload, voltage jumps, reverse polarity in output circuits. The versatile characteristics of the power supply unit enable the product use in various countries and ensure its stable operation in power grid with wide tolerances of electricity standard.

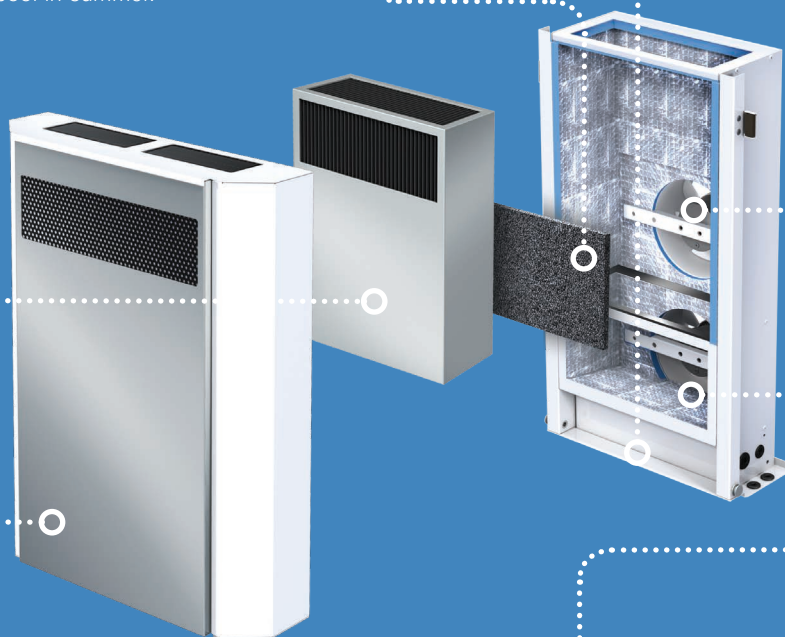

## FREEZE PROTECTION

The single room air handling unit is equipped with an integrated freeze protection system. In cold season the heat exchanger serves to transfer heat energy of warm extract air to cold intake air. During cooling of extract air condensate can form in the unit. It is drained outside through the exhaust air duct. If exhaust air temperature at outlet from the heat exchanger is below the set threshold value, the condensate may freeze inside the heat exchanger.

To prevent the heat exchanger freezing, electronic protection system is applied. It switches the supply fan off as the temperature sensor requires. Warm extract air defrosts the heat exchanger, then the supply fan switches on and the unit returns to normal operation.

## FANS

Axial EC fans provide air supply and air extraction. Due to EC technologies the single room air handling unit with heat recovery is featured with low energy demand. The fans are powered by electric safe low voltage of 12 V. The fan motors are equipped with integrated thermal overheating protection and ball bearings for longer service life.

# TECHNICAL DATA

Model	Speed	Unit voltage [V/50 (60) Hz]	Power [W]	Current [A]	Air flow [m³/h]	Heat recovery efficiency [%]	RPM [min <sup>-1</sup> ]	Sound pressure level at 3 m distance [dBA]	Ingress protection rating
MICRA 60	1	100-240	4.2	0.02	30	79	1165	22	IP22
	2		9.6	0.04	45	74	1720	25	
	3		15.4	0.07	60	70	2685	29	

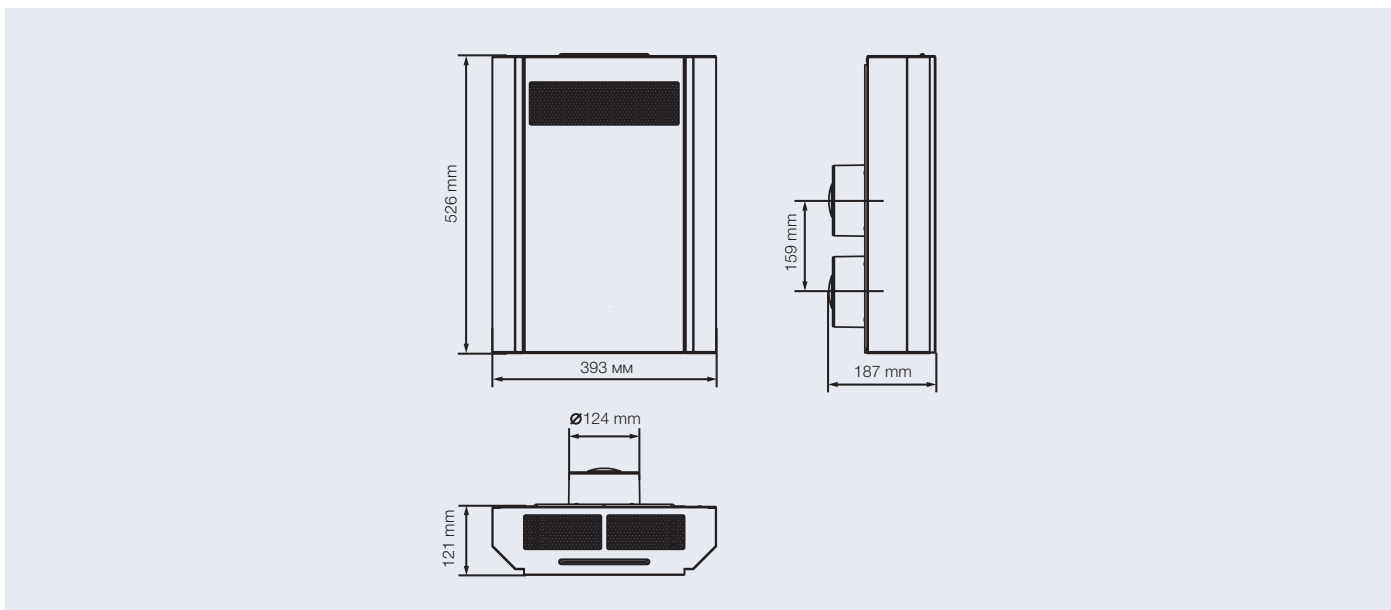

## ACCESSORIES

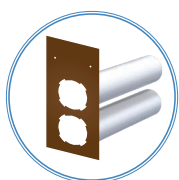

MK1 MICRA 60  
mounting kit

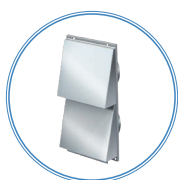

NB MICRA 60 outer  
ventilation box

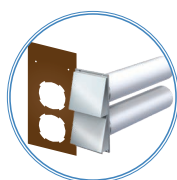

MK2 MICRA 60  
mounting kit

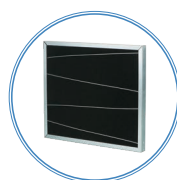

SF 216x147x10 G4  
G4 filter

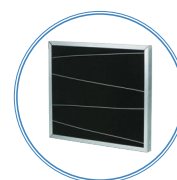

SF 279x88x10 G4  
G4 filter

# VENTILATION SYSTEM ARRANGEMENT

One MICRA 60 air handling unit should be installed in each space requiring ventilation. A single unit is capable of ensuring efficient ventilation in spaces with floor area up to 24 m<sup>2</sup>. Ventilation system based on the MICRA 60 single room air handling unit is able to provide nonstop air exchange, save heat in winter and cool in summer. To arrange the most energy efficient ventilation based on MICRA 60 units, we recommend to install intelligent VENTS iFan fans that extract stale air on a signal from the activated motion or humidity sensor in the kitchen or in the bathroom.

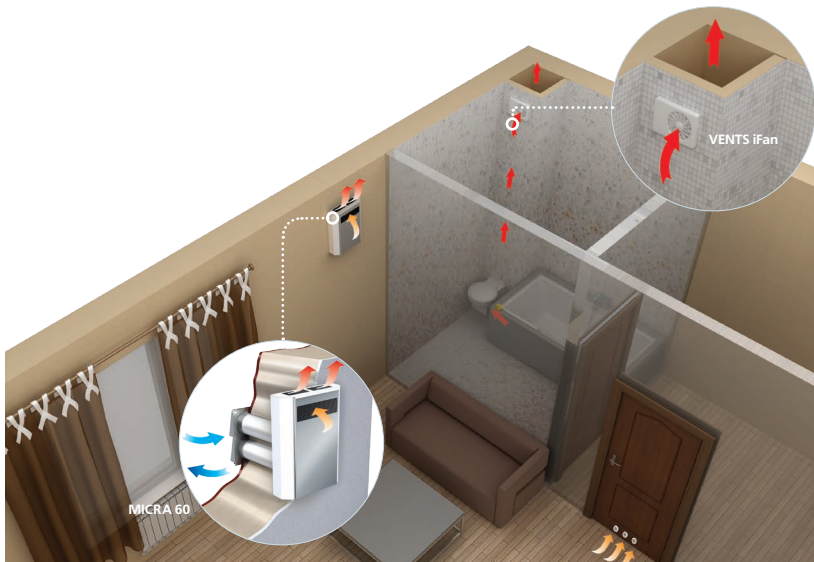

Mount the MICRA 60 single room air handling unit on the front wall from inside. The minimum wall thickness is 100 mm. First mark the holes on the wall for the air ducts with the paper master plate (included in the delivery set or in the MK1 and MK2 sets, page 8). After drilling the holes fix the master plate to the wall with a mounting tape. Insert the plastic air ducts (included in the MK1 and MK2 sets) into the holes. The master plate is used to place the air ducts in a required position and to align the unit spigots with the air ducts.

Install the outer hood (included in the MK2 set or purchased separately (NB)) on outer side of the wall to prevent ingress of water and foreign objects inside the unit. Install the air ducts slightly sloped down to outside to ensure condensate drainage from the unit.

After the air ducts are fixed in required position between the outer box and the master plate, fill the gaps between the air ducts and the wall with a mounting foam through special slots in the master plate. After the mounting foam hardens, remove the master plate and cut protruding parts of the air ducts to be flush with wall surface. Open the decorative plate and remove the heat exchanger prior to fastening the unit casing. While mounting the unit direct its spigots to the plastic air ducts and fix the unit to the wall with dowels and screws. The unit is supplied with a pre-wired power cable and a plug. The unit may be connected to the fixed wiring system through the terminal leads. This requires disconnecting the power cable from the terminal box and connecting the power cables led outside. After completing the casing mounting and electric connection re-install the heat exchanger and the front panel.

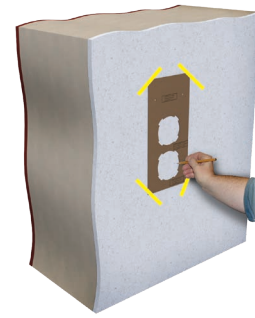

1

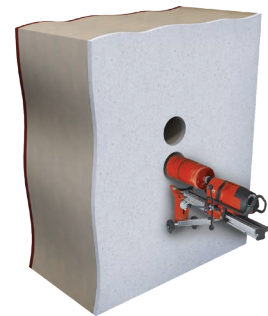

2

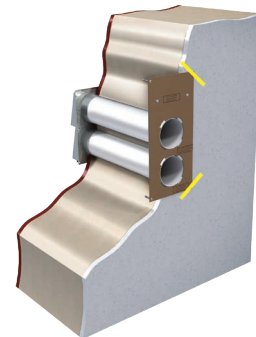

3

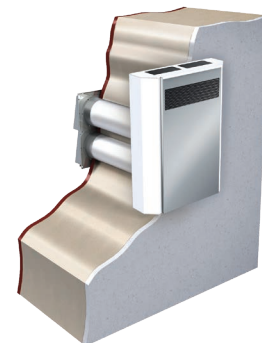

4





**MICRA 80 A3** is a single-room air handling unit for balanced energy saving ventilation of flats, cottages, social and commercial premises. No need to connect air ducts. This unit is ideally suited for creating simple yet highly efficient ventilation systems in newly erected and renovated spaces.

## FEATURES

- Efficient supply and exhaust ventilation of separate premises (rooms).
- Enthalpy cross-flow heat exchanger with heat recovery efficiency from 68 % up to 77 %.
- Centrifugal fans with forward curved blades.
- Asynchronous motors with ball bearings. Integrated control system with three operation modes and air flow range from 40 up to 80 m<sup>3</sup>/h.
- Silent operation (24/32/41 dBA).
- Air filtration with two integrated G4 filters.
- Easy installation.
- Suitable for continuous operation.



## OPERATING LOGIC

Fresh intake air from outside moves through the filter and the heat exchanger and is delivered to the premise with the supply fan. Warm stale air moves from the room through the filter and the heat exchanger and then is exhausted outside with the exhaust fan. Heat energy of warm extract air is transferred to clean intake air and warms it up. Heat recovery minimizes thermal energy losses and space heating expenses in cold seasons. Intake and extract air flows are fully separated within the heat exchangers and pollutants, odours and microbes contained in extract air are not transmitted to supply air.

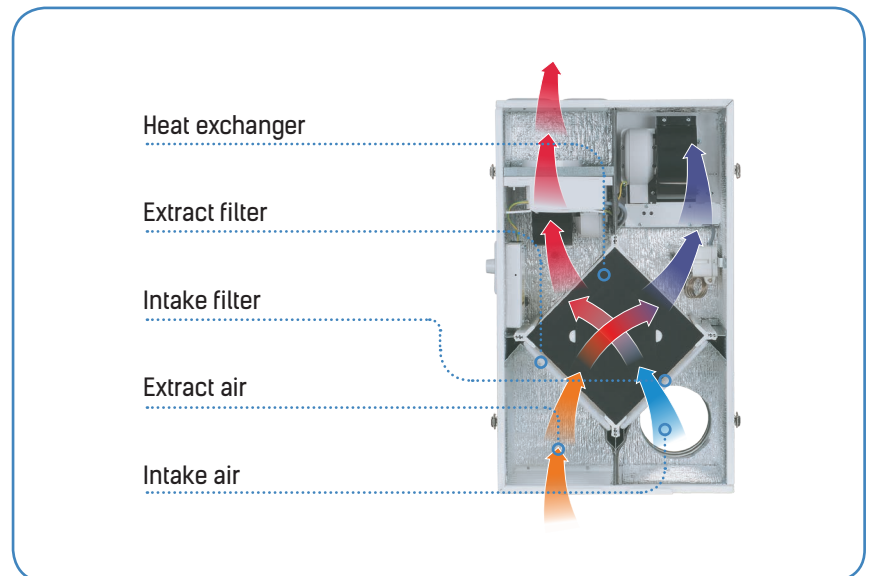

## CONTROL AND AUTOMATION

The unit is operated with a three-position speed switch.

The control system enables three operation modes:

1. Supply and exhaust ventilation with minimum air flow rate of 40 m<sup>3</sup>/h and noise level of 24 dBA.
2. Supply and exhaust ventilation with medium air flow rate of 60 m<sup>3</sup>/h and noise level of 32 dBA.
3. Supply and exhaust ventilation with maximum air flow rate of 80 m<sup>3</sup>/h and noise level of 41 dBA.



A3: three-position speed switch (P3-1-300)



## CASING

The casing is made of polymer coated metal and is heat- and sound-insulated with 15 mm polyethylene foam layer. Removable front panel provides easy access for unit servicing, i.e. for filter cleaning or replacement. Air is supplied to the room and exhausted outside through two Ø 125 mm air ducts.

## HEAT EXCHANGER

The unit is equipped with a high-tech enthalpy cross-flow heat exchanger. The heat exchanger recovers heat energy of extract air to warm up cold intake air. Heat recovery efficiency reaches 77 %. The applied heat exchanger enables not only heat but also humidity recovery. In warm seasons the heat exchanger operates to cool down and dehumidify the intake air. In cold seasons the heat exchanger operates to warm up intake air and to humidify it. Due to heat recovery process, the unit generates no condensate and requires no condensate drainage.

## FANS

The centrifugal fans with forward curved blades provide air supply and extraction. The fan motors with ball bearings are rated for a long service life.



## FREEZE PROTECTION

The unit is fitted with an integrated freeze protection system. The heat exchanger may be subjected to a freezing danger at low outside air temperatures. The exhaust air temperature falls down as ice accumulates in the heat exchanger. When exhaust air temperature falls down below a set point, the freeze protection thermostat is activated and shuts down the supply fan. The warm extract air flows through the heat exchanger until the extract air temperature rises above the set point. Then the supply fan turns on and the unit reverts to the standard operation mode.

## FILTER

Two integrated G4 filters are used to clean intake and extract air flows. The filters ensure delivery of fresh air free of dust and insects and protect the unit components from contamination.

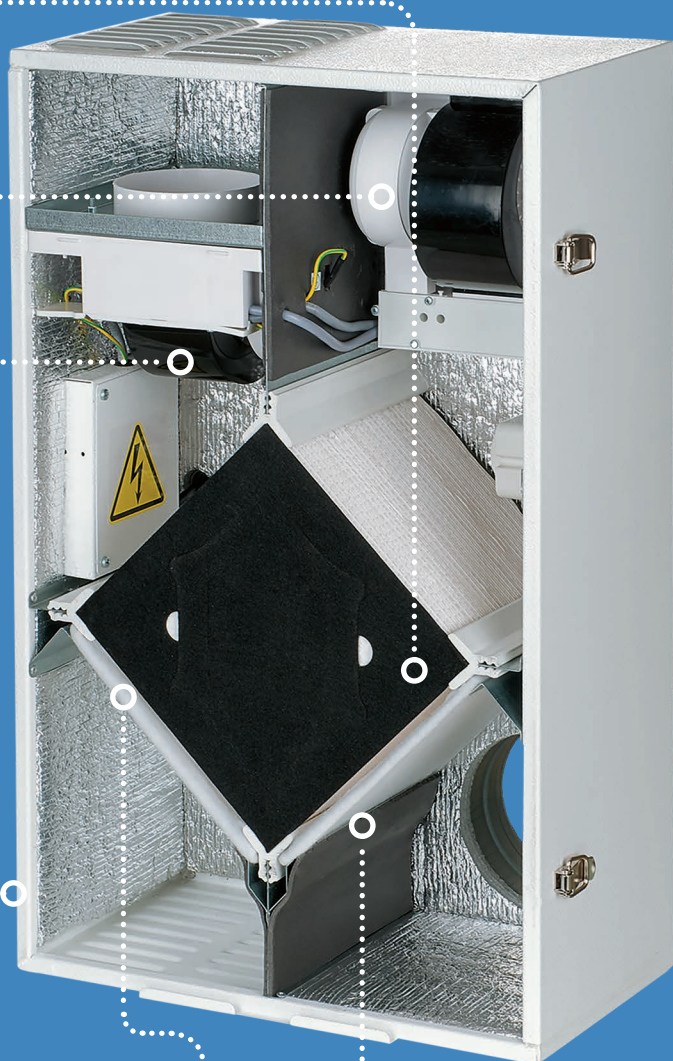

# TECHNICAL DATA

Model	MICRA 80 A3		
Speed	1	2	3
Voltage [V/50 Hz]	1~230		
Power [W]	25	35	57
Unit current [A]	0.15	0.20	0.34
Air flow [m³/h]	40	60	80
Noise level [dBA]	24	32	41
Maximum transported air temperature [°C]	-25...+40		
Casing material	Polymer-coated steel		
Insulation	15 mm, polyethylene foam		
Filter: extract/intake	G4		
Connected air duct diameter [mm]	125		
Weight [kg]	17		
Heat recovery efficiency [%]	68-77		
Heat exchanger type	Cross-flow		
Heat exchanger material	Enthalpy		

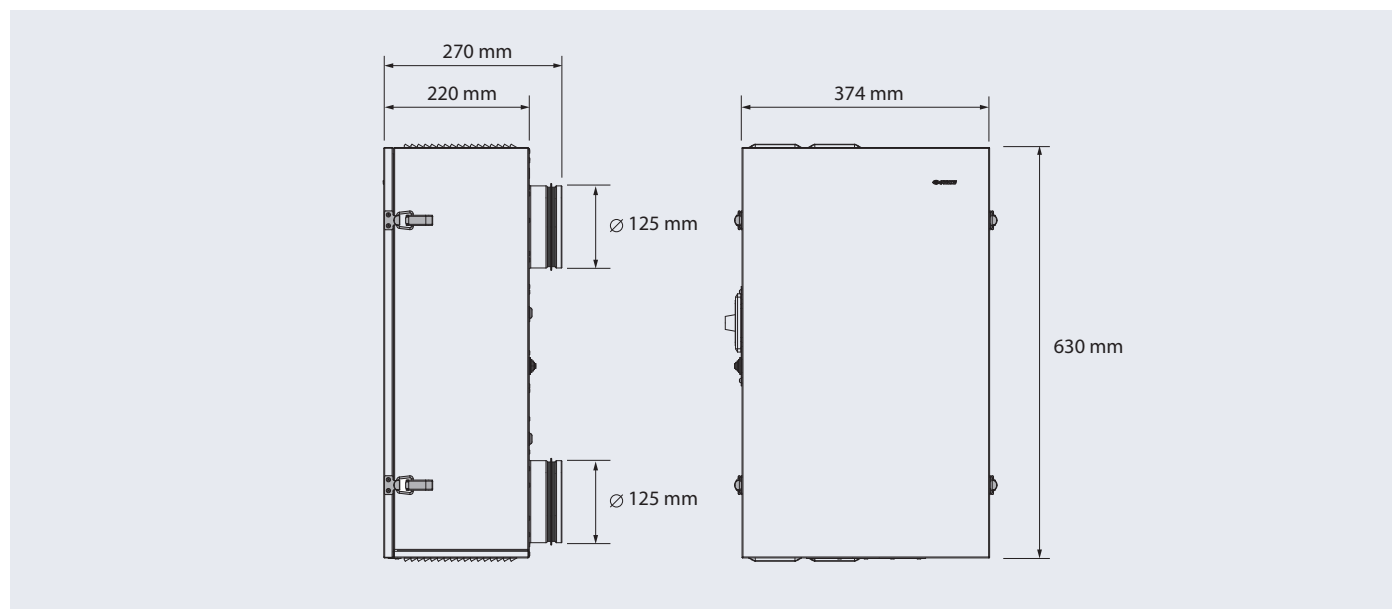

## ACCESSORIES



Round  $\varnothing$  125 mm telescopic air duct, adjustable length from 500 up to 1000 mm



MVM 122 bVs N stainless steel outer hood

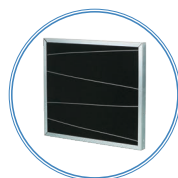

SF 195x195x6 G4 G4 filter

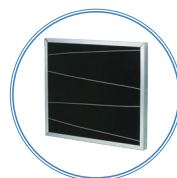

SF 195x195x6 G4 G4 filter

# VENTILATION SYSTEM ARRANGEMENT

One MICRA 80 A3 air handling unit should be installed in each space requiring ventilation. A single unit is capable of ensuring efficient ventilation in spaces with floor area up to 32 m<sup>2</sup>. A ventilation system based on MICRA 80 A3 is able to provide continuous air exchange and save heat in winter and cool in summer.

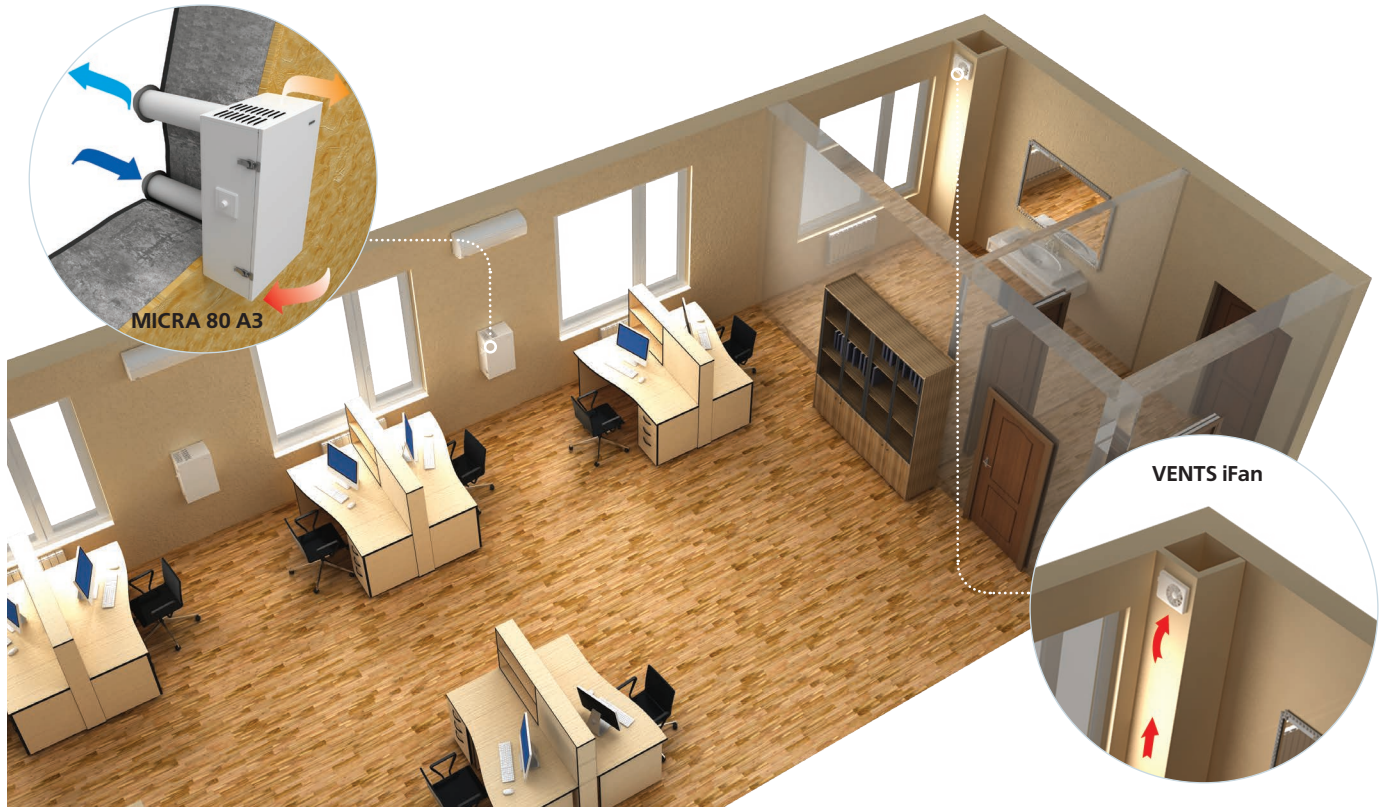

Mark the holes for the air ducts on the wall with the supplied cardboard master plate. After drilling the holes fix the master plate to the wall with a mounting tape. Insert the 125 mm plastic air ducts in the core holes.

The master plate is used to place the air ducts in a required position and to align the unit spigots with the air ducts.

Install the outdoor ventilation hoods from outside to prevent ingress of water and foreign objects inside the unit.

Install the air ducts slightly sloped down to outside to ensure condensate drainage from the unit.

After the air ducts are fixed in required position using the outer ventilation hoods and the master plate fill the gaps between the air ducts and the wall with a mounting foam through the special slots in the master plate.

After the mounting foam hardens, remove the master plate and cut protruding parts of the air ducts to be flush with wall surface.

To mount the unit casing, open the service panel and take off the heat exchanger.

Connect the unit spigots to the plastic air ducts and fix the unit casing to the wall with screws and dowels.

After completion of the casing mounting and wiring operations re-install the heat exchanger and the front panel.







**MICRA 100** is a single-room energy-efficient air handling unit intended for decentralised ventilation of residential and commercial spaces as well as apartments and houses. This unit is ideally suited for creating simple yet highly efficient ventilation systems in newly erected and renovated spaces without requiring duct installation.

## FEATURES

- Efficient solution for supply and exhaust ventilation of enclosed spaces.
- Models with an electric preheater or reheater are available for cold climate conditions.
- Modification with an enthalpy heat exchanger available for humid and hot climate conditions.
- EC fans with low energy consumption.
- Silent operation.
- Supply air purification ensured by two integrated G4 and F8 filters.
- Optionally – F8 Carbon, H13.
- Upgradeable with an extract air duct to provide air extraction from the bathroom.
- Easy installation.
- Compact size.
- Modern design.

## OPERATING LOGIC

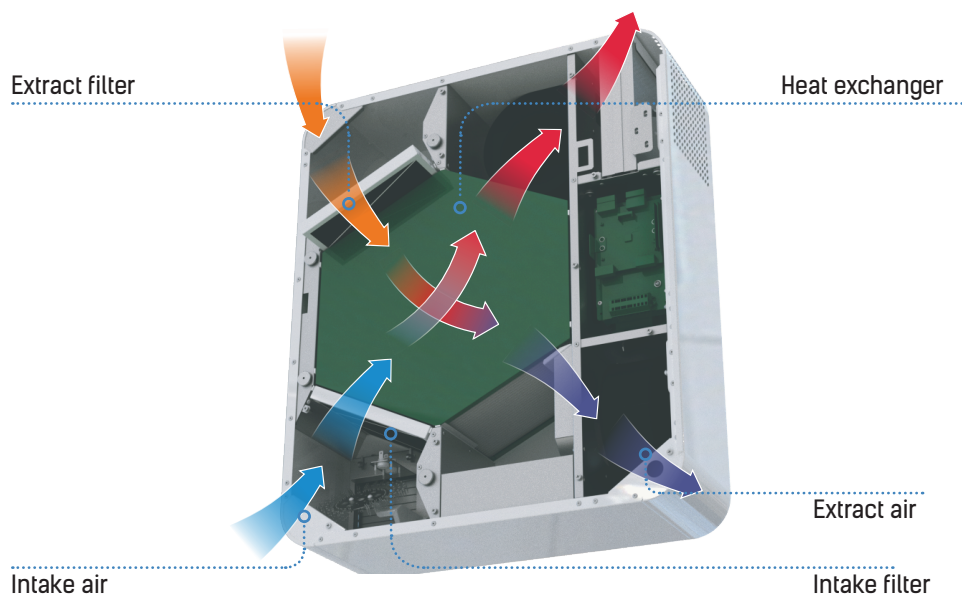

## CONTROL AND AUTOMATION

The unit is equipped with a control panel. A remote control is included in the delivery set.



- ① Switching the unit on/off
- ② Speed selection
- ③ Reheater temperature setpoint increase (for models equipped with a reheater)
- ④ Switching the reheater on/off (for models equipped with a reheater)
- ⑤ Reheater temperature setpoint decrease (for models equipped with a reheater)
- ⑥ Timer on/off
- ⑦ Scheduled operation on/off

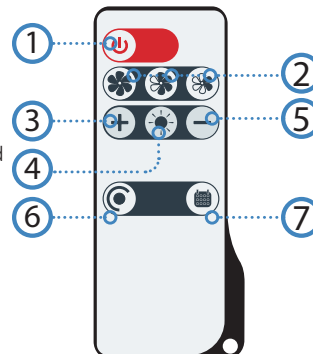

Available functions	MICRA 100 MICRA 100 E	MICRA 100 E1 MICRA 100 E2
Speed switching	+	+
Filter replacement indication	+	+
Alarm indication	+	+
Speed setting	+	+
Timer	+	+
Weekly schedule	+	+
Reheating on/off	-	+
Supply air temperature setting	-	+

## CASING

Polymer coated metal casing decorated with an acrylic front panel. Due to modern design, the unit matches well with any interior. Heat and sound insulation is ensured by a layer of 10 mm cellular synthetic rubber. The front panel provides convenient access for filter maintenance and has a lock for extra security. The unit has two  $\varnothing$  100 mm spigots for fresh air intake and stale air extraction outside. The third  $\varnothing$  100 mm spigot (included in the delivery set) can be additionally fitted to the unit to connect the extract air duct from the bathroom.

## FILTERS

Intake air cleaning is provided by G4 and F8 panel filters. To meet more stringent air purity requirements, an F8 filter can be replaced with an H13 filter (purchased separately). Extract air is cleaned by a panel G4 filter.

## ADDITIONAL SPIGOT

For air extraction from the bathroom.

## HEAT EXCHANGER

The MICRA 100 units are equipped with a counter-flow heat exchanger with a polystyrene core. In the cold season the extract air heat is transferred to the intake air stream which reduces heat losses through ventilation. However, this can lead to formation of condensate that is collected in a special drain pan and is drained off outside through the exhaust air duct. In the warm season the ambient air heat is transferred to the extract air. This allows for a considerable reduction of the supply air temperature which, in turn, reduces the air conditioning load.

The MICRA 100 ERV unit is equipped with a counter-flow enthalpy heat exchanger. In the cold season the extract air heat and moisture are transferred to the supply air stream through the enthalpy heat exchanger reducing the heat losses through ventilation. The ambient air heat and moisture are transferred to the extract air through the enthalpy heat exchanger in the warm season. This allows for a considerable reduction of the supply air temperature and humidity which, in turn, reduces the air conditioning load.

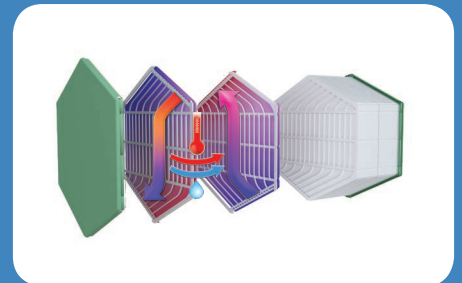
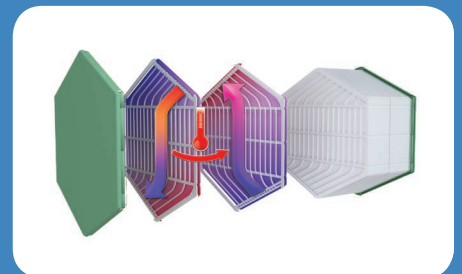

## SUPPLY AND EXHAUST AIR DAMPERS

The unit is equipped with supply and exhaust air dampers which activate automatically to prevent drafts while the unit is off.

## FREEZE PROTECTION

The MICRA 100 unit features an exhaust air temperature sensor downstream of the heat exchanger which disables the supply fan to let the warm extract air raise the heat exchanger temperature. Then the supply fan is turned on and the unit reverts to normal operation. Freeze protection for MICRA 100 and MICRA 100 E2 units is implemented with a preheater.





## FANS

The units feature efficient electronically commutated (EC) motors with an external rotor and impellers with forward curved blades. In addition to that, the efficiency of electronically commutated motors reaches very impressive levels of up to 90 %.



## CONTROL UNIT



## LIMIT SWITCH

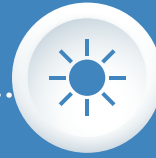

## REHEATING

The MICRA 100 E1 and MICRA 100 E2 units are equipped with an electric reheater to raise the supply air temperature when necessary.



## PREHEATING

The MICRA E and MICRA 100 E2 units are equipped with an electric preheater which protects the heat exchanger from freezing.



## DRAIN PAN



## NE MICRA 100 HEATER FOR CONDENSATE FREEZE PROTECTION (OPTIONAL)

Operation in a cold climate may result in condensate freezing in the exhaust air duct and the external hood. Therefore, it is recommended to install the NE MICRA 100 heater (purchased separately) to prevent icing.

# TECHNICAL DATA

	MICRA 100			MICRA 100 E			MICRA 100 E1			MICRA 100 E2		
Maximum air flow [m³/h]	30	60	100	30	60	100	30	60	100	30	60	100
Unit voltage [V/50 (60) Hz]	1 ~ 220-240			1 ~ 220-240			1 ~ 220-240			1 ~ 220-240		
Maximum fan power [W]	12	21	45	12	21	45	12	21	45	12	21	45
Sound pressure level at 3 m distance [dBA]	13	27	39	13	27	39	13	27	39	13	27	39
Electric preheater power [W]	-			700			-			700		
Electric reheater power [W]	-			-			350			350		
Maximum unit current (without an electric heater) [A]	0,4			0,4			0,4			0,4		
Maximum unit current (with an electric heater) [A]	-			3,08			1,94			4,67		
Transported air temperature [°C]	-15...+40											
Casing material	Painted steel											
Insulation	10 mm (foam rubber)											
Heat recovery efficiency [%]	98	92	89	98	92	89	98	92	89	98	92	89
Heat exchanger type	Counter-flow											
Heat exchanger material	Polystyrene											
Intake filter	G4, F8 Option: F8 Carbon, H13			G4, F8 Option: F8 Carbon, H13			G4			G4		
Extract filter	G4											
Connected air duct diameter [mm]	Ø 100											
Weight [kg]	31			31			31			31		
SEC class	A											

	MICRA 100 ERV			MICRA 100 E ERV			MICRA 100 E1 ERV			MICRA 100 E2 ERV		
Maximum air flow [m³/h]	30	60	100	30	60	100	30	60	100	30	60	100
Unit voltage [V/50 (60) Hz]	1 ~ 220-240			1 ~ 220-240			1 ~ 220-240			1 ~ 220-240		
Maximum fan power [W]	12	21	45	12	21	45	12	21	45	12	21	45
Sound pressure level at 3 m distance [dBA]	13	27	39	13	27	39	13	27	39	13	27	39
Electric preheater power [W]	-			700			-			700		
Electric reheater power [W]	-			-			350			350		
Maximum unit current (without an electric heater) [A]	0,4			0,4			0,4			0,4		
Maximum unit current (with an electric heater) [A]	-			3,08			1,94			4,67		
Transported air temperature [°C]	-15...+40											
Casing material	Painted steel											
Insulation	10 mm (foam rubber)											
Heat recovery efficiency [%]	96	89	83	96	89	83	96	89	83	96	89	83
Heat exchanger type	Counter-flow											
Heat exchanger material	Enthalpy											
Intake filter	G4, F8 Option: F8 Carbon, H13			G4, F8 Option: F8 Carbon, H13			G4			G4		
Extract filter	G4											
Connected air duct diameter [mm]	Ø 100											
Weight [kg]	31			31			31			31		
SEC class	A											



**ENERG** Y IJA  
енергия · ενεργεια  
 IE IA

**VENTS**
MICRA 100  
MICRA 100 ERV

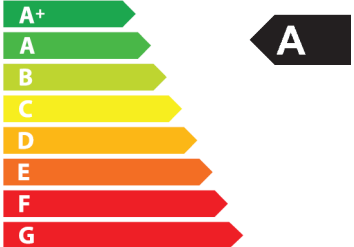

**47**  
dB

**100 m³/h**  

ENERGIJA · ЕНЕРГИЯ · ΕΝΕΡΓΕΙΑ · ENERGIJA · ENERGY · ENERGIE · ENERGI  
**2018** 1254/2014

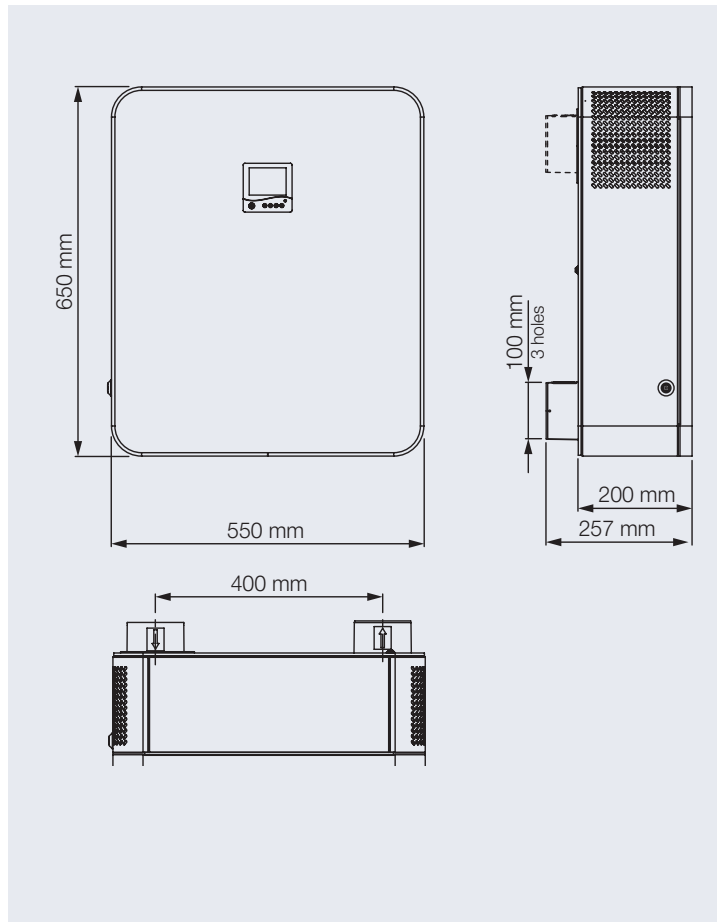
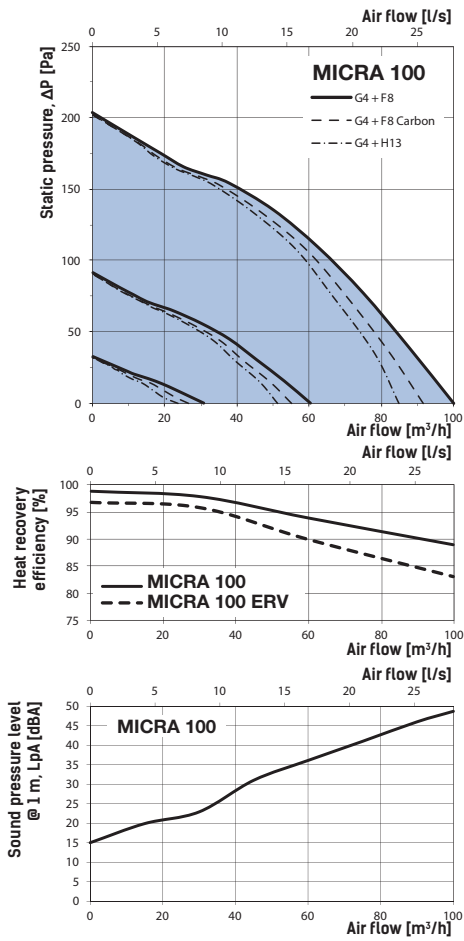

# ACCESSORIES



NB MICRA 100 white  
Outdoor box (white)

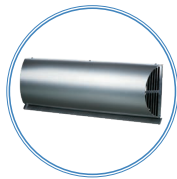

NB MICRA 100 chrome  
Brushed stainless steel  
outdoor box

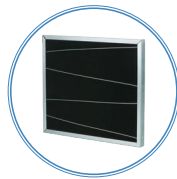

SF 193x158x18 G4  
G4 filter

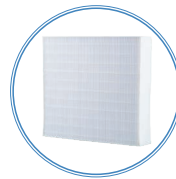

SF 193x158x47 F8  
F8 filter

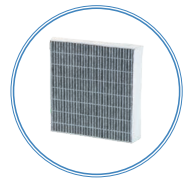

SF 193x158x47 F8 C  
F8 carbon filter

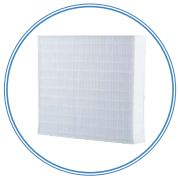

SF 193x158x47 H13  
H13 HEPA filter



HR-S  
HR-S humidity sensor



CO2-1  
CO<sub>2</sub> sensor with air quality  
indication and On/Off button



CO2-2  
CO<sub>2</sub> sensor

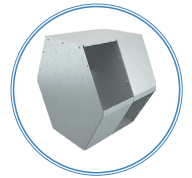

VL R6 366/157  
Summer block



- MICRA 100 white mounting kit:**
- two plastic  $\varnothing$  100 mm air ducts 500 mm long
  - outdoor box (white)
  - cardboard template

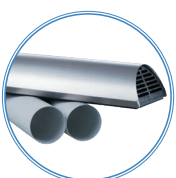

- MICRA 100 chrome mounting kit:**
- two plastic  $\varnothing$  100 mm air ducts 500 mm long
  - outdoor box (white)
  - cardboard template



- NE MICRA 100 Heater to prevent condensate freezing in the drain pipe and the outdoor box**

# VENTILATION SYSTEM ARRANGEMENT

Each space requiring proper ventilation should be equipped with a single or several MICRA 100 units. A single unit is capable of ensuring efficient ventilation in spaces with floor area up to 100 m<sup>2</sup>. MICRA 100 units can be upgraded with a bathroom extract air duct. For this, the units can be additionally equipped with an optional  $\varnothing$  100 mm spigot (included in the delivery set).

## MICRA 100 application in an office space

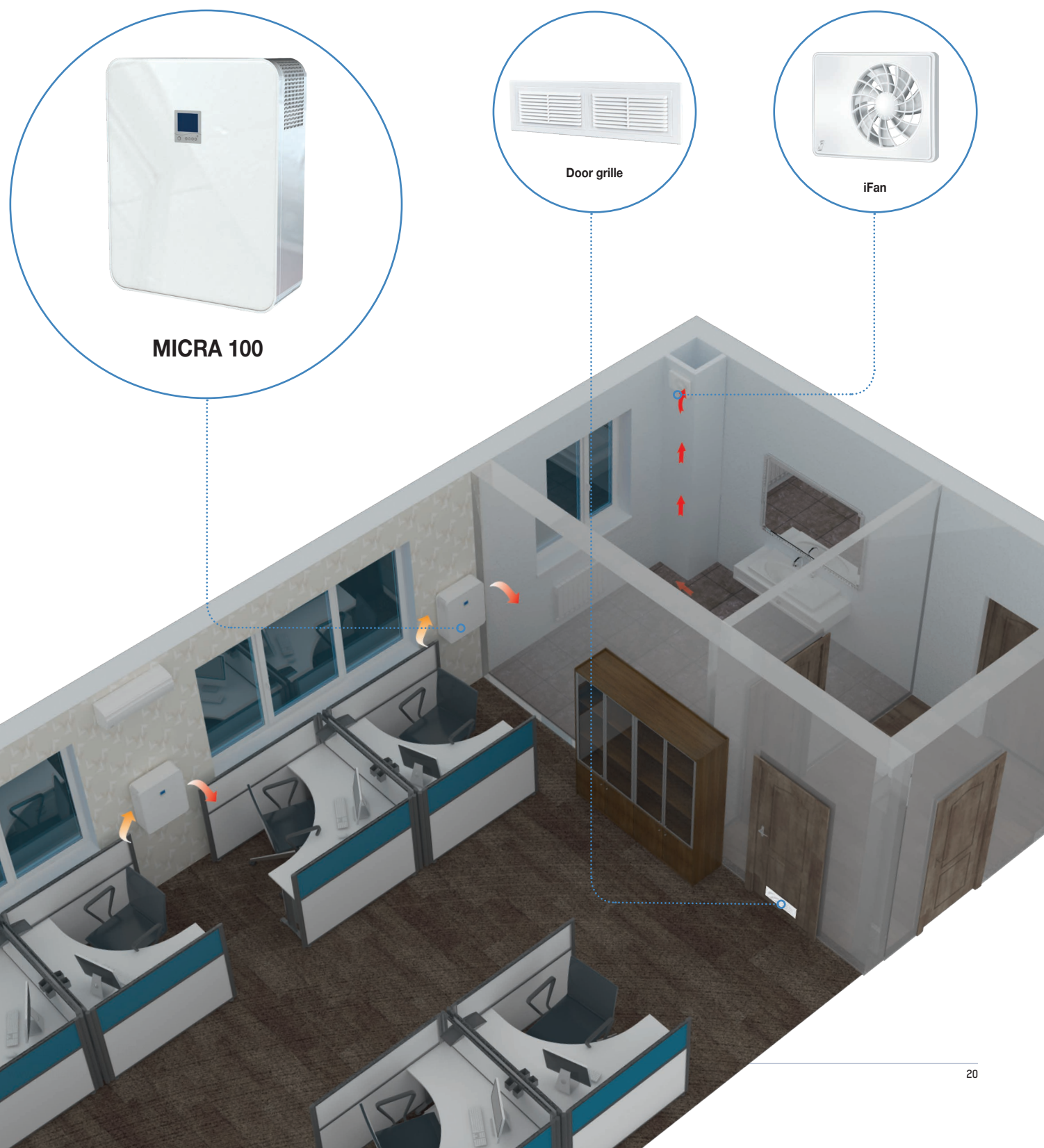



MICRA 100 application in a compact residential space

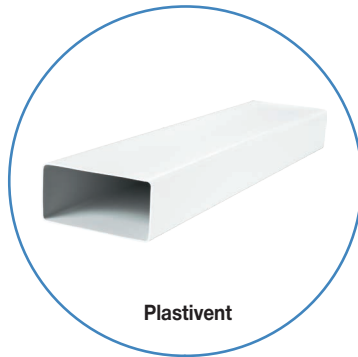



**MICRA 100 WiFi** is a single-room energy-efficient air handling unit intended for decentralised ventilation of residential and commercial spaces as well as apartments and houses. This unit is ideally suited for creating simple yet highly efficient ventilation systems in newly erected and renovated spaces without requiring duct installation.

## FEATURES

- Efficient solution for supply and exhaust ventilation of enclosed spaces.
- Models with an electric preheater or reheater are available for cold climate conditions.
- Modification with an enthalpy heat exchanger available for humid and hot climate conditions.
- EC motors with low energy demand.
- Silent operation.
- Supply air purification ensured by two integrated G4 and F8 filters. Optionally H13, F8 Carbon.
- Upgradeable with an extract air duct to provide air extraction from the bathroom.
- Easy installation.
- Compact size.
- Modern design.
- Control via Android/IOS mobile application.

## OPERATING LOGIC

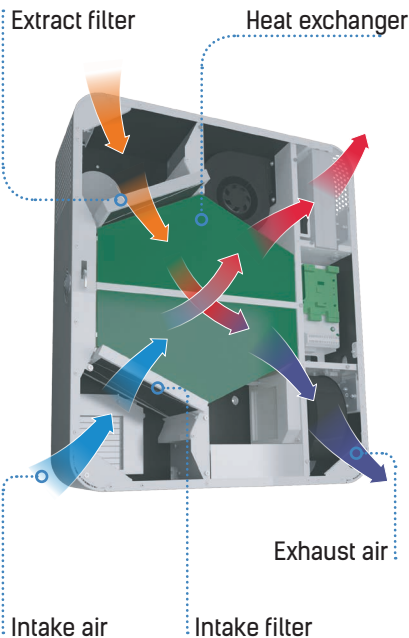

## CONTROL

- The units are equipped with a control panel
- A remote control is included in the delivery set
- Wi-Fi connection available
- Control via a smartphone or a tablet based on Android or IOS
- Control via Android/IOS mobile application

## FUNCTIONS

- Speed switching
- Filter replacement indication
- Alarm indication
- Speed setting
- Timer
- Weekly schedule





## CONTROL PANEL

Scheduled operation on/off

Turning the unit on/off

Speed setting



Wi-Fi connection

Alarm indication

Filter maintenance indication

- ① Switching the unit on/off
- ② Speed selection
- ③ Reheater temperature setpoint increase (for models equipped with a reheater)
- ④ Switching the reheater on/off (for models equipped with a reheater)
- ⑤ Reheater temperature setpoint decrease (for models equipped with a reheater)
- ⑥ Timer on/off
- ⑦ Scheduled operation on/off

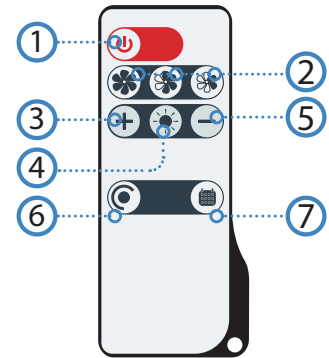

Available functions	MICRA 100 WiFi MICRA 100 E WiFi	MICRA 100 E1 WiFi MICRA 100 E2 WiFi
Speed switching	+	+
Filter replacement indication	+	+
Alarm indication	+	+
Speed setting	+	+
Timer	+	+
Weekly schedule	+	+
Reheating on/off	-	+
Supply air temperature setting	-	+
Control via VENTS MICRA Android/iOS mobile application	+	+

VENTS MICRA is available on the Google Play Store and the App Store



## CASING

Polymer coated metal casing decorated with an acrylic front panel. Due to modern design, the unit matches well with any interior. Heat and sound insulation is ensured by a layer of 10 mm cellular synthetic rubber. The front panel provides convenient access for filter maintenance and has a lock for extra security. The unit has two  $\varnothing$  100 mm spigots for fresh air intake and stale air extraction outside. The third  $\varnothing$  100 mm spigot (included in the delivery set) can be additionally fitted to the unit to connect the extract air duct from the bathroom.

## FILTERS

Intake air cleaning is provided by G4 and F8 panel filters. To meet more stringent air purity requirements, an F8 filter can be replaced with an H13 or F8 Carbon filter (purchased separately). Extract air is cleaned by a panel G4 filter.

## ADDITIONAL SPIGOT

For air extraction from the bathroom.

## HEAT EXCHANGER

The MICRA 100 WiFi units are equipped with a counter-flow heat exchanger with a polystyrene core. In the cold season the extract air heat is transferred to the intake air stream which reduces heat losses through ventilation. However, this can lead to formation of condensate that is collected in a special drain pan and is drained off outside through the exhaust air duct. In the warm season the ambient air heat is transferred to the extract air. This allows for a considerable reduction of the supply air temperature which, in turn, reduces the air conditioning load.

The MICRA 100 WiFi ERV unit is equipped with an enthalpy counter-flow heat exchanger. In the cold season the extract air heat and moisture are transferred to the supply air stream through the enthalpy heat exchanger reducing the heat losses through ventilation. The ambient air heat and moisture are transferred to the extract air through the enthalpy heat exchanger in the warm season. This allows for a considerable reduction of the supply air temperature and humidity which, in turn, reduces the air conditioning load.

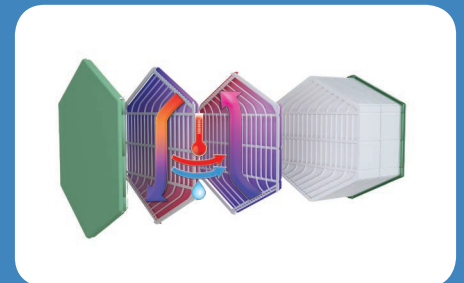
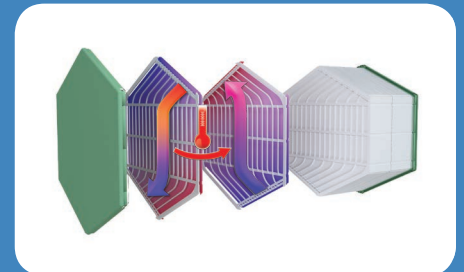

## SUPPLY AND EXHAUST AIR DAMPERS

The unit is equipped with supply and exhaust air dampers which activate automatically to prevent drafts while the unit is off.

## FREEZE PROTECTION

The MICRA 100 WiFi unit features an exhaust air temperature sensor downstream of the heat exchanger which disables the supply fan to let the warm extract air raise the heat exchanger temperature. Then the supply fan is turned on and the unit reverts to normal operation. Freeze protection for the MICRA 100 E WiFi and MICRA 100 E2 WiFi units is implemented with a preheater.



## FANS

The units feature efficient electronically commutated (EC) motors with an external rotor and impellers with forward curved blades. In addition to that, the efficiency of electronically commutated motors reaches very impressive levels of up to 90 %.



## CONTROL UNIT

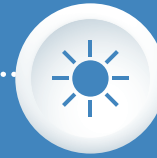

## REHEATING

The MICRA 100 E1 WiFi and MICRA 100 E2 WiFi units feature an electric reheater to raise the supply air temperature when necessary.



## PREHEATING

The MICRA 100 E WiFi and MICRA 100 E2 WiFi units are equipped with an electric preheater which protects the heat exchanger from freezing.



## DRAIN PAN



## NE MICRA 100 HEATER FOR CONDENSATE FREEZE PROTECTION (OPTIONAL)

Operation in a cold climate may result in condensate freezing in the exhaust air duct and the external hood. Therefore, it is recommended to install the NE MICRA 100 heater (purchased separately) to prevent icing.

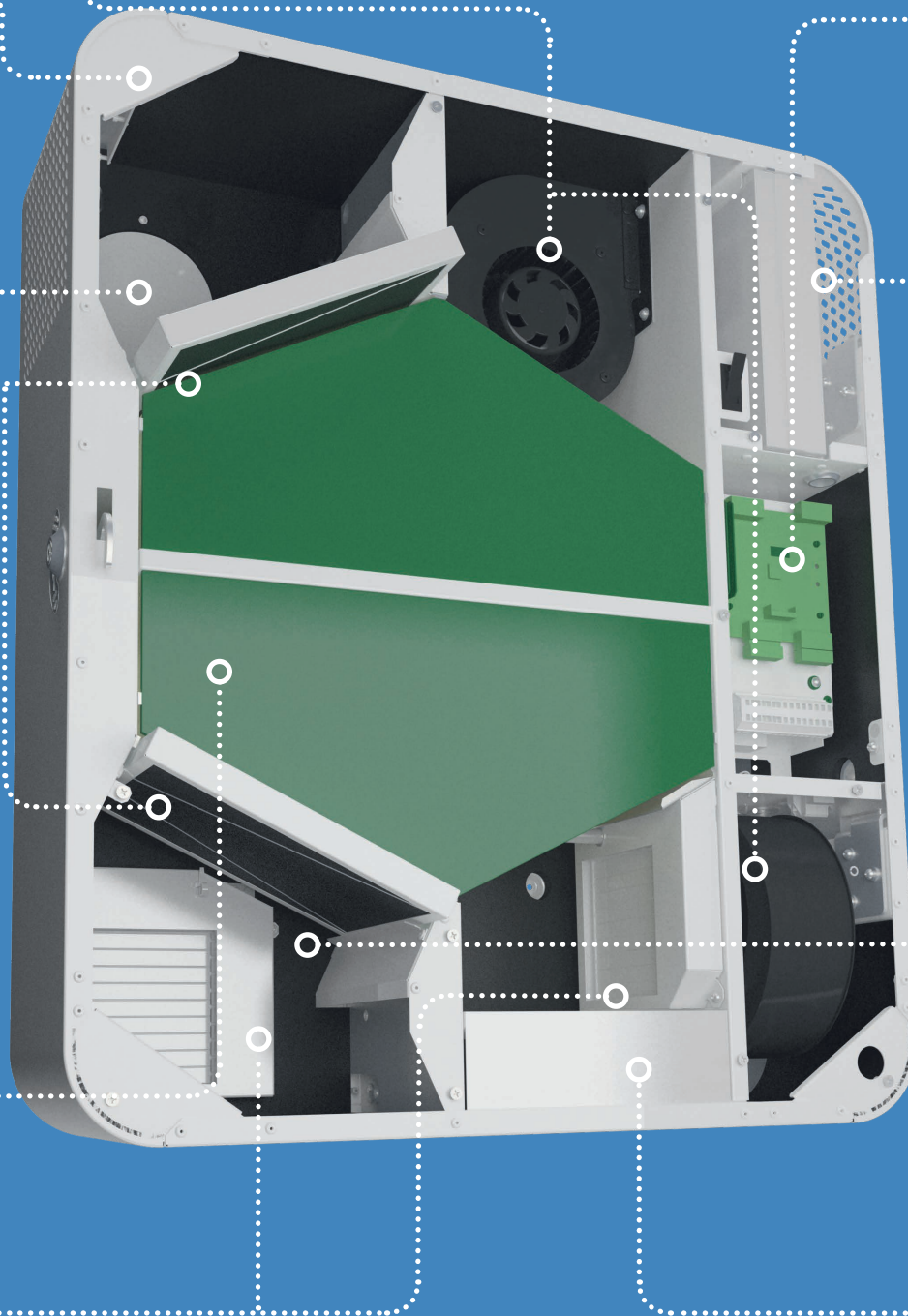

# TECHNICAL DATA

Parameters	MICRA 100 WiFi					MICRA 100 ERV WiFi					MICRA 100 E WiFi					MICRA 100 E ERV WiFi				
	1	2	3	4	5	1	2	3	4	5	1	2	3	4	5	1	2	3	4	5
Speed																				
Supply voltage [V/50 (60) Hz]	1~220-240										1~220-240									
Maximum unit power without an electric heater [W]	20	23	29	37	53	20	23	29	37	53	20	23	29	37	53	20	23	29	37	53
Preheating power [W]											700					700				
Reheating power [W]																				
Maximum unit current (without an electric heater) [A]	0,4					0,4					0,4					0,4				
Maximum unit current (with an electric heater) [A]											3,6					3,6				
Maximum air flow [m³/h]	30	44	60	75	100	30	44	60	75	100	30	44	60	75	100	30	44	60	75	100
RPM [min <sup>-1</sup> ]	2200																			
Sound pressure level at 3 m distance [dBA]	13	20	27	33	39	13	20	27	33	39	13	20	27	33	39	13	20	27	33	39
Transported air temperature [°C]	-15...+40																			
Casing material	Polymer-coated steel																			
Insulation [mm]	10																			
Extract filter	G4																			
Intake filter	G4, F8 Option: F8 Carbon, H13																			
Connected air duct diameter [mm]	100																			
Weight [kg]	31																			
Heat recovery efficiency [%]*	98	95	92	90	89	96	94	89	85	83	98	95	92	90	89	96	94	89	85	83
Heat exchanger type	Counter-flow																			
Heat exchanger material	Polystyrene					Enthalpy					Polystyrene					Enthalpy				
SEC class	A					A					A					A				

Parameters	MICRA 100 E1 WiFi					MICRA 100 E1 ERV WiFi					MICRA 100 E2 WiFi					MICRA 100 E2 ERV WiFi				
	1	2	3	4	5	1	2	3	4	5	1	2	3	4	5	1	2	3	4	5
Speed																				
Supply voltage [V/50 (60) Hz]	1~220-240					1~220-240					1~220-240					1~220-240				
Maximum unit power without an electric heater [W]	20	23	29	37	53	20	23	29	37	53	20	23	29	37	53	20	23	29	37	53
Preheating power [W]											700					700				
Reheating power [W]	350					350					350					350				
Maximum unit current (without an electric heater) [A]	0,4					0,4					0,4					0,4				
Maximum unit current (with an electric heater) [A]	1,94					1,94					5,2					5,2				
Maximum air flow [m³/h]	30	44	60	75	100	30	44	60	75	100	30	44	60	75	100	30	44	60	75	100
RPM [min <sup>-1</sup> ]	2200					2200					2200					2200				
Sound pressure level at 3 m distance [dBA]	13	20	27	33	39	13	20	27	33	39	13	20	27	33	39	13	20	27	33	39
Transported air temperature [°C]	-15...+40																			
Casing material	Polymer-coated steel																			
Insulation [mm]	10					10					10					10				
Extract filter	G4																			
Intake filter	G4																			
Connected air duct diameter [mm]	100					100					100					100				
Weight [kg]	31					31					31					31				
Heat recovery efficiency [%]*	98	95	92	90	89	96	94	89	85	83	98	95	92	90	89	96	94	89	85	83
Heat exchanger type	Counter-flow																			
Heat exchanger material	Polystyrene					Enthalpy					Polystyrene					Enthalpy				
SEC class	A					A					A					A				

\*Heat recovery efficiency according to EN 13141-8.

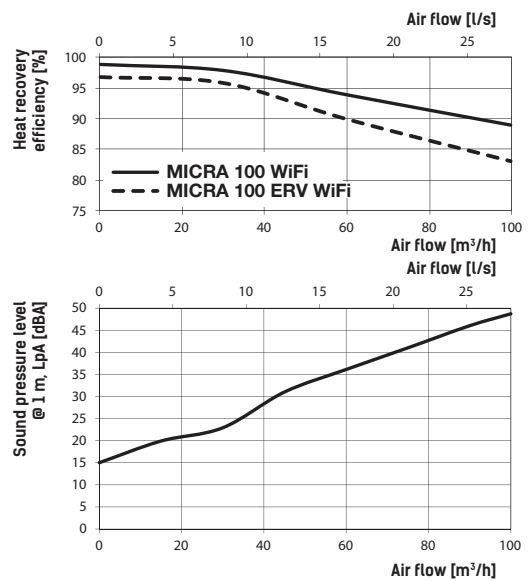
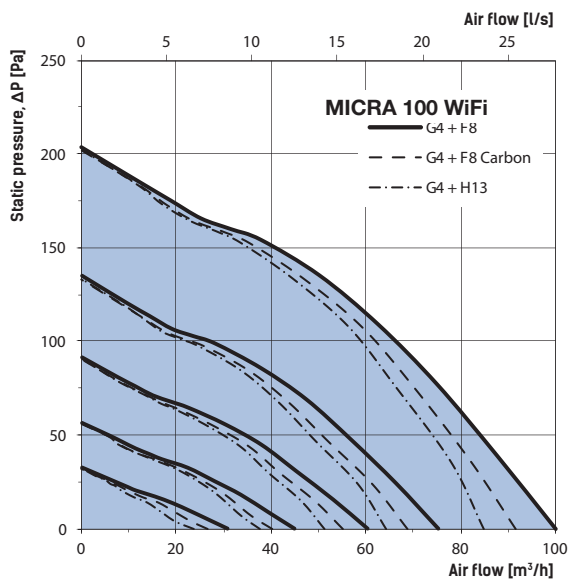

	MICRA 100 WiFi					
	Cold		Average		Warm	
Specific energy consumption (SEC) [kWh/(m <sup>2</sup> .a)]	-79.4	A+	-39.7	A	-14.3	E
Type of ventilation unit	Bidirectional					
Type of drive installed	With variable rotation frequency					
Type of heat recovery system	Regenerative					
Thermal efficiency of heat recovery [%]	92					
Maximum flow rate [m <sup>3</sup> /h]	100					
Power [W]	53					
Sound power level [dBA]	47					
Reference flow rate [m <sup>3</sup> /s]	0.017					
Reference pressure difference [Pa]	N/A					
Specific power input (SPI) [W/m <sup>3</sup> /h]	0.483					
Control typology	Local demand control					
Maximum internal leakage rates [%]	0.1					
Maximum external leakage rates [%]	0.9					
Mixing rate of bidirectional units [%]	20					
Airflow sensitivity at +20 Pa and -20 Pa	0.93					
The indoor/outdoor air tightness [m <sup>3</sup> /h]	7					
Internet address	<a href="http://www.ventilation-system.com">http://www.ventilation-system.com</a>					
The annual electricity consumption (AEC) [kWh electricity/a]	Cold		Average		Warm	
	863		326		281	
The annual heating saved (AHS) [kWh primary energy/a]	Cold		Average		Warm	
	9230		4718		2133	

**ENERG** Y IJA  
енергия · енергия  
IE IA

**VENTS**      **MICRA 100 WiFi**

**47**  
**dBA**

**100**  
**m<sup>3</sup>/h**

ENERGIA · ЕНЕРГИЯ · ΕΝΕΡΓΕΙΑ · ENERGIJA · ENERGY · ENERGIE · ENERGI  
2018      1254/2014



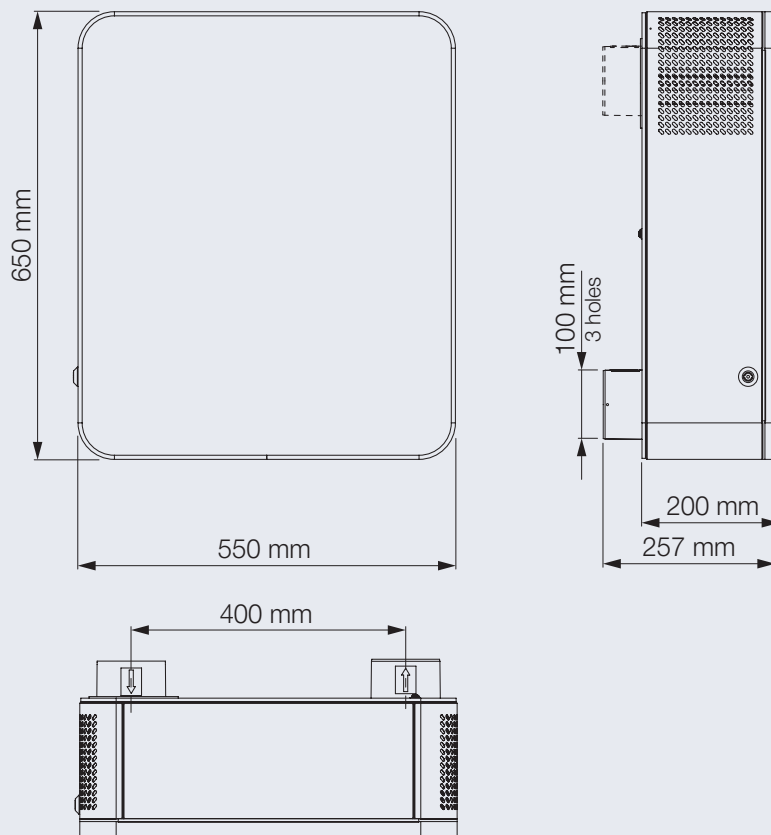

# ACCESSORIES



NB MICRA 100 white  
Outdoor box (white)

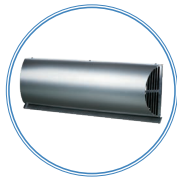

NB MICRA 100 chrome  
Brushed stainless steel  
outdoor box

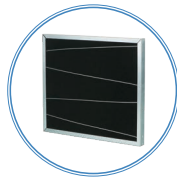

SF 193x158x18 G4  
G4 filter

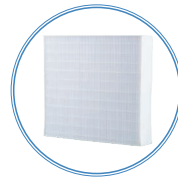

SF 193x158x47 F8  
F8 filter

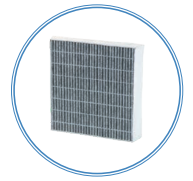

SF 193x158x47 F8 C  
F8 carbon filter

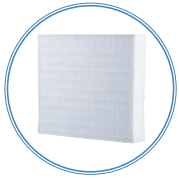

SF 193x158x47 H13  
H13 HEPA-filter



HR-S  
HR-S humidity sensor



CO<sub>2</sub>-1  
CO<sub>2</sub> sensor with air quality  
indication and On/Off button



CO<sub>2</sub>-2  
CO<sub>2</sub> sensor

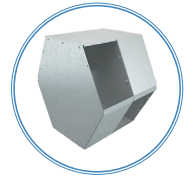

VL R6 366/157  
Summer block



MICRA 100 white mounting kit:

- two plastic Ø 100 mm air ducts 500 mm long
- outdoor box (white)
- cardboard template

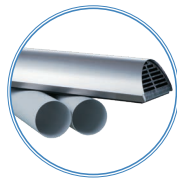

MICRA 100 chrome mounting kit:

- two plastic Ø 100 mm air ducts 500 mm long
- outdoor box (white)
- cardboard template



NE MICRA 100  
Heater to prevent condensate  
freezing in the drain pipe and the  
outdoor box

# VENTILATION SYSTEM ARRANGEMENT

Each space requiring proper ventilation should be equipped with a single or several MICRA 100 WiFi units. A single unit is capable of ensuring efficient ventilation in spaces with floor area up to 100 m<sup>2</sup>. The MICRA 100 WiFi unit can be upgraded with a bathroom extract air duct. For this, the units can be additionally equipped with an optional  $\varnothing$  100 mm spigot (included in the delivery set).

## MICRA 100 WiFi application in an office space

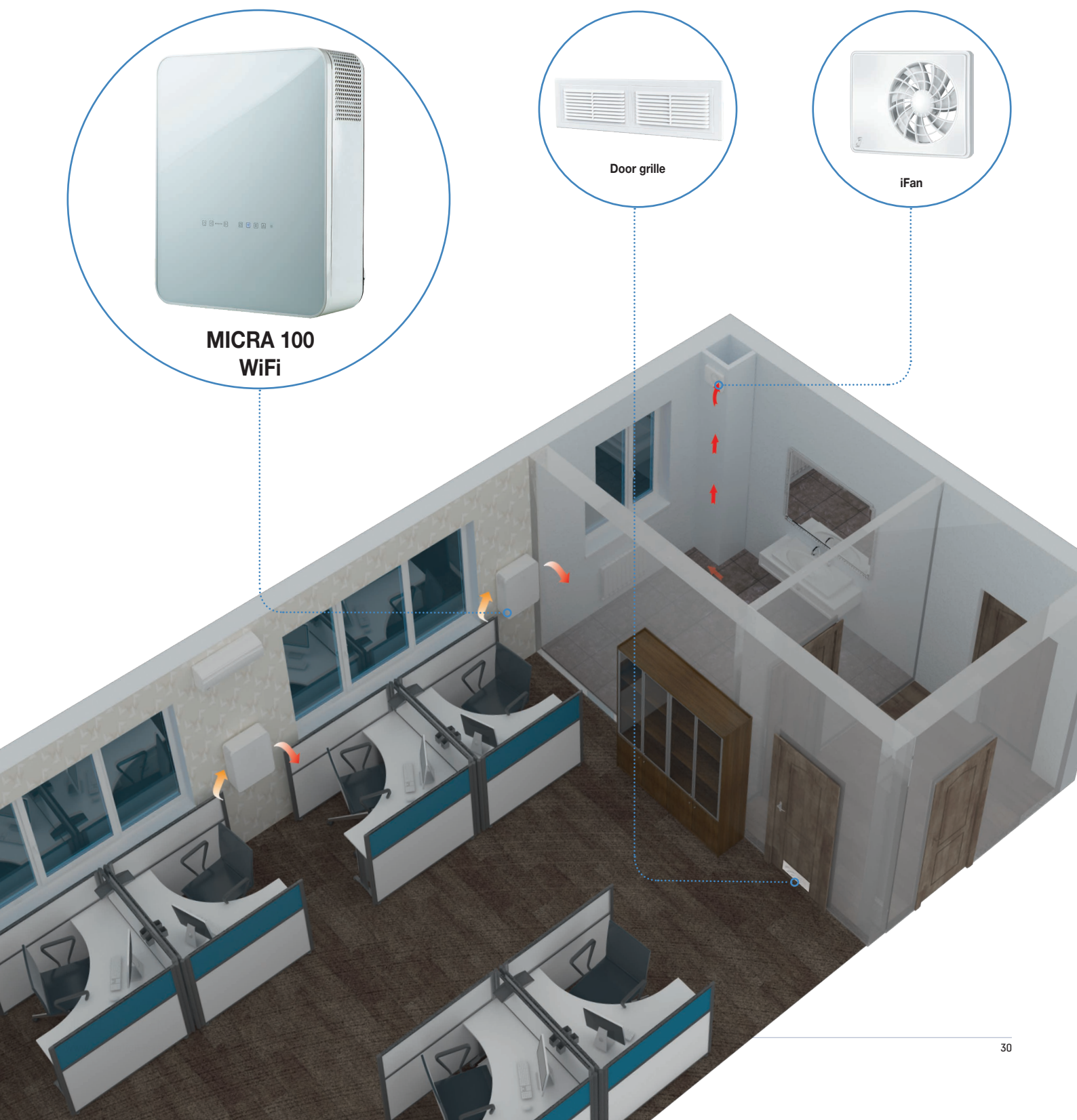

MICRA 100 WiFi application in a compact residential space

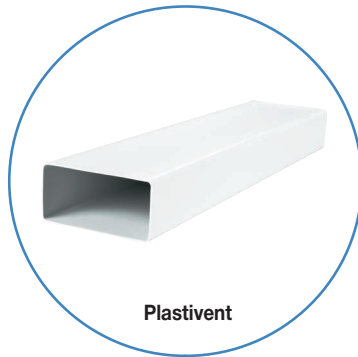



**MICRA 200 ERV WiFi** is a single-room energy-efficient air handling unit intended for decentralised ventilation of residential and commercial spaces as well as apartments and houses. This unit is ideally suited for creating simple yet highly efficient ventilation systems in newly erected and renovated spaces without requiring duct installation.

## FEATURES

- Efficient solution for supply and exhaust ventilation of enclosed spaces.
- Available modifications with an electric preheater and/or reheater for cold climate conditions.
- EC motors with low energy demand.
- Supply air purification up to 99 % ensured by two integrated G4 and F7 filters. Additional air purification due to recirculation. An H13 filter is optionally available.
- Upgradeable with an extract air duct to provide air extraction from the bathroom.
- Easy installation.
- Compact size.
- Modern design.
- Control via Android/IOS mobile application.



The supply and exhaust air dampers close when the air purification function is turned on. The recirculation damper opens. The room air circulates through the filters. Then it is returned purified back to the room.

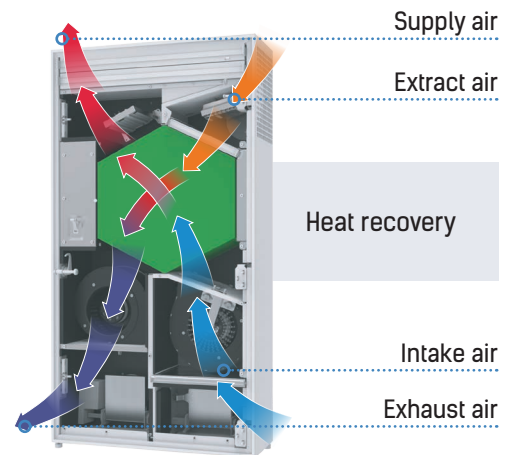
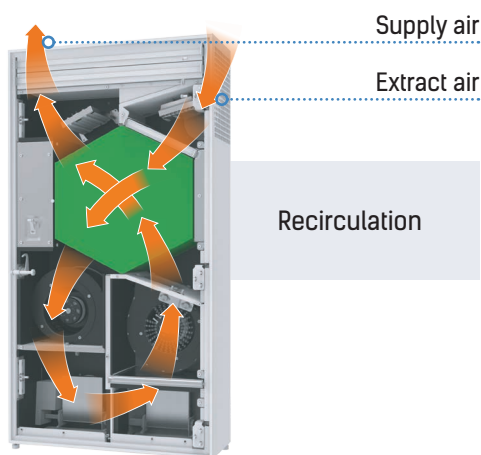



## CONTROL

- The units are equipped with a control panel.
- A remote control is included in the delivery set.
- WiFi connection available.
- Control via a smartphone or a tablet based on Android or IOS.
- Control via Android/IOS mobile application.



VENTS MICRA is available on the Google Play Store and the App Store

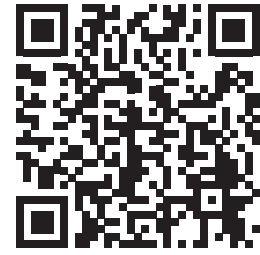
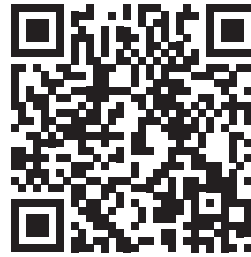

## CONTROL PANEL

Scheduled operation on/off

Turning the unit on/off

Speed setting

Wi-Fi connection

Alarm indication

Filter maintenance indication

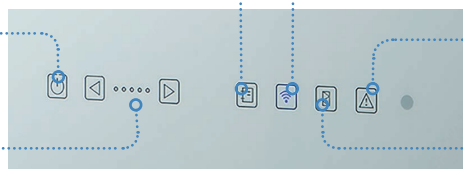

- 1 Switching the unit on/off
- 2 Speed selection
- 3 Reheater temperature setpoint increase (for models equipped with a reheater)
- 4 Switching the reheater on/off (for models equipped with a reheater)
- 5 Reheater temperature setpoint decrease (for models equipped with a reheater)
- 6 Timer on/off
- 7 Scheduled operation on/off

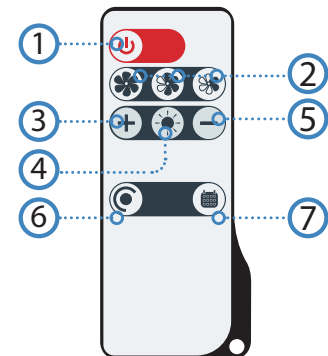

Available functions	MICRA 200 ERV WiFi MICRA 200 E ERV WiFi	MICRA 200 E1 ERV WiFi MICRA 200 E2 ERV WiFi
Speed switching	+	+
Filter replacement indication	+	+
Alarm indication	+	+
Speed setting	+	+
Timer	+	+
Weekly schedule	+	+
Reheating on/off	-	+
Supply air temperature setting	-	+
Control via VENTS MICRA Android/iOS mobile application	+	+



## SUPPLY AIR REHEATER

The MICRA 200 E1 ERV WiFi and MICRA 200 E2 ERV WiFi units are equipped with an electric reheater to raise the supply air temperature when necessary.



## FANS

The units are equipped with efficient electronically commutated (EC) motors with an external rotor and impellers with forward curved blades. These state-of-the-art motors are the most advanced solution in energy efficiency today. EC motors are characterised with high performance and optimum control across the entire speed range. In addition to that, the efficiency of electronically commutated motors reaches very impressive levels of up to 90 %.



## SUPPLY AND EXHAUST AIR DAMPERS

The unit is equipped with supply and exhaust air dampers which activate automatically to prevent drafts while the unit is off.



## CASING

Polymer coated metal casing decorated with an acrylic front panel. Due to modern design, the unit matches well with any interior. Heat and sound insulation is ensured by a layer of 10 mm cellular synthetic rubber. The front panel provides convenient access for filter maintenance and has a lock for extra security. The unit has two  $\varnothing$  100 mm spigots for fresh air intake and stale air extraction outside. The third  $\varnothing$  100 mm spigot (included in the delivery set) can be additionally fitted to the unit to connect the extract air duct from the bathroom.



## RECIRCULATION DAMPER



## FREEZE PROTECTION

The MICRA 200 ERV WiFi features an exhaust air temperature sensor downstream of the heat exchanger which disables the supply fan to let the warm extract air warm up the heat exchanger. Then the supply fan is turned on and the unit reverts to normal operation. Freeze protection for the MICRA 200 E ERV WiFi and MICRA 200 E2 ERV WiFi units is implemented with a preheater.



**CONTROL UNIT**



**SUPPLY FILTERS**

F8 + H13 (option)



**G4 EXTRACT FILTER**

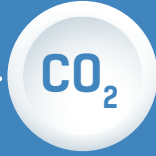

**CO<sub>2</sub>**

**CO<sub>2</sub> SENSOR (OPTION)**

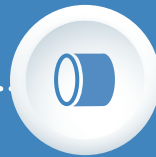

**ADDITIONAL SPIGOT**

For air extraction from the bathroom.



**HEAT EXCHANGER**

The MICRA 200 ERV WiFi unit is equipped with an enthalpy counter-flow heat exchanger. In the cold season the extract air heat and moisture are transferred to the supply air stream through the enthalpy heat exchanger reducing the heat losses through ventilation. The ambient air heat and moisture are transferred to the extract air through the enthalpy heat exchanger in the warm season. This allows for a considerable reduction of the supply air temperature and humidity which, in turn, reduces the air conditioning load.

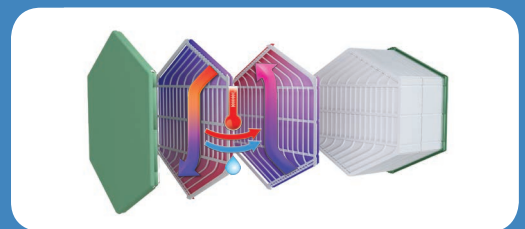

**G4 INTAKE FILTER**



**PREHEATER**

The MICRA 200 E ERV WiFi and MICRA 200 E2 ERV WiFi units are equipped with an electric preheater which protects the heat exchanger from freezing.

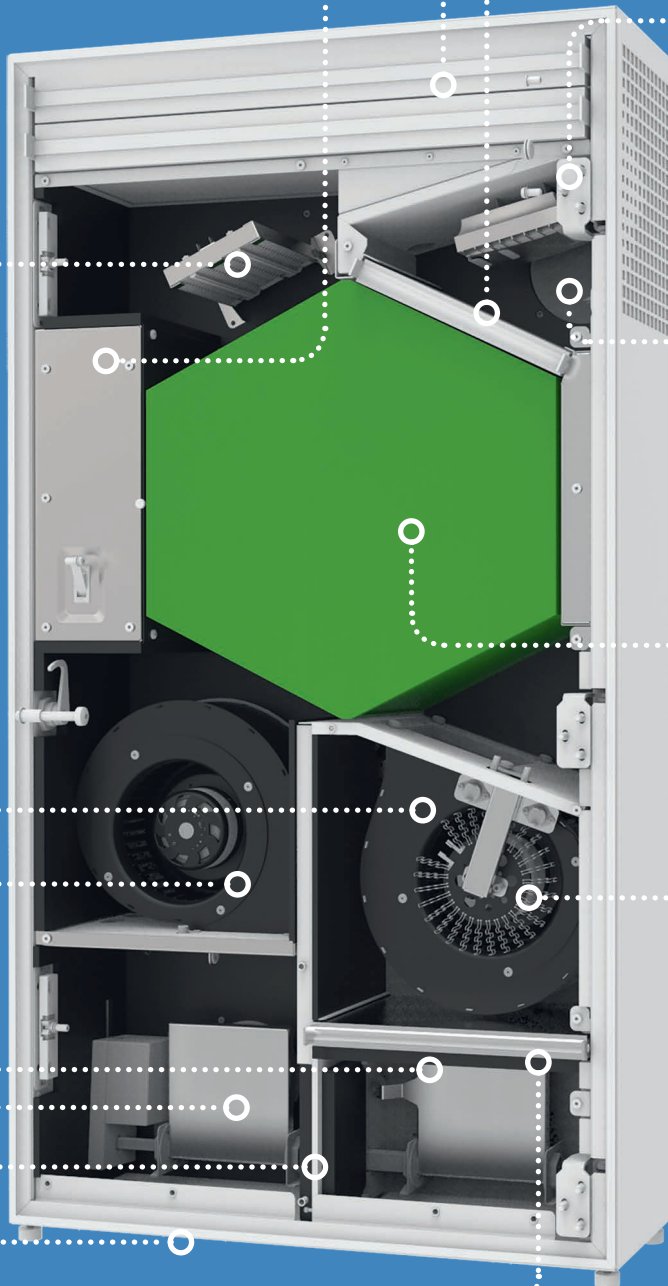

# TECHNICAL DATA

**ENERG** Y IJA  
енергия · ενεργεια  
IE IA

**VENTS MICRA 200 ERV WiFi**

**A+**  
**A** ← **A**  
**B**  
**C**  
**D**  
**E**  
**F**  
**G**

**39 dBA**

**200 m³/h**

ENERGIA · ΕΝΕΡΓΙΑ · ΕΝΕΡΓΕΙΑ · ENERGIJA · ENERGY · ENERGIE · ENERGI  
**2018** **1254/2014**

MICRA 200 ERV WiFi						
Specific energy consumption (SEC) [kWh/(m <sup>2</sup> .a)]	Cold		Average		Warm	
		-70.5	A+	-35.9	A	-13.5
Type of ventilation unit	Bidirectional					
Type of drive installed	With variable rotation frequency					
Type of heat recovery system	Regenerative					
Thermal efficiency of heat recovery [%]	68					
Maximum flow rate [m <sup>3</sup> /h]	200					
Power [W]	125					
Sound power level [dBA]	39					
Reference flow rate [m <sup>3</sup> /s]	0.039					
Reference pressure difference [Pa]	N/A					
Specific power input (SPI) [W/m <sup>3</sup> /h]	0.366					
Control typology	Local demand control					
Maximum internal leakage rates [%]	0.1					
Maximum external leakage rates [%]	0.9					
Mixing rate of bidirectional units [%]	20					
Airflow sensitivity at +20 Pa and -20 Pa	0.93					
The indoor/outdoor air tightness [m <sup>3</sup> /h]	7					
Internet address	<a href="http://www.ventilation-system.com">http://www.ventilation-system.com</a>					
The annual electricity consumption (AEC) [kWh electricity/a]	Cold	Average	Warm			
	795	258	213			
The annual heating saved (AHS) [kWh primary energy/a]	Cold	Average	Warm			
	8161	4172	1886			

	MICRA 200 ERV WiFi					MICRA 200 E ERV WiFi					MICRA 200 E1 ERV WiFi					MICRA 200 E2 ERV WiFi				
	1	2	3	4	5	1	2	3	4	5	1	2	3	4	5	1	2	3	4	5
Speed	1~ 220-240																			
Unit voltage [V/50 (60) Hz]	1~ 220-240																			
Maximum unit power without an electric heater [W]	10	15	25	44	134	10	15	25	44	134	10	15	25	44	134	10	15	25	44	134
Electric preheater power [W]						650										650				
Electric reheater power [W]											700					700				
Maximum unit current (with a heater) [A]	1.0					4.0					4.2					7.2				
Maximum flow rate [m <sup>3</sup> /h]	30	60	90	120	200	30	60	90	120	200	30	60	90	120	200	30	60	90	120	200
RPM [min <sup>-1</sup> ]	2000																			
Insulation [mm]	12	22	30	36	45	12	22	30	36	45	12	22	30	36	45	12	22	30	36	45
Transported air temperature [°C]	From -15 up to +40																			
Casing material	Polymer-coated steel																			
Insulation [mm]	30																			
Extract filter	G4																			
Supply filter	G4 + F7 Option: H13																			
Connected air duct diameter [mm]	100																			
Weight [kg]	55																			
Heat recovery efficiency [%]*	85	81	75	68	66	85	81	75	68	66	85	81	75	68	66	85	81	75	68	66
Heat exchanger type	Counter-flow																			
Heat exchanger material	Enthalpy																			
SEC class	A																			

\*Heat recovery efficiency is specified in compliance with EN 13141-8.

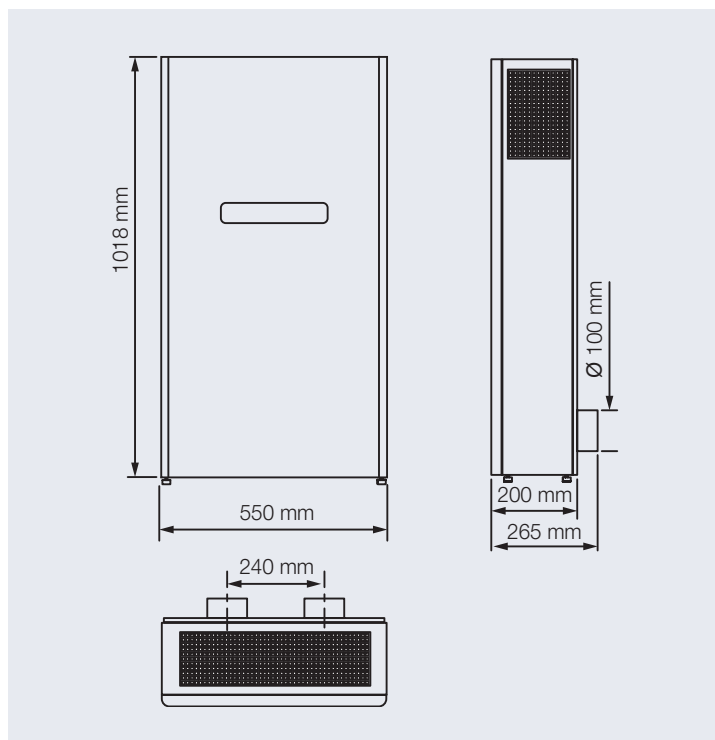
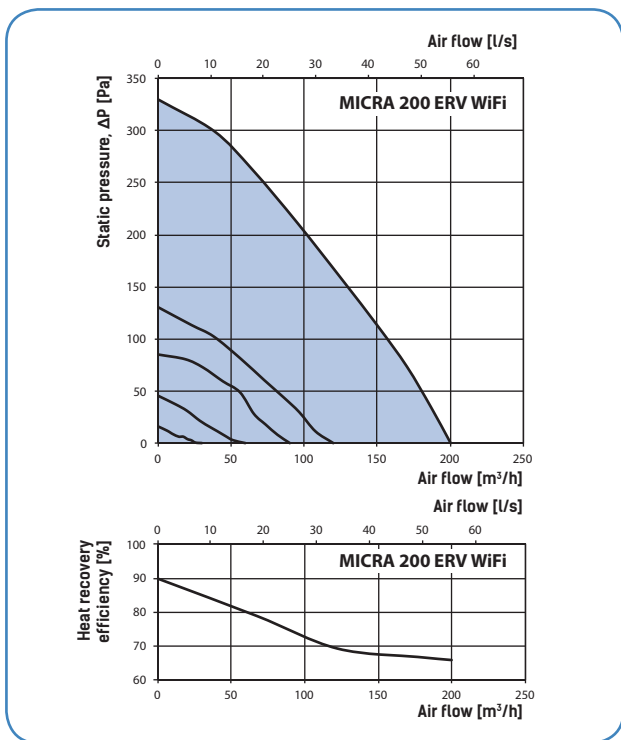

## ACCESSORIES



NB MICRA 200 white  
Outdoor box (white)

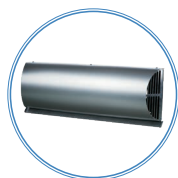

NB MICRA 200 chrome  
Brushed stainless steel  
outdoor box

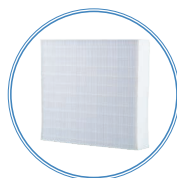

SF 201x162x20 G4  
G4 panel filter

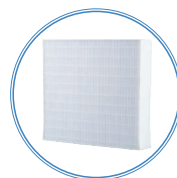

SF 243x162x20 G4  
G4 panel filter

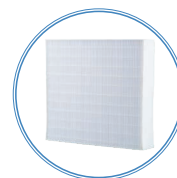

SF 502x162x40 F7  
F7 panel filter



MICRA 200 white mounting kit:

- two plastic  $\varnothing$  100 mm air ducts 500 mm long
- outdoor box (white)
- cardboard template

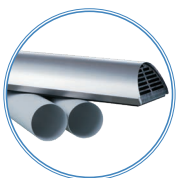

MICRA 200 chrome mounting kit:

- two plastic  $\varnothing$  100 mm air ducts 500 mm long
- outdoor box (white)
- cardboard template

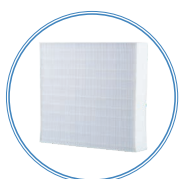

SF 502x162x40 H13  
H13 panel filter



CO<sub>2</sub>-1  
CO<sub>2</sub> sensor with air quality  
indication and On/Off button



CO<sub>2</sub>-2  
CO<sub>2</sub> sensor



# VENTILATION SYSTEM ARRANGEMENT

Each space requiring proper ventilation should be equipped with a single or several MICRA 200 ERV WiFi units. A single unit is capable of ensuring efficient ventilation in spaces with floor area up to 100 m<sup>2</sup>.

The MICRA 200 ERV WiFi units can be upgraded with a bathroom extract air duct. For this, the units can be additionally equipped with an optional  $\varnothing$  100 mm spigot (included in the delivery set).

## MICRA 200 ERV WiFi application in an office space

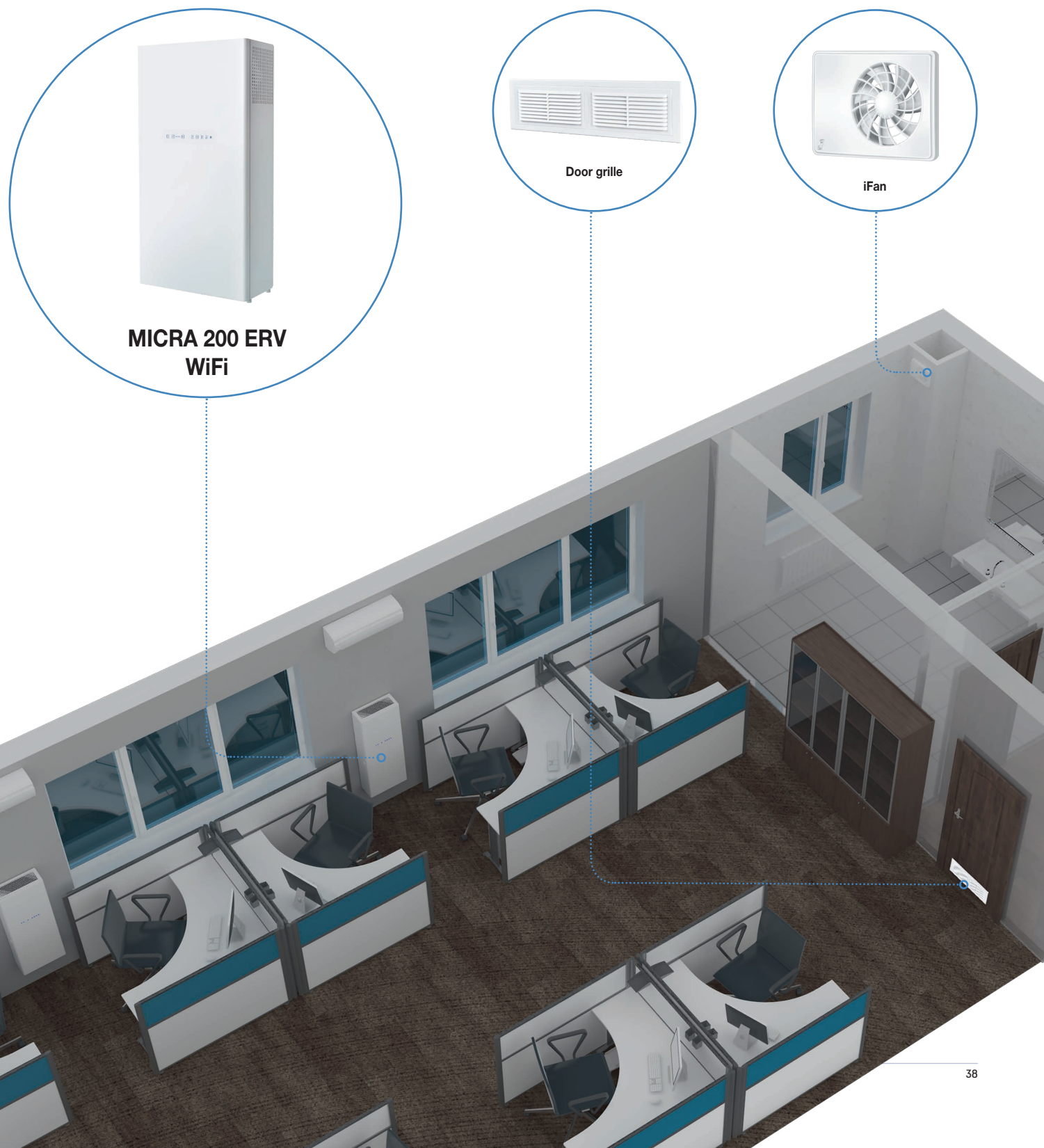

The MICRA 200 ERV WiFi application in a compact residential space

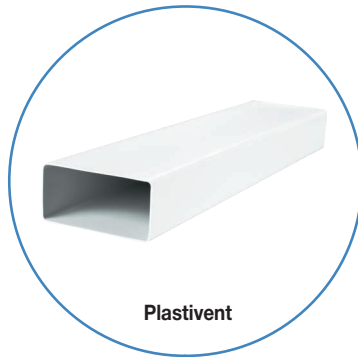

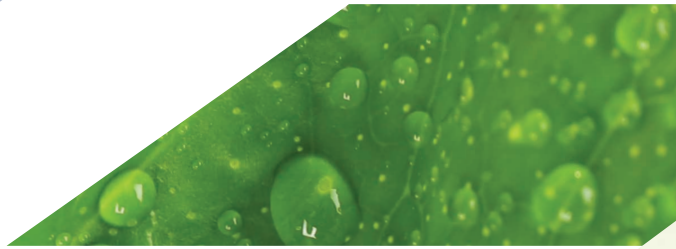

The catalogue information is for reference only.

VENTS reserves the rights to modify any of its products' features, designs, components and specifications at any time and without notice to maintain the development and quality of manufactured goods.

[ventilation-system.com](http://ventilation-system.com)

05 | 2020