

# USER'S MANUAL

---

PU SENS 01 (A11)  
PU SENS 01 (A19)



Sensor Control Panel

## CONTENTS

Safety requirements.....	3
Purpose.....	4
Technical data.....	4
Mounting and set-up.....	5
Battery replacement.....	6
Control panel operation.....	7
Control panel .....	7
1. Main menu .....	7
2. Unit activation and deactivation .....	7
3. Fan speed changeover.....	8
4. Temperature setting .....	9
5. User menu .....	9
6. Engineering menu.....	10
7. Air flow setting.....	11
8. Temperature sensor .....	11
9. Language selection.....	11
10. Additional options .....	12
11. Password change.....	13
12. Standby mode setting.....	13
13. Display brightness adjustment.....	13
14. Humidity setting .....	14
15. Error control .....	14
16. Control panel temperature sensor correction.....	15
17. Default settings.....	15
18. Current temperature review.....	15
19. AUTO mode (scheduled operation).....	16
20. Date and time.....	17
21. Timer .....	18
22. Motor hours .....	19
23. Errors.....	20
Error code description.....	21
Factory settings .....	22

This user's manual is a main operating document intended for technical, maintenance, and operating staff.

The manual contains information about the purpose, technical details, operating principle, design, and installation of the PU SENS 01 unit (-s) and all of its (their) modifications.

Technical and maintenance staff must have theoretical and practical training in the field of ventilation systems and should be able to work in accordance with workplace safety rules as well as construction norms and standards applicable in the territory of the country.

The information in this user's manual is correct at the time of the document's preparation.

The Company reserves the right to modify the technical characteristics, design, or configuration of its products at any time in order to incorporate the latest technological developments.

No part of this publication may be reproduced, stored in a retrieval system, or transmitted, in any form or by any means in any information search system or translated into any language in any form without the prior written permission of the Company.

## SAFETY REQUIREMENTS

- Please read the user's manual carefully prior to installing and operating the unit.
- All user's manual requirements as well as the provisions of all the applicable local and national construction, electrical, and technical norms and standards must be observed when installing and operating the unit.
- The warnings contained in the user's manual must be considered most seriously since they contain vital personal safety information.
- Failure to follow the rules and safety precautions noted in this user's manual may result in an injury or unit damage.
- After a careful reading of the manual, keep it for the entire service life of the unit.
- While transferring the unit control, the user's manual must be turned over to the receiving operator.

### UNIT MOUNTING AND OPERATION SAFETY PRECAUTIONS



- Disconnect the unit from power mains prior to any installation operations.



- Do not operate the unit outside the temperature range stated in the user's manual.
- Do not operate the unit in aggressive or explosive environments.



- Do not lay the power cable of the unit in close proximity to heating equipment.



- While installing the unit follow the safety regulations specific to the use of electric tools.



- Do not change the power cable length at your own discretion.
- Do not bend the power cable.
- Avoid damaging the power cable.
- Do not put any foreign objects on the power cable.



- Unpack the unit with care.

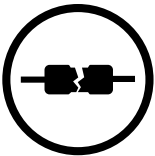

- Do not use damaged equipment or cables when connecting the unit to power mains.



- When the unit generates unusual sounds, odour or emits smoke disconnect it from power supply and contact the Seller.



- Do not touch the unit controls with wet hands.
- Do not carry out the installation and maintenance operations with wet hands.

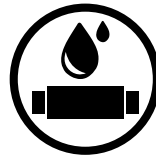

- Do not wash the unit with water.
- Protect the electric parts of the unit against ingress of water.



- Do not allow children to operate the unit.

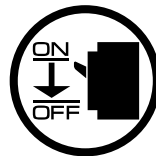

- Disconnect the unit from power mains prior to any technical maintenance.



**THE PRODUCT MUST BE DISPOSED SEPARATELY AT THE END OF ITS SERVICE LIFE.  
DO NOT DISPOSE THE UNIT AS UNSORTED DOMESTIC WASTE.**

## PURPOSE

The sensor control panel is designed to control domestic and industrial air handling units as well as other air processing units. It is rated for continuous operation.



**THE UNIT SHOULD NOT BE OPERATED BY CHILDREN OR PERSONS WITH REDUCED PHYSICAL, MENTAL, OR SENSORY CAPACITIES, OR THOSE WITHOUT THE APPROPRIATE TRAINING.**

**THE UNIT MUST BE INSTALLED AND CONNECTED ONLY BY PROPERLY QUALIFIED PERSONNEL AFTER THE APPROPRIATE BRIEFING.**

**THE CHOICE OF UNIT INSTALLATION LOCATION MUST PREVENT UNAUTHORIZED ACCESS BY UNATTENDED CHILDREN.**

## TECHNICAL DATA

### PARAMETER

Ambient temperature [°C]  
Relative humidity [%]  
Cable cross section [mm<sup>2</sup>]  
Material  
Dimensions (WxHxD) [mm]  
Cable length [m]  
Ingress protection

### VALUE

+5... +40  
5...80 (no condensation)  
0.25...0.75  
plastic  
130x86x30  
10...30  
IP20

### Overall dimensions [mm]

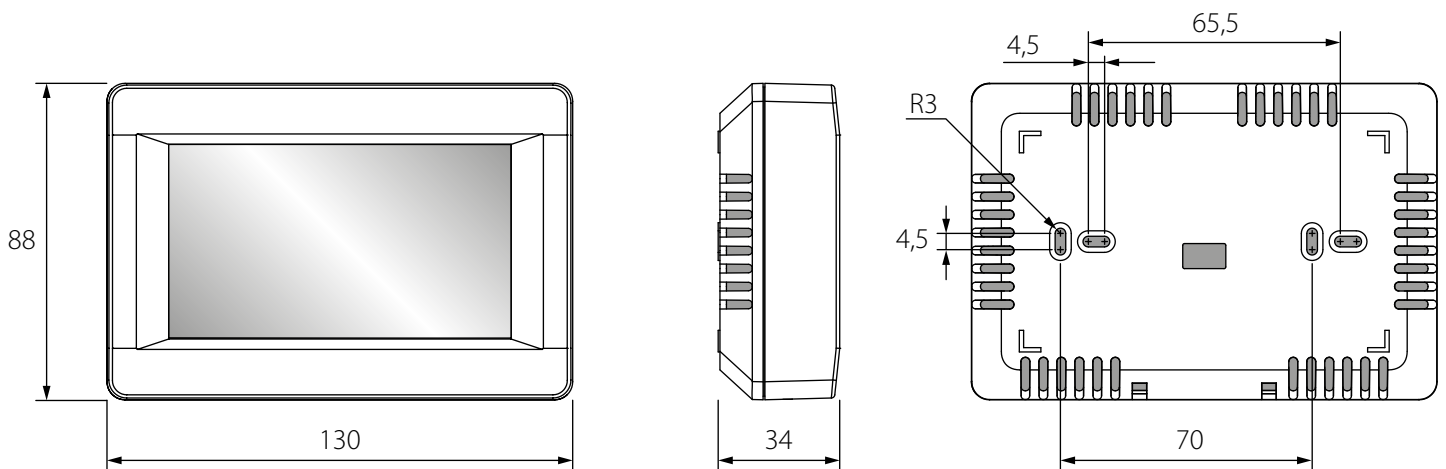

**MOUNTING AND SET-UP**



**READ THE USER'S MANUAL BEFORE INSTALLING THE UNIT.**



**DO NOT LAY THE CABLE IN CLOSE PROXIMITY TO THE CONTROL PANEL CABLE!  
WHILE ROUTING THE CONTROL PANEL CABLE DO NOT COIL THE EXTRA LENGTH.**

**RECOMMENDED CROSS-SECTIONS OF THE CABLE CONNECTING THE CONTROL PANEL TO THE UNIT**

Cable cross section	≥ 0.25 mm <sup>2</sup>	≥ 0.5 mm <sup>2</sup>	≥ 0.75 mm <sup>2</sup>
Cable length	up to 10 m	up to 20 m	up to 30 m

**Control panel mounting sequence**

- Make a recess in the wall for a mounting box and lay the cable from the air handling unit.

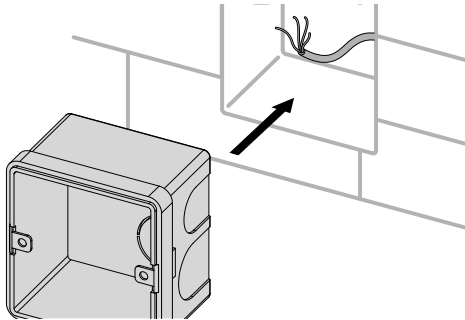

- Remove the screws on the panel edge.

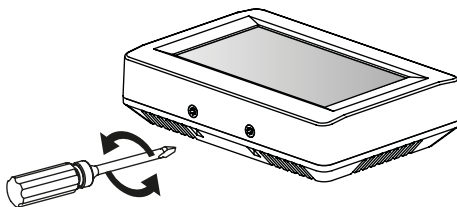

- Pass the cable into the rectangular opening on the back part of the control panel and fix the panel on the mounting box.

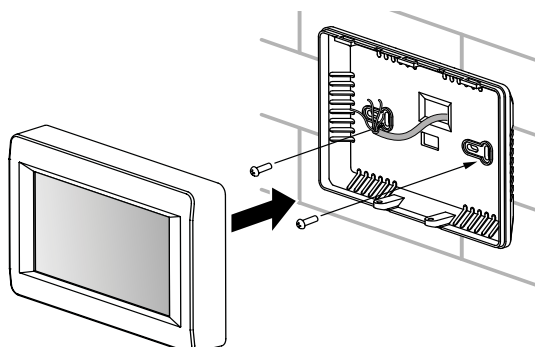

- Install the mounting box.

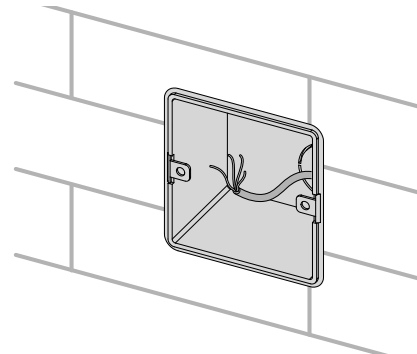

- Disassemble the panel by separating the frontal part from the back part.

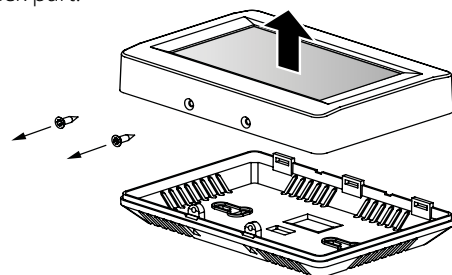

- Connect the cable to the control board and install the frontal part of the panel using the screws.

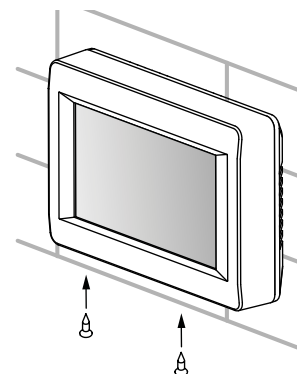

### Battery replacement

The battery keeps the internal clock running while the unit is disconnected from power supply.

If the unit is disconnected from power supply and the battery is low, the clock stops and the day and time settings are reset. This leads to incorrect date and time indication when the unit is on and, as a result, to incorrect scheduled operation of the unit. In this case, the battery should be replaced.

To replace the battery, use a new battery only.

1. Disconnect the unit from power supply.
2. Remove two screws in the bottom part of the casing.

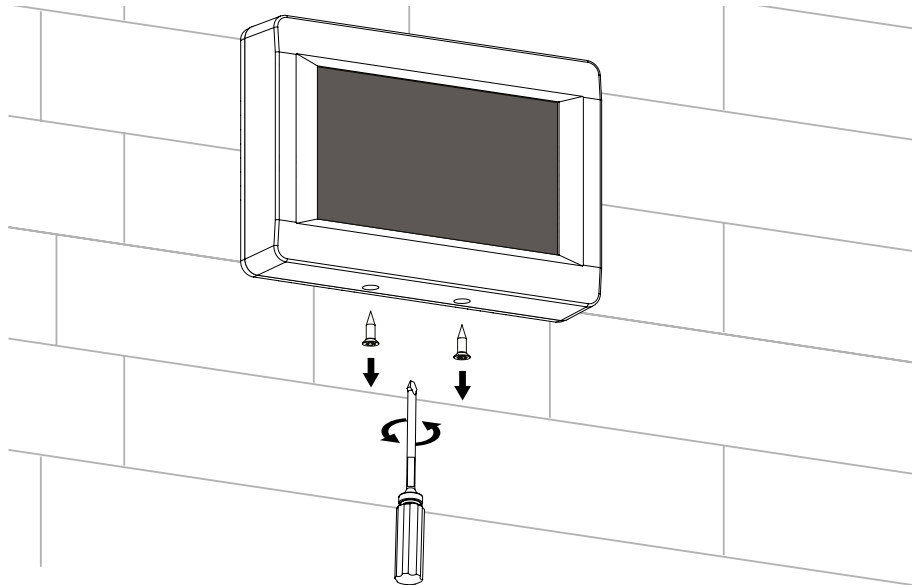

3. Pull the top part of the casing aside to allow access to the upper circuit board. Replace the battery. The control panel uses a **CR1220** lithium battery.

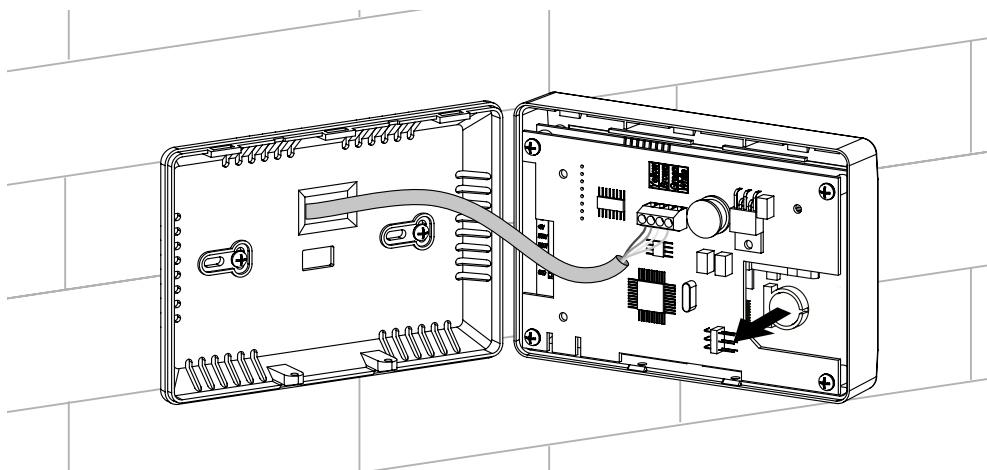

4. Assemble the control panel in the reverse order. If the terminal block wires on the upper circuit board were unplugged, make sure to reconnect them correctly. Failure to reconnect the wires properly may knock the equipment out of service.
5. Connect the panel to the power supply and set the current date and time.

## CONTROL PANEL OPERATION

### Control panel

Ventilation units are controlled via a sensor control panel.  
The Main menu is shown after switching on the control panel.

#### 1. Main menu



The Main menu contains the date, current humidity, time, temperature and set air flow. This menu also works as a hub for accessing the main control panel functions and menus.

**MENU** — access to the User menu, see para. 5.

**AUTO** — scheduled operation activation/deactivation.

**TEMPERATURE** — display of the current indoor temperature.

After pressing this button the Temperature Setting menu is opened, see para. 4.

**ON/ OFF** — turning the unit on/off.

**TIMER** — turning the timer on/off.

**AIR FLOW** — current fan speed display. The Fan Speed Setting menu is accessible through this button, see para. 3.

#### Control priorities:



1. Timer: When the timer is active, the unit switches to the timer-scheduled operation and ignores the schedule settings (**AUTO** mode) and manual control settings (**AIR FLOW** and **TEMPERATURE**).
2. Auto: When the **AUTO** mode is active, the unit switches to scheduled operation and ignores manual control settings of air flow and temperature, provided that the timer is off.
3. Manual control settings of air flow and temperature: If the **TIMER** and **AUTO** modes are off, the unit operates in accordance with manual control settings of air flow and temperature.

#### Example 1 for unit operation in accordance with control priorities:

1. The **AUTO** mode is on, the unit follows the schedule: the 2nd speed in accordance with schedule settings.
2. The user activates the timer by pushing the appropriate button. The unit switches to the **TIMER** mode: the 3rd speed during 4 hours in accordance with timer settings.
3. When 4 hours of timer-scheduled operation expire, the timer turns off and the unit switches to the scheduled operation mode automatically: the 2nd speed in accordance with schedule settings.

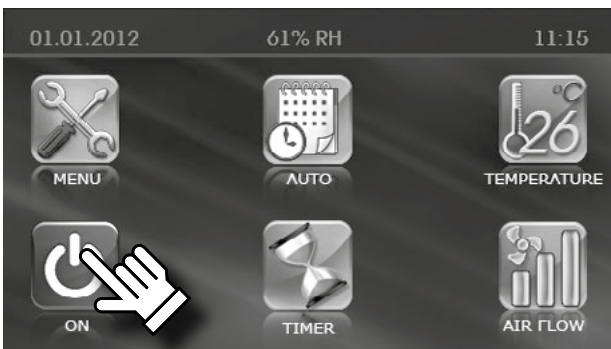
#### 2. Unit activation and deactivation





- The unit is switched on/off using the ON  (green colour) / OFF  (red colour) buttons.

Upon deactivation of the ventilation unit the icon changes from green to red.



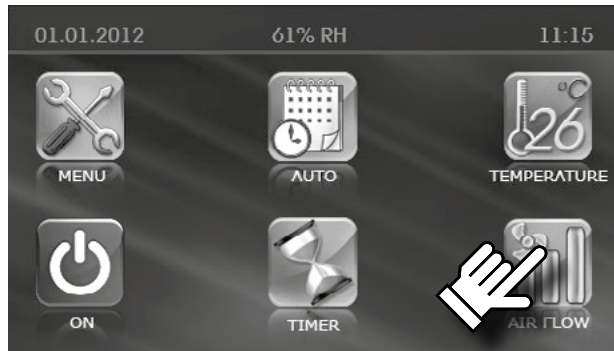

The STANDBY mode parameters are set in the Engineering menu (see para. 12).

### 3. Fan speed changeover







- Press the AIR FLOW  button to select the desired fan speed.

The unit has four speed stages:

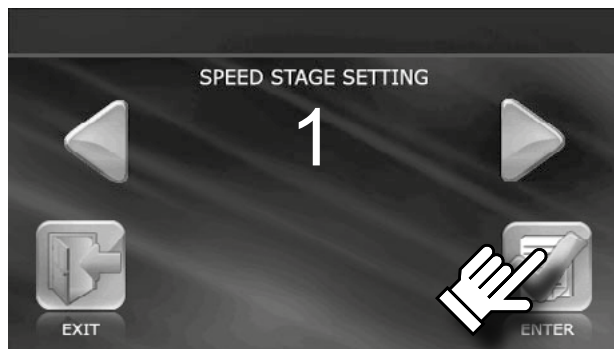
-  — first speed
-  — second speed
-  — third speed
-  — humidity control mode. The fan speed is regulated depending on the humidity setting. The unit does not provide additional built-in humidifiers or dehumidifiers. If the room humidity is higher than the set level, the unit slowly increases the speed. If the room humidity is lower than the set level, the unit slowly decreases the speed. In this way, the humidity is maintained at the set level. The humidity level is set via the Engineering menu, see para. 14.

- If the **AUTO** or **TIMER** mode is activated, the current airflow value is displayed in real time operation no matter of the air flow value set by means of the **AIR FLOW** button.





- Set the required speed using  or .
- Then press **ENTER** .
- To return to the Main menu without saving changes, press **EXIT** .



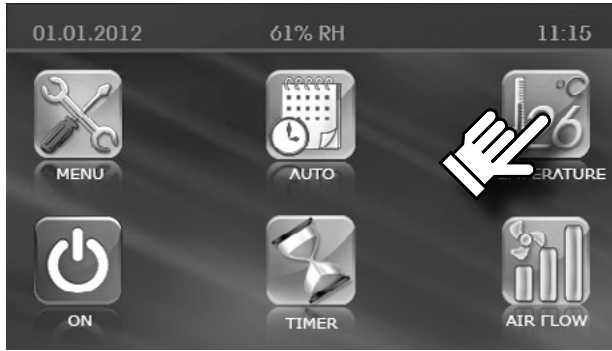



#### 4. Temperature setting

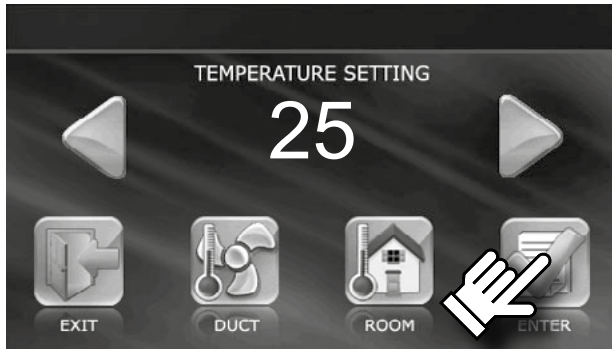

- Press the **TEMPERATURE** button .
- Select the set temperature type: **DUCT**  (temperature in the air duct) **ROOM**  (temperature in the room).



- Then use  and  to set the desired temperature parameter value.
- Press ENTER  to save the set parameter.
- To return to the Main menu without saving changes, press EXIT .

#### 5. User menu



- To enter the User menu, press MENU  in the control panel Main menu.

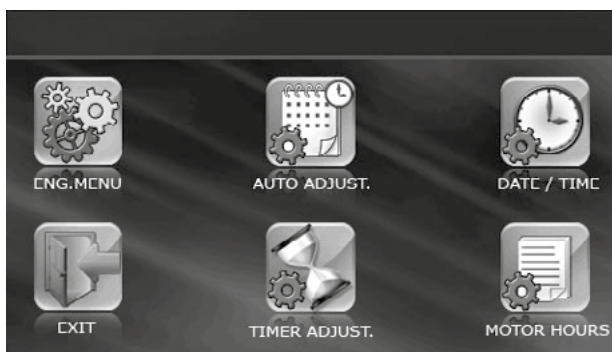

- The User menu contains basic menu items and functions for parameters setting:

- ENG. MENU** — access to the Engineering menu. The menu is password-protected.
- AUTO ADJUST.** — scheduled operation setting.
- DATE AND TIME** — date and time setting.
- TIMER ADJUST.** — setting time and speed operation on timer basis.
- MOTOR HOURS** — setting filter replacement periodicity.
- EXIT** — return to the Main menu.

## 6. Engineering menu

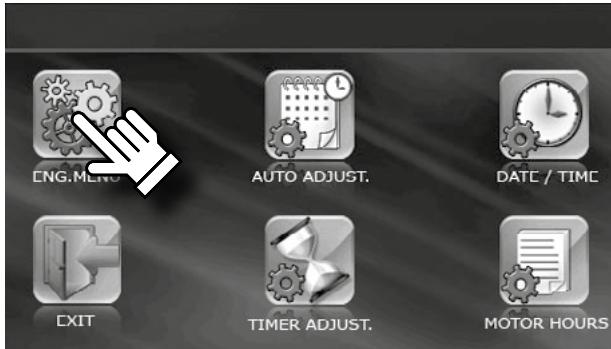

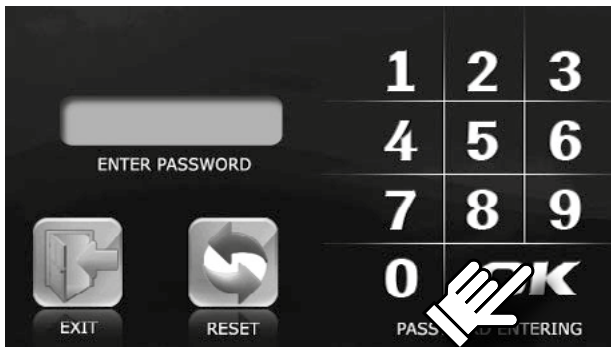

• To enter the Engineering menu, press **ENG. MENU**  in the User menu.



- Enter the password (1111 by default).
- Press OK.





If the incorrect password is entered, press **RESET**  and enter the password again.

- To return to the Engineering menu, press **EXIT** .
- If you forgot the user-defined password, see para. 11 Password Change,

press and hold **RESET**  until you hear a long sound signal (20 clicks, approximately 20 seconds).

- The default password 1111 is set.

### For navigating in the Engineering menu use the following buttons:

-  — moving upwards in the list
-  — moving downwards in the list
-  — select the value from the parameter list
-  — return to the User menu

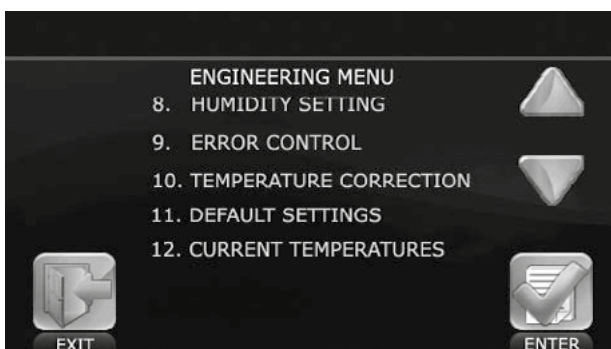
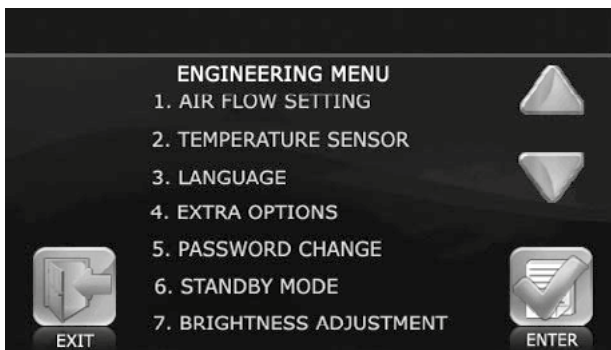

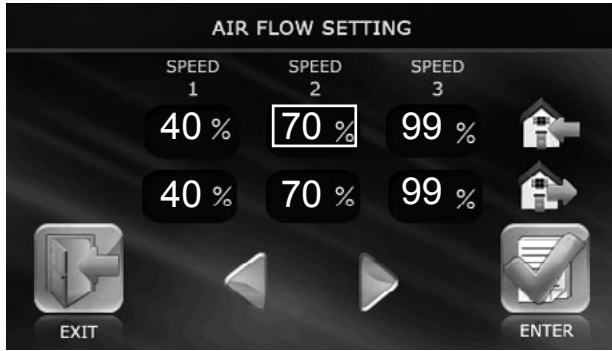

## 7. Air flow setting



- Select the **AIR FLOW SETTING** item from the Engineering menu and press **ENTER** .

- Select the edited speed value (the selected value is highlighted with a rectangle).

- Use  or  buttons to set the air flow value for each fan speed stage.

- The air flow is set as a percentage of the maximum performance of each fan.

- To return to the Engineering menu without saving changes, press



## 8. Temperature sensor

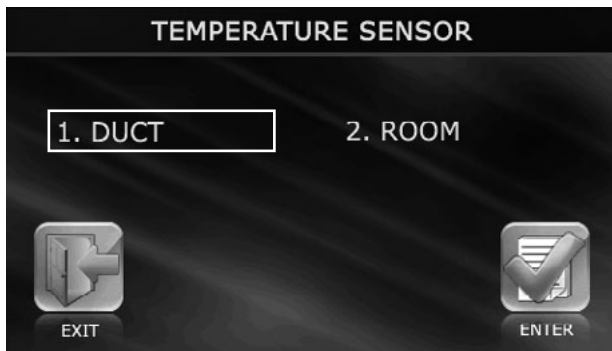

- To select the heating control sensor from the Engineering menu, select the

- TEMPERATURE SENSOR** submenu and press **ENTER** .

- Select a desired sensor type.

- Press **ENTER**  to confirm.

- To return to the Engineering menu without saving changes, press



*The duct temperature sensor is installed in the supply air duct downstream of the heat exchanger.*

*The room temperature sensor is integrated in the control panel.*

## 9. Language selection



- To select the control panel interface language, select the **LANGUAGE**

- submenu from the Engineering menu and press **ENTER** .

- Select the desired language from the list.

- Press **ENTER**  to confirm.

- To return to the Engineering menu without saving changes, press



## 10. Additional options



- Select the **EXTRA OPTIONS** item in the Engineering menu and press

**ENTER**

- **HEATING CONTROL** activates automatic switching on/off of the heater. When activating the **HEATING CONTROL MODE** turn off the **SUPPLY FAN OFF MODE** by selecting the **OFF** button.

- The **SUPPLY FAN OFF MODE** activates the heat exchanger freeze protection and can only be activated when the **HEATING CONTROL** option is **OFF**.

To activate the heat exchanger freezing protection function by means of the supply fan deactivation, set the **HEATING CONTROL** parameter value to **OFF**.

To proceed to the mode settings set the **SUPPLY FAN OFF MODE** parameter to **ON**.

- **HUMIDITY SENSOR SELECTION** - selection of the humidity sensor for controlling the unit.

1 — the sensor is installed in the extract air duct upstream of the heat exchanger.

2 — the sensor is installed indoors.

- **BYPASS OPERATION MODES:**

1 — set temperature maintenance in the warm season (at a temperature above +15 °C) in the cold season (at a temperature below +15 °C) bypass is closed but it protects the heat exchanger from freezing by opening at a temperature below +3 °C in the exhaust air duct downstream of the heat exchanger.

2 — positive bypass opening for natural ventilation at outdoor temperature above +15 °C.

**WARNING:** It is not recommended to use the manual bypass mode (2) during the winter period to prevent room overcooling.

Only **AUTO** mode (1) should be used during the winter period.



- To save the changes and return to the Engineering menu, press

- If the **SUPPLY FAN OFF MODE** parameter is set to **ON**, the control panel switches to the **SUPPLY FAN OFF MODE** setting.

- Select an item by touching the respective field: **WORKING HOURS**, **DOWNTIME** and **SWITCH-OFF TEMPERATURE** (the temperature is set according to the outdoor temperature sensor readings defined in the range from +10 °C to -20 °C).

- Then use and to set the desired value.

- Press **ENTER** to confirm the set parameters.

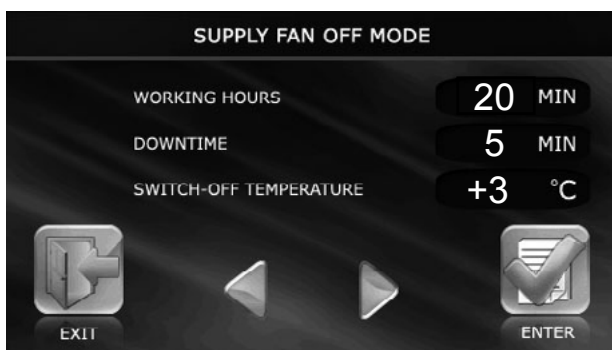

- To return to the Engineering menu without saving changes, press

**EXIT**



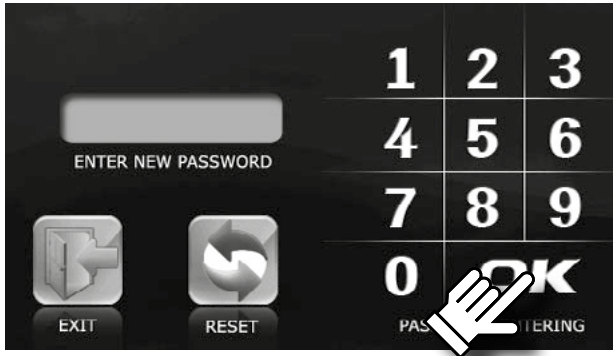



### 11. Password change



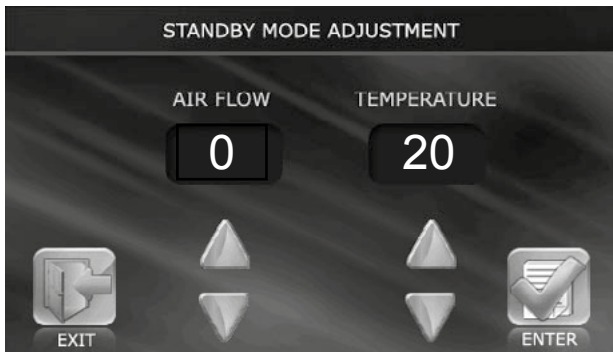

- Select the **PASSWORD CHANGE** submenu from the Engineering menu and press **ENTER** .
- Then enter the new password for accessing the Engineering menu.
- Press **OK**.
- When the incorrect password is entered, press **RESET** and enter the password again.
- To return to the Engineering menu, press **EXIT** .

### 12. Standby mode setting







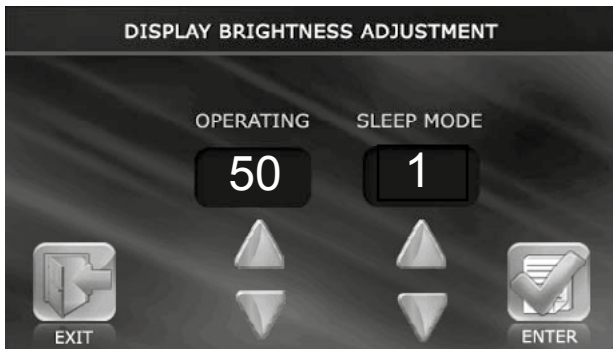

- Select the **STANDBY MODE** item in the Engineering menu and press **ENTER** .
- Then use the  or  buttons to select:  
0 — deactivation of the unit  
1 — standby mode

While in the Standby mode the ventilation unit runs at the first speed at the pre-set temperature.

- Press **ENTER**  to confirm.
- To return to the Engineering menu without saving changes, press **EXIT** .

### 13. Display brightness adjustment



- Select the **BRIGHTNESS ADJUSTMENT** submenu from the Engineering menu and press **ENTER** .
- Then use the  or  to set the brightness for the **OPERATION** and **SLEEP** modes. The panel switches to the **SLEEP** mode 30 seconds after the last screen interaction.
- Press **ENTER**  to confirm.
- To return to the Engineering menu without saving changes, press **EXIT** .



## 14. Humidity setting



- Select the **HUMIDITY SETTING** item in the Engineering menu and press

**ENTER** .

- Then select the humidity control location:

**DUCT**  — the humidity level is controlled in the extract duct upstream of the heat exchanger.

Make sure that a duct humidity sensor is included in the scope of delivery to control duct humidity.

**ROOM**  — the humidity level is controlled in the room where the control panel is installed.

The control panel is equipped with a humidity sensor.

- Then use  or  to set the desired humidity level.

- Press **ENTER**  to confirm.

- To return to the Engineering menu without saving changes, press

**EXIT** .

*In the HUMIDITY CONTROL mode the minimum air flow is equal to the air flow at the low speed.*

## 15. Error control

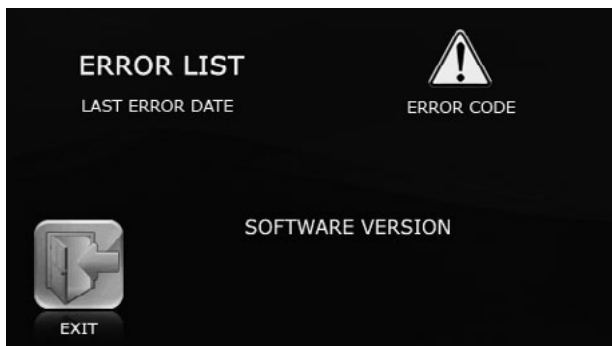

- To receive information regarding the last error, select ERROR CONTROL

submenu from the Engineering menu and press **ENTER** .

- The display shows the error date and code.

• To return to the Engineering menu, press **EXIT** .

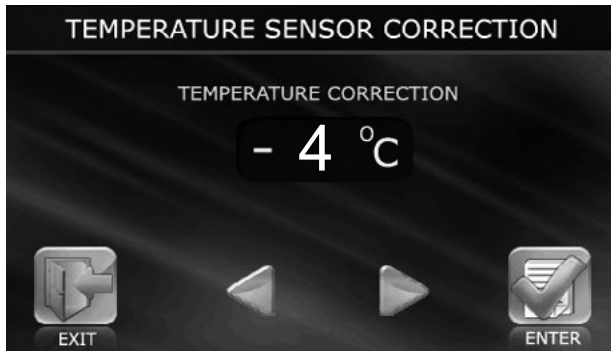

- Errors description is stated in the respective table below.

## 16. Control panel temperature sensor correction



- To correct the panel temperature sensor indications, select **TEMPERATURE CORRECTION** submenu from the Engineering menu and press

**ENTER** 

- Then use the  or  buttons to set the temperature correction for the room temperature sensor installed in the control panel casing.

The default factory setting for the temperature sensor correction is **-4 °C**.

Correction is necessary to compensate sensor errors caused by heating of control panel internal elements.

- To return to the Engineering menu without saving changes, press

**EXIT** 

## 17. Default settings



- To reset the controller settings to the factory defaults, select **DEFAULT**

**SETTINGS** submenu from the Engineering menu and press **ENTER** 

- Press **ENTER**  to confirm the reset.
- To return to the Engineering menu without saving changes, press

**EXIT** 

- The default settings are given in the table below.

## 18. Current temperature review

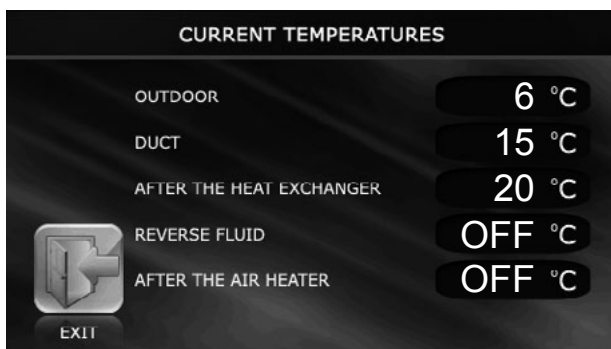

- Select the **CURRENT TEMPERATURES** item in the Engineering menu and press **ENTER** 

- The display will show the current temperature sensor readings:

**OUTDOOR** — readings of the temperature sensor installed outdoors or in the outdoor air duct upstream of the heat exchanger.

**DUCT** — readings of the temperature sensor installed in the supply duct downstream of the heat exchanger.

**AFTER THE HEAT EXCHANGER** — readings of the temperature sensor installed in the extract duct downstream of the heat exchanger.

**REVERSE FLUID** — return heat medium temperature sensor readings.

**AFTER THE AIR HEATER** — readings of the temperature sensor installed in the supply duct downstream of the water heater.

- If any temperature sensor of the ventilation unit is missing, its configuration value is displayed as **OFF**.

To return to the Engineering menu, press **EXIT** 

### 19. AUTO mode (scheduled operation)

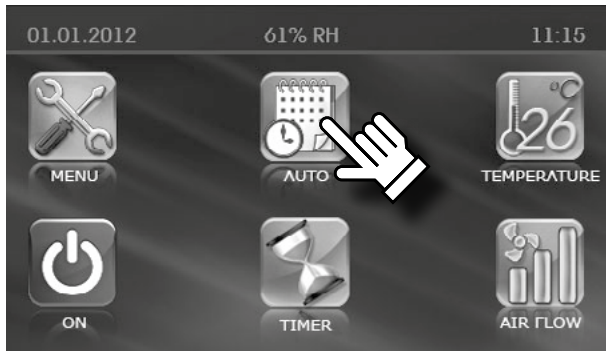

The **AUTO** mode enables scheduled operation of the ventilation unit. The unit runs at the preset speed and temperature during the specified time periods.

The unit is in the **STANDBY** mode between the operating periods.

To activate the **AUTO** mode, press the **AUTO** button  in the Main menu.

Activation of the **AUTO** mode is confirmed with a tick .

*The **AUTO** mode has a higher priority than manual control settings of air flow and temperature but lower priority than the **TIMER** mode. When the **TIMER** mode is activated the **AUTO** mode is inactive.*

*When the **AUTO** mode is active, the unit switches to scheduled operation and ignores manual control settings of air flow and temperature, provided that the timer is off.*

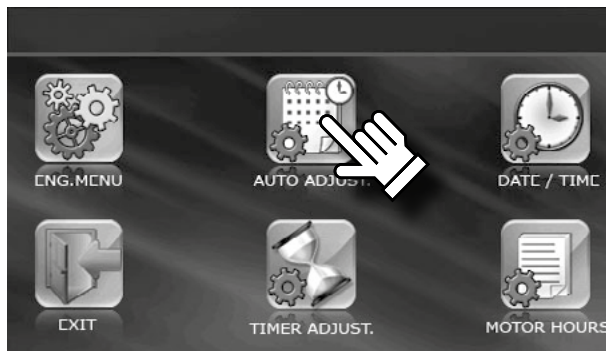



To set up the **AUTO** mode, press the  button to enter the User

menu, see para. 5, and press **AUTO ADJUST** .

	PERIOD	AIR FLOW	TEMPERATURE
▲	8 : 00 - 12 : 00	1	21
	13 : 00 - 15 : 00	2	15
▼	16 : 00 - 18 : 00	2	15
	18 : 00 - 23 : 00	3	18
EXIT	23 : 00 - 7 : 00	1	24
	8 : 00 - 12 : 00	2	15

Select the day to enable the **AUTO** mode. Upon entering the menu the value is set to the current day. To change the day, press the **DAY** field.

Then use the  or  buttons to set the time, air flow and temperature for the selected day by pressing the respective parameter field.

Depending on the **STANDBY** mode settings, the unit remains in the **STANDBY** mode or turns off between the operating periods.

To return to the Engineering menu and save changes automatically, press

**EXIT** .



The date and time on the control panel must be set correctly (described in the present manual).

- The unit operation schedule is programmed for each day of the week individually.
- The schedule contains 6 lines with parameters for setting the operating modes within one day. To select the other day of the week, click on the day of the week in the upper right corner of the screen.
- Each schedule line can contain any time values, but within one day.

The initial value of the time in the line (the one on the left) should not exceed the finite time interval (the one on the right). Otherwise, the difference in these intervals will be negative and the AUTO mode will not work.

- If the time intervals of different schedule lines overlap in time, the priority will be given to the line that is listed lower.

**Example:**

1st line 10:00 - 12:00 1 20  
2nd line 11:00 - 13:00 2 20

In the interval from 10:00 to 11:00, the unit will operate at the first speed, and from 11:00 will switch to the second speed, since the lower line has a higher priority than the top line.

- If there are temporary breaks between different lines of the schedule, the unit will operate in the **STANDBY** mode in these time intervals (between lines).
- If "0" is set in the **STANDBY** mode settings, the unit will turn off. If "1" is set in the **STANDBY** mode settings, then the unit will operate at minimum speed.



**Example:**

1st line 10:00 - 12:00 1 20  
2nd line 13:00 - 14:00 2 20



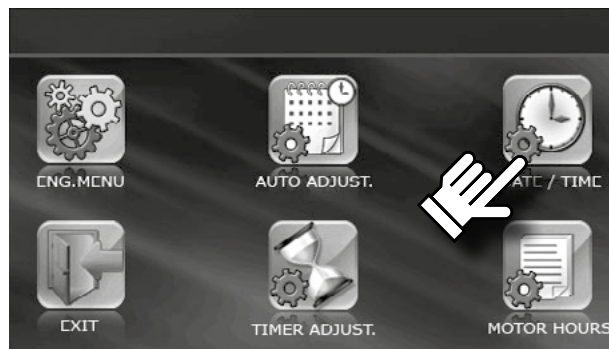

- The unit will operate in the **STANDBY** mode in the range between 12:00 and 13:00.

**20. Date and time**



- To set the date and time on the control panel, go to the User menu by pressing  (see para. 5) and then press **DATE, TIME** .



- Then adjust the year, month, date, hour and minutes by pressing  and .
- Press **ENTER**  to confirm the set parameter.
- To return to the Engineering menu without saving changes, press **EXIT** .

## 21. Timer

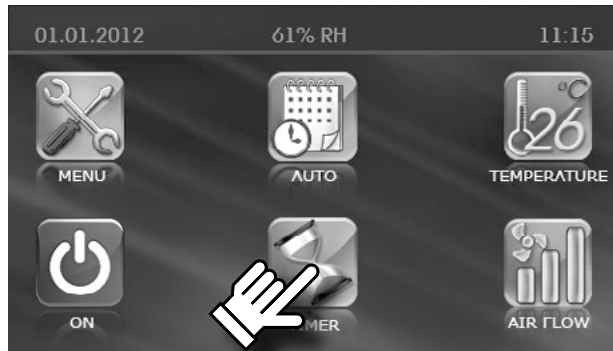

- To activate the timer, press **TIMER** in the control panel Main menu.

- To set up the **TIMER** mode, press to enter the User menu, see para. 5, and press **TIMER ADJUST** .

*The **TIMER** mode has a higher priority than the **AUTO** mode and manual control settings of air flow and temperature. When the timer is active, the unit switches to the timer-scheduled operation and ignores the schedule settings (**AUTO** mode) and manual control settings (**AIR FLOW** and **TEMPERATURE**).*

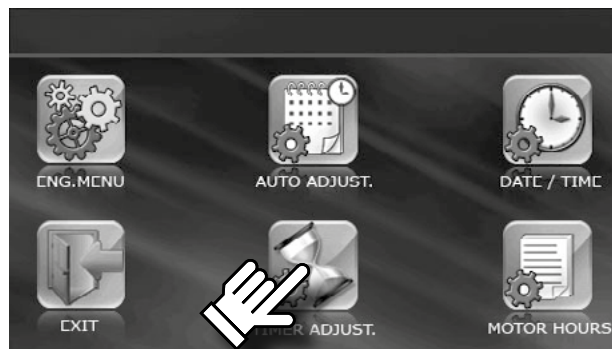

- Activation of the **TIMER** function is confirmed with a tick

*The timer cannot be activated once the **HUMIDITY CONTROL** mode is on.*

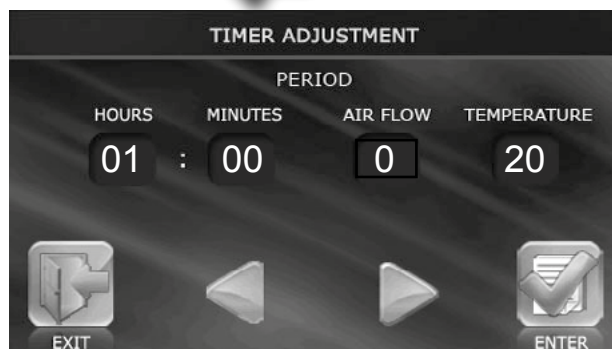

- Use or buttons to set the time, air flow and air temperature values.

- Press **ENTER** to confirm the set parameters.

- To return to the Engineering menu without saving changes, press



**EXIT** .

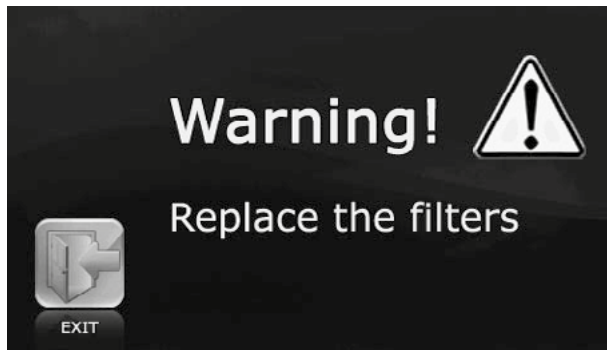
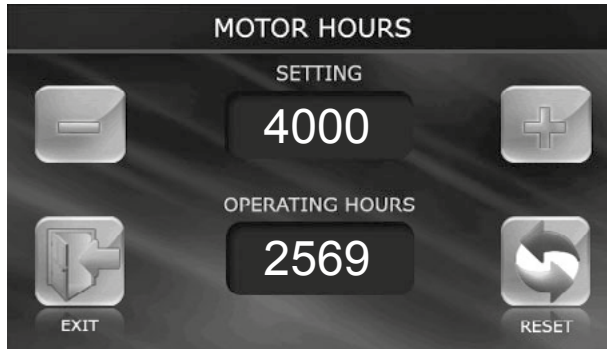
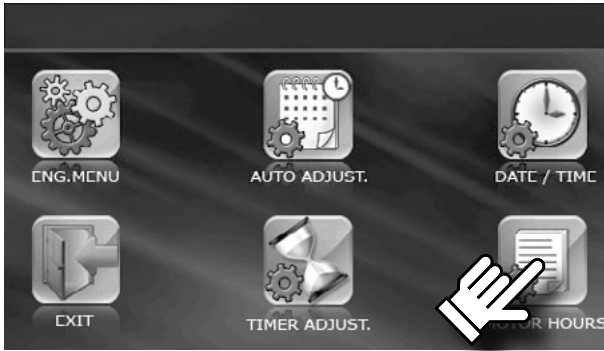

## 22. Motor hours



The **MOTOR HOURS** function enables the user to set up filter cleaning or replacement periodicity. Upon expiration of the preset time the panel displays a filter cleaning or replacement indicator. The indicator is displayed every 24 hours.

Press the **RESET** button to reset the motor hours.

- To set up the **MOTOR HOURS** function, enter the User menu by pressing the  button, see para. 5, and press **MOTOR HOURS** .

- Use the  or  buttons to set the filter replacement interval in the **MOTOR HOURS** window in the **SETTING** field.

- The **OPERATING HOURS** window shows the time elapsed from the filter installation.

- Press **RESET**  after replacement of the filter.

- To save the changes and return to the Engineering menu, press **EXIT** .

**CAUTION!** If the differential pressure sensors are used to monitor the contamination of the filters in the unit, set the filter replacement frequency to zero.

### 23. Errors

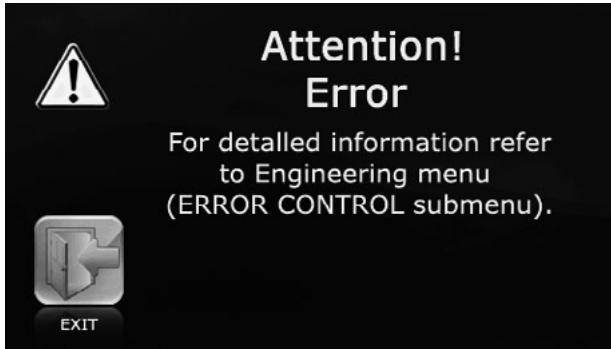

• The control panel displays the following message in case of any malfunctions in the ventilation unit operation.

- To enter the **ERROR LIST** press **EXIT** .
- The **ERROR LIST** can also be accessed from the Engineering menu.

*The error code details are stated in the table below.*

*The error message appears every 30 seconds until the system emergency cause has been troubleshooted.*

- To reset the error alert, restart the unit once the malfunction cause has been eliminated.

If the communication between the panel and the controller fails, a message **ERP** appears in the upper line of the main screen, which disappears when the connection is restored.

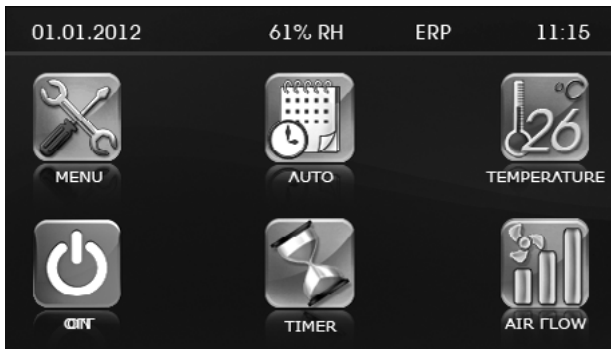

**ERROR CODE DESCRIPTION**

Error code	Heater type	
	ELECTRIC	WATER
TE1, TE2	Break of the sensor positive wire, short circuit of sensor output, malfunction or absence of the temperature sensor.	
TE3, TE4		Break of the sensor positive wire, short circuit of sensor output, malfunction or absence of the temperature sensor.
TE5	Break of the sensor positive wire, short circuit of sensor output, malfunction or absence of the temperature sensor.	
DI1	Triggering of the TK-60 thermal switch (the air temperature in the heating area exceeds +60 °C). Normally closed contact, self-resetting.	
DI2	Actuation of fire detector or short circuit in the sensor circuit. Normally opened contact.	
DI3	Triggering of the TK-90 thermal switch (the air temperature in the heating area exceeds +90 °C). Normally closed contact with manual reset. To reset, press the button on the sensor (for the units with electric heaters).	
DI5		No water pressure. Used for connection control of the NKP or NKD electric heaters to the unit. This alarm is reversible and the unit must not be restarted. When water pressure is detected, the unit restarts to operate. Install a jumper in case of no water pressure sensor in the units with a water heater.
TU1, TU2	Break of common power line of the sensor or malfunction of the temperature sensor.	
TU3, TU4		Break of common power line of the sensor or malfunction of the temperature sensor.
TU5	Break of common power line of the sensor or malfunction of the temperature sensor.	
TD5	Air temperature in the supply duct is below +5 °C. It is checked once in 17 minutes.	
FE1	Actuation of differential pressure sensor in the supply air duct. The air filter in the supply duct must be replaced. This alarm does not lead to shutdown of the ventilation unit, but acts as a warning sign.	
FE2	Actuation of differential pressure sensor in the extract air duct. The air filter in the extract duct must be replaced. This alarm does not lead to shutdown of the ventilation unit, but acts as a warning sign.	
ERP	Communication disturbance with the control panel. Break of wire A or B. Breakdown of interface or control panel.	

## FACTORY SETTINGS

PARAMETER		DEFAULT SETTINGS	MEASUREMENT UNIT
Air flow rate		1	-
Temperature	Duct	25	°C
	Room	20	
Air flow setting	Air supply	first speed 40 % second speed 70 % third speed 99 %	%
	Air extract	first speed 40 % second speed 70 % third speed 99 %	
Temperature sensor		Duct	-
Language selection		English	-
Extra options	Heating control	OFF	ON/OFF
	Supply fan off mode	OFF	ON/OFF
	Humidity sensor selection	2	-
	Bypass operation mode	1	-
Supply fan off mode	Working hours	20	Minute
	Downtime	5	Minute
	Switch-off temperature	-1	°C
Standby mode setting	Air flow rate	0	-
	Temperature	20	°C
Display brightness adjustment	Operation	50	-
	Sleep	1	-
Humidity setting	Duct	50	%
	Room	50	%
Temperature sensor correction		-4	°C
Timer settings	Hours	01	Hour
	Minutes	00	Minute
	Air flow rate	1	-
	Temperature	20	°C
Motor hours	Air handling unit	3000	Hour





Μιχαήλ Καρασολή 19, τκ 143 43, Ν. Χαλκηδόνα, Αθήνα  
Τηλ: 211 - 70.55.500 & 210 - 21.30.051, Fax: 210 - 22.23.283

