

HEAT RECOVERY AIR HANDLING UNITS

Series

VENTS VUT/VUE V2 mini EC



Air handling units with air flow up to **300 m³/h**.
Heat recovery efficiency up to **79 %**.

■ Description

The air handling units are the fully featured ventilation units with heat recovery for air filtration, fresh air supply and stale air extract. During operation the extract air heat is transferred to the supply air stream by the highly efficient plate heat exchanger. The units are designed for energy efficient ventilation of cottages and flats and are compatible with round air ducts (Ø 125 mm).

■ Casing

The casing of the VUT/VUE 300 V/H mini EC units is of aluzinc steel, internally filled with 20 mm mineral wool heat- and sound-insulating layer. The casing of the VUT/VUE 300 V/H mini EC units is made of white steel. The spigots for connection to the air ducts are located at the sides of the VUT/VUE 300 H2 mini EC unit and at the top of the VUT/VUE 300 V2 mini EC unit.

■ Fans

The units are equipped with high-efficient EC motors with an external rotor and forward curved blades. These state-of-the-art motors offer the very best in energy efficiency today. The high efficiency (up to 90 %) is a definite advantage of EC motors.

Series

VENTS VUT/VUE H2 mini EC



Air handling units with air flow up to **300 m³/h**.
Heat recovery efficiency up to **79 %**.

■ Heat exchanger

The **VUT H2/V2 mini EC** units are equipped with a cross-flow polystyrene heat exchanger. In the cold season the extract air heat is captured and transferred to the supply air stream which reduces the ventilation-generated heat losses. This can lead to formation of condensate that is collected in a special drain pan and discharged into the sewage system. In the warm season the ambient air heat is transferred to the exhaust air stream. This allows for a considerable reduction of the supply air temperature which, in turn, reduces the air conditioning load.

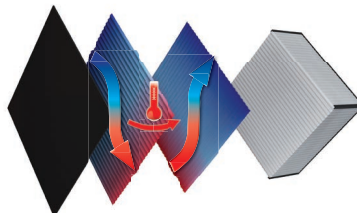

The **VUE H2/V2 mini EC** units are equipped with a cross-flow heat exchanger made of polymerized cellulose. In the cold season the extract air heat and moisture are transferred to the supply air stream through the enthalpy membrane reducing the heat losses from ventilation.

Consequently, it is the ambient air heat and moisture transferred to the exhaust air stream through the enthalpy membrane in the warm season.

This allows for a considerable reduction of the supply air temperature and humidity which, in turn, reduces the air conditioning load.

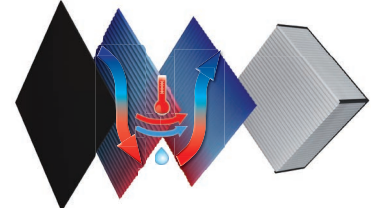

■ Filter

Two built-in filters with filtration class G4 and F8 provide efficient supply air filtration. Extract air is cleaned by a built-in filter with filtration class G4.

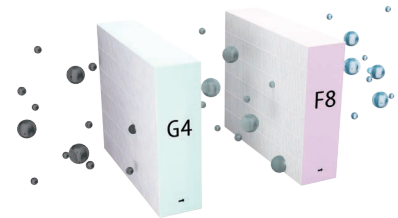

■ Control and automation

The VUT/VUE 300 H2 mini EC A2 / VUT/VUE 300 V2 mini EC A2 unit is equipped with an A2 speed controller (R-1/010).



The unit is controlled by the control signal 0-10V. The VUT/VUE 300 H2 mini EC A14 / VUT/VUE 300 V2 mini EC A14 unit is equipped with a remote control panel with touch buttons and LED indication.

The heat exchanger freeze protection operates as follows: in case of freezing danger determined by the temperature sensor the supply fan is turned off to let extract air warm up the heat exchanger. After freezing danger is no longer imminent, the unit reverts to the standard operation mode.



Designation key

Series	Rated air flow [m ³ /h]	Mounting type	Casing type	Model	Motor type	Casing colour	Control type
VUT: ventilation with heat recovery VUE: ventilation with energy recovery	300	H: horizontal installation V: vertical installation	2: 20 mm insulation	mini	EC: synchronous electronically commutated motor	_: aluzinc White: white painted	A2: speed controller A14: sensor control panel with LED indication

Installation

Mounting to floor or wall with fixing brackets. The VUE 300 H2 mini EC can also be suspended to the ceiling. The VUT 300 H2 mini EC unit installation position must provide proper condensate drainage.

While mounting provide free access to the service panel for filter replacement and servicing. Universal casing design provides either left-handed or right-handed unit installation. It requires reversing of the front and the back panels.

Overall dimensions

Model	Dimensions [mm]					
	Ø D	B	H	H1	L	L1
VUT 300 V2 mini EC	125	300	443	490	713	-
VUT 300 H2 mini EC	125	300	443	486	713	810

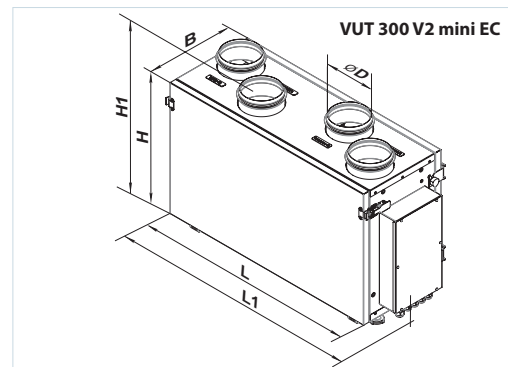
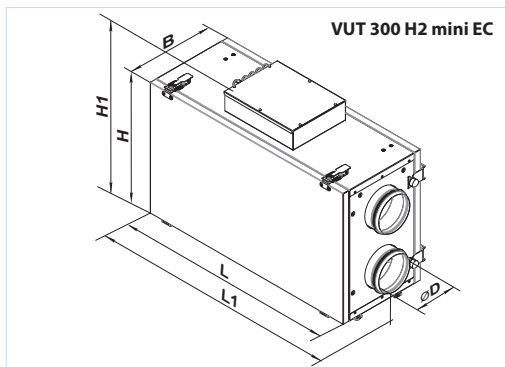

Technical data





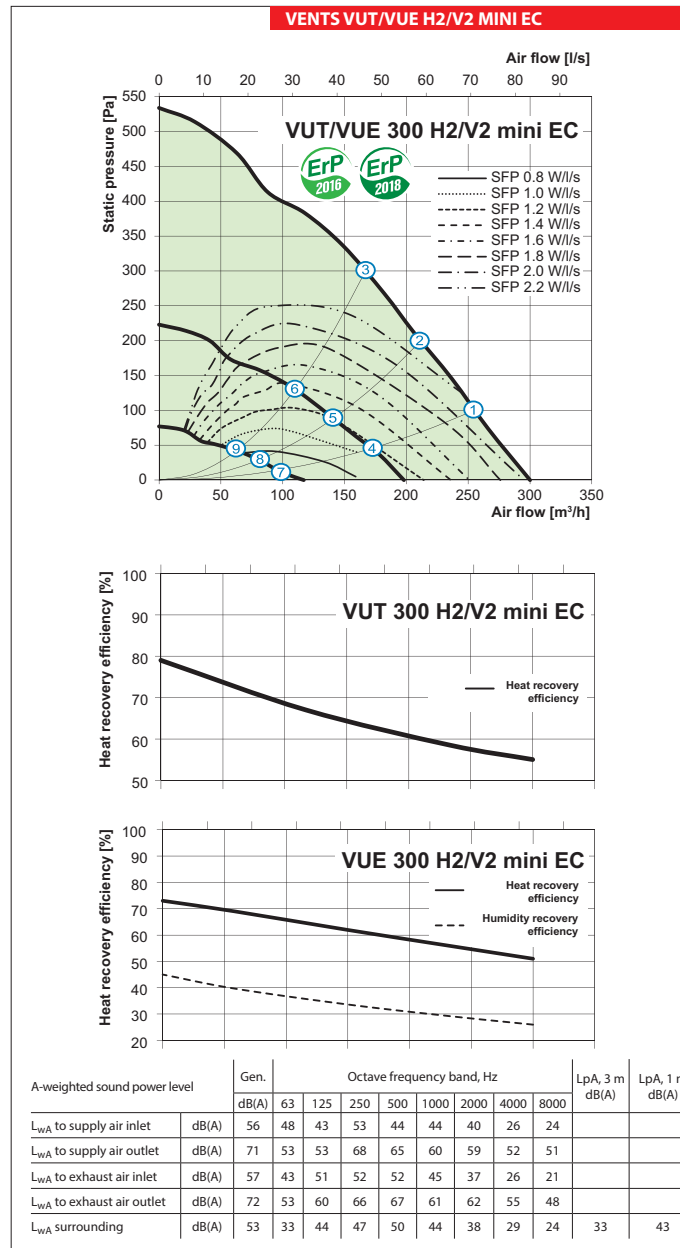

	VUT 300 H2 mini EC VUT 300 V2 mini EC	VUE 300 H2 mini EC VUE 300 V2 mini EC
Voltage [V / Hz]	1 ~ 230	
Maximum unit power (without a heater) [W]	165	
Maximum unit current (without a heater) [A]	1,3	
Max. air flow [m³/h]	300	
RPM [min ⁻¹]	2050	
Sound pressure level at a distance of 3 m [dB(A)]	33	
Transported air temperature [°C]	from -25 up to +60	
Insulation	20 mm mineral wool	
Filter: extract filter	G4	
Filter: supply filter	G4, F8	
Connected air duct diameter [mm]	Ø125	
Weight [kg]	32	28
Heat recovery efficiency [%]	from 55 up to 79	from 51 up to 73
Humidity recovery efficiency [%]	-	from 26 up to 45
Heat exchanger type	cross-flow	
Heat exchanger material	polystyrene	polymerized cellulose
SEC class (A2)	B	C
SEC class (A14)	A	A

VENTS
 AIR HANDLING UNIT WITH
 VUT / VUE H2/
 V2-MINI EC
 HEAT RECOVERY SERIES

HEAT RECOVERY AIR HANDLING UNITS

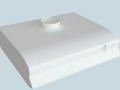

Accessories

Model	Panel filter G4	Panel filter F8	Indoor humidity sensor (0-10 V)	Outdoor CO ₂ sensor with indication	Outdoor CO ₂ sensor	Outdoor humidity sensor	Kitchen hood	
								
VUT 300 H2/V2 mini EC A2	SF 240x184x40 G4	SF 240x184x40 F8	-	-	-	-	-	
VUE 300 H2/V2 mini EC A2								
VUT 300 H2/V2 mini EC A14								
VUE 300 H2/V2 mini EC A14					HV-2	CO2-1	CO2-2	HR-S

Model	Silencers		Back valves	Air dampers	Clamps	Hydraulic U-trap	Electric actuator
							
VUT 300 H2/V2 mini EC A2	SR 125	SRF 125	KOM 125	KRV 125	S 125	SH-32	-
VUE 300 H2/V2 mini EC A2							
VUT 300 H2/V2 mini EC A14							
VUE 300 H2/V2 mini EC A14							LF230

Application options

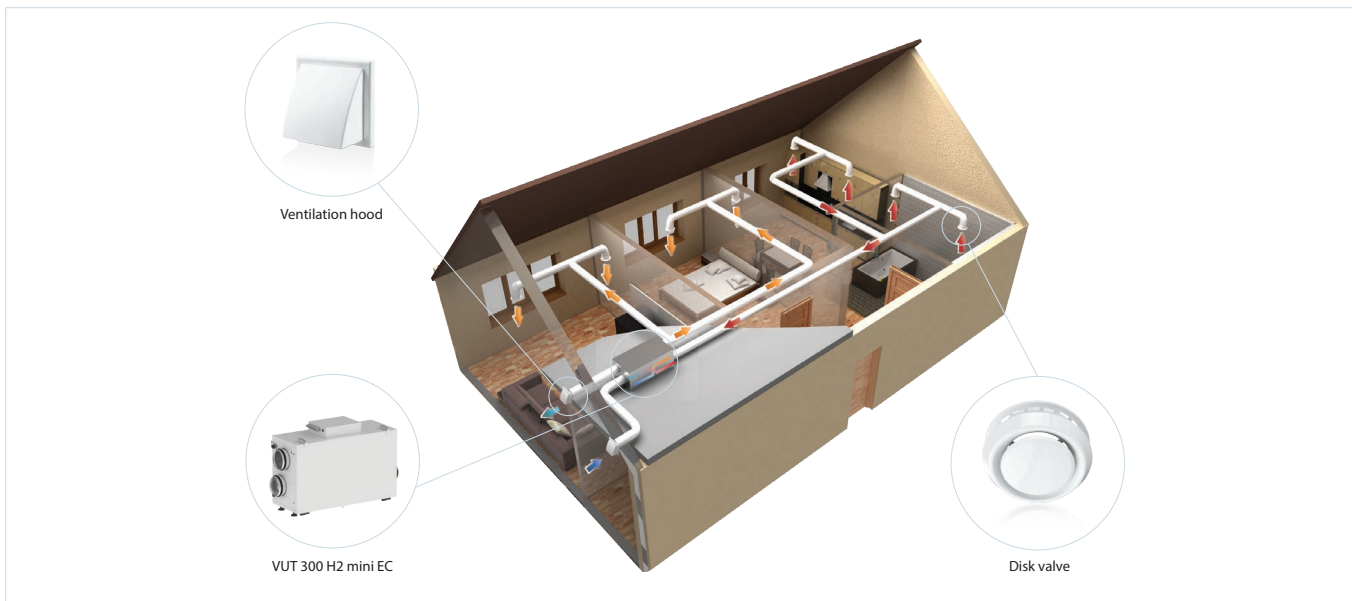

VENTS
AIR HANDLING UNIT WITH
VUT / VUE H2/
HEAT RECOVERY SERIES
V2 MINI EC