

# HC

## Wall-mounted axial fans with IP55 motors



HC



HC 71, 80, 90, 100

Wall-mounted axial fans with reinforced plastic impeller made of fibreglass.

### Fan:

- Sheet steel support frame.
- Fibreglass-reinforced polyamide-6 impeller.
- Anti-contact protective grille pursuant to standard UNE-EN ISO 12499.
- Models 71, 80, 90 and 100, protective grille supplied as an accessory
- Airflow direction from motor to impeller.

### Motor:

- IE3 efficiency motors for powers equal to or higher than 0.75kW except single-phase, 2-speed and 8-pole.
- Class F motors with ball bearings, IP55 protection, except single-phase models from size 45 to size 63, IP54 protection. 1 or 2 speeds, depending on model

- Single-phase 230V-50Hz and three-phase 230/400V-50Hz (up to 4kW) and 400/690V 50Hz (powers higher than 4kW)
- Operating temperature: -25 °C +60 °C.

### Finish:

- Anti-corrosive finish of polyester resin polymerised at 190°C, previously degreased with phosphate-free nanotechnological treatment.

### On request:

- Motor, impeller and grille assembly (F version), except models 71, 80, 90 and 100, which are supplied without a grille.
- Motor impeller unit, version G.
- Airflow direction from impeller to motor.
- Special windings for different voltages.

### Order code

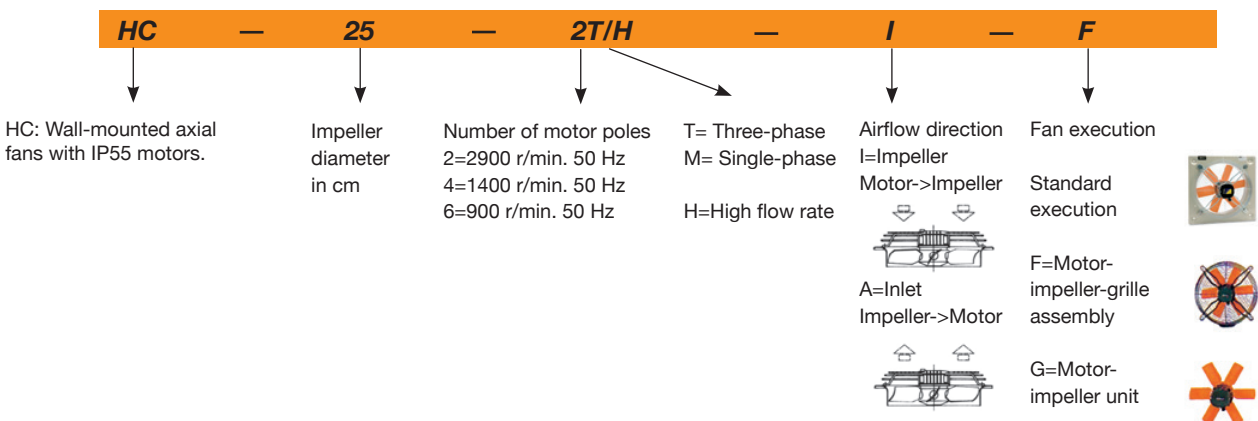

### Technical characteristics

Model	Speed (r/min)	Maximum admissible current (A)			Installed power (kW)	Maximum flow rate (m³/h)	Sound pressure level dB(A)	Approx. weight (kg)	According to ErP
		230V	400V	690V					
HC-25-2T/H	2730	0.70	0.40	0.12	2200	64	5	2015	
HC-25-2M/H	2730	1.10		0.12	2200	64	5	*	
HC-25-4T/H	1350	1.10	0.60	0.09	1300	51	5	Excluded	
HC-25-4M/H	1350	1.10		0.09	1300	51	5	Excluded	
HC-31-2T/H	2750	1.21	0.70	0.18	3650	72	6	2015	

## Technical characteristics

Model	Speed (r/min)	Maximum admissible current (A)			Installed power (kW)	Maximum flow rate (m <sup>3</sup> /h)	Sound pressure level dB(A)	Approx. weight (kg)	According to ErP
		230V	400V	690V					
HC-31-2M/H	2700	1.85			0.18	3600	72	6	2015
HC-31-4T/H	1350	1.10	0.60		0.09	2400	54	6	Excluded
HC-31-4M/H	1430	0.99			0.10	2400	54	6	Excluded
HC-35-2T/H	2710	1.92	1.11		0.37	6050	76	8	2015
HC-35-4T/H	1350	1.10	0.60		0.09	3550	58	7	2015
HC-35-4M/H	1440	1.08			0.10	3550	58	7	2015
HC-40-4T/H	1350	1.66	0.96		0.25	5200	63	10	2015
HC-40-4M/H	1370	2.00			0.25	5200	63	10	2015
HC-40-6T/H	900	1.51	0.87		0.25	3700	55	10	2015
HC-40-6M/H	970	1.30			0.25	3700	55	10	*
HC-45-4T/H	1370	2.02	1.17		0.37	7300	66	14	2015
HC-45-4M/H	1400	2.76			0.37	7300	66	14	2015
HC-45-6T/H	900	1.51	0.87		0.25	5150	57	14	2015
HC-45-6M/H	950	1.50			0.25	5150	57	14	2015
HC-50-4T/H	1380	2.92	1.69		0.55	10200	69	18	2015
HC-50-4M/H	1350	5.02			0.55	10200	69	18	2015
HC-50-6T/H	900	2.24	1.30		0.37	6300	59	18	2015
HC-50-6M/H	900	2.69			0.37	6300	59	18	*
HC-56-4T/H IE3	1455	4.07	2.34		1.10	13000	72	28	2015
HC-56-6T/H	900	2.24	1.30		0.37	8300	61	19	2015
HC-56-6M/H	900	2.69			0.37	8300	61	19	2015
HC-63-4T/H IE3	1455	4.07	2.34		1.10	16450	74	30	2015
HC-63-6T/H	900	2.24	1.30		0.37	12350	64	21	2015
HC-63-6M/H	890	3.00			0.37	12350	64	21	2015
HC-71-4T/H IE3	1440	5.41	3.11		1.50	22150	78	43	2015
HC-71-6T/H IE3	940	3.36	1.93		0.75	17300	66	39	2015
HC-71-6M/H	900	4.97			0.75	15600	65	36	2015
HC-80-4T/H IE3	1440	10.70	6.15		3.00	33000	82	60	2015
HC-80-6T/H IE3	940	3.36	1.93		0.75	22000	71	48	2015
HC-90-4T/H IE3	1450	13.90	8.00		4.00	43700	86	70	2015
HC-90-6T/H IE3	950	6.43	3.70		1.50	33300	76	64	2015
HC-100-4T/H IE3	1465		10.30	5.97	5.50	54000	88	108	2015
HC-100-6T/H IE3	950	6.43	3.70		1.50	37000	78	67	2015

\* Equipment not covered by Directive 2009/125/EC



## Erp. (Energy Related Products)

Information on Directive 2009/125/EC can be downloaded from the SODECA website or the QuickFan selector programme.

## Acoustic characteristics

The indicated values are determined by measuring the pressure and sound power levels in dB(A) obtained in a free field at a distance equivalent to twice the size of the fan plus the impeller diameter, with a minimum of 1.5 m.

Noise power spectrum Lw(A) in dB(A) frequency band in [Hz]

Model	63	125	250	500	1000	2000	4000	8000	Model	63	125	250	500	1000	2000	4000	8000
25-2T/H	38	48	65	65	73	69	62	53	56-6T/H	28	45	58	65	70	71	66	59
25-4T/H	25	35	52	52	60	56	49	40	63-4T/H	43	60	73	80	85	86	81	74
31-2T/H	46	56	73	73	81	77	70	61	63-6T/H	33	50	63	70	75	76	71	64
31-4T/H	28	38	55	55	63	59	52	43	71-4T/H	47	64	77	84	89	90	85	78
35-2T/H	50	60	77	77	85	81	74	65	71-6T/H	35	52	65	72	77	78	73	66
35-4T/H	32	42	59	59	67	63	56	47	80-4T/H	60	81	88	93	96	92	85	74
40-4T/H	28	45	57	65	70	70	66	59	80-6T/H	49	70	77	82	85	81	74	63
40-6T/H	20	37	49	57	62	62	58	51	90-4T/H	64	85	92	97	100	96	89	78
45-4T/H	33	50	63	70	75	76	71	64	90-6T/H	54	75	82	87	90	86	79	68
45-6T/H	24	41	54	61	66	67	62	55	100-4T/H	68	88	96	101	103	100	93	82
50-4T/H	36	53	66	73	78	79	74	67	100-6T/H	58	78	86	91	93	90	83	72
50-6T/H	26	43	56	63	68	69	64	57									
56-4T/H	39	56	69	76	81	82	77	70									

**Dimensions mm**
**HC-25...63**

Model	A	B	ØC	ØD	E	G	H	ØJ	K
HC-25	330	275	262	260	241	11	56	8.5	310
HC-31-2	400	336	310.5	308	264.5	11	65	8.5	380
HC-31-4	400	336	310.5	308	245.5	11	65	8.5	380
HC-35-2	465	390	362.5	360	310	11	76	10.5	450
HC-35-4	465	390	362.5	360	261	11	76	10.5	450
HC-40-4.../H	532	452	412.5	410	332	11	97.5	10.5	500
HC-40-6.../H	532	452	412.5	410	332	11	97.5	10.5	500
HC-45-4.../H	596	504	462.5	460	339	11	105	10.5	560
HC-45-6.../H	596	504	462.5	460	339	11	105	10.5	560
HC-50-4T/H	665	562	516.5	514	376	11	115	10.5	640
HC-50-4M/H	665	562	516.5	514	376	11	115	10.5	640
HC-50-6.../H	665	562	516.5	514	336	11	115	10.5	640
HC-56-4T/H	710	630	563	560	374	15	115	10.5	721
HC-56-6.../H	710	630	563	560	351	15	115	10.5	721
HC-63-4T/H	800	710	638	635	399	15	140	10.5	820
HC-63-6.../H	800	710	638	635	376	15	140	10.5	820

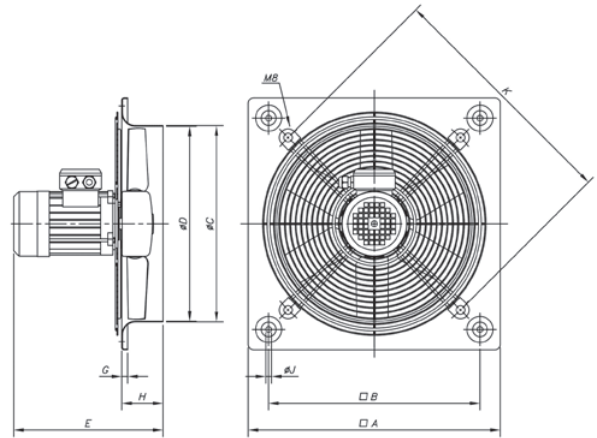
**HC-71...100**

Model	A	B	ØC	ØD	E	G	H	ØJ
HC-71-4T/H	850	810	714	710	395	20	150	14.5
HC-71-6T/H	850	810	714	710	395	20	150	14.5
HC-80-4T/H	970	910	804	800	500	20	180	14.5
HC-80-6T/H	970	910	804	800	458	20	180	14.5
HC-90-4T/H	1170	1110	904	900	511	20	180	14.5
HC-90-6T/H	1170	1110	904	900	500	20	180	14.5
HC-100-4T/H	1170	1110	1004	1000	548	20	180	14.5
HC-100-6T/H	1170	1110	1004	1000	498	20	180	14.5

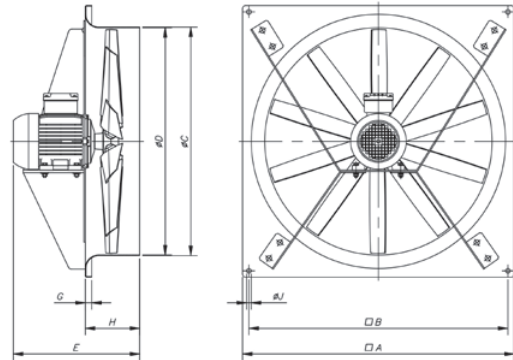
**Characteristic curves**

 Q= Flow rate in m<sup>3</sup>/h, m<sup>3</sup>/s and cfm.

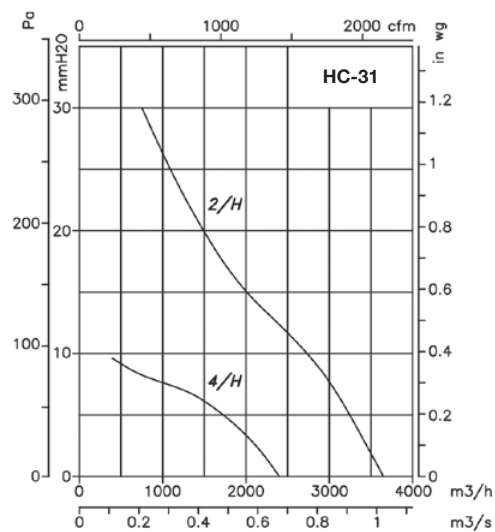
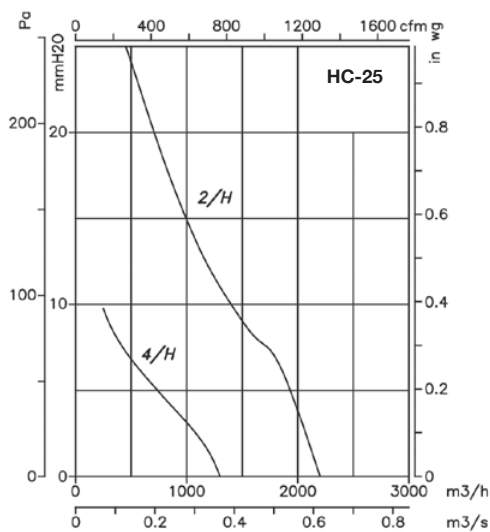
 Pe= Static pressure in mm H<sub>2</sub>O, Pa and inwg.

**Characteristic curves**

Q= Flow rate in m<sup>3</sup>/h, m<sup>3</sup>/s and cfm.

Pe= Static pressure in mm H<sub>2</sub>O, Pa and inwg.

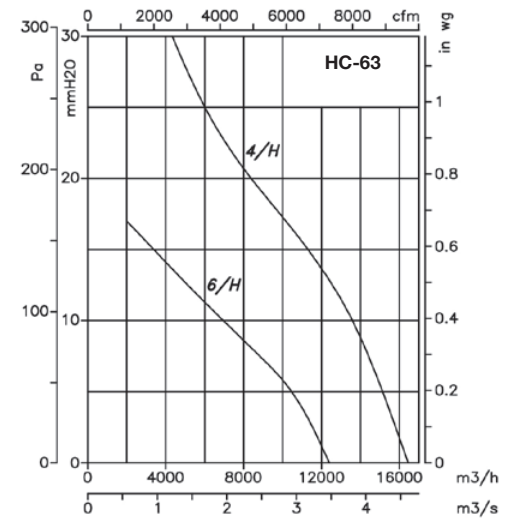
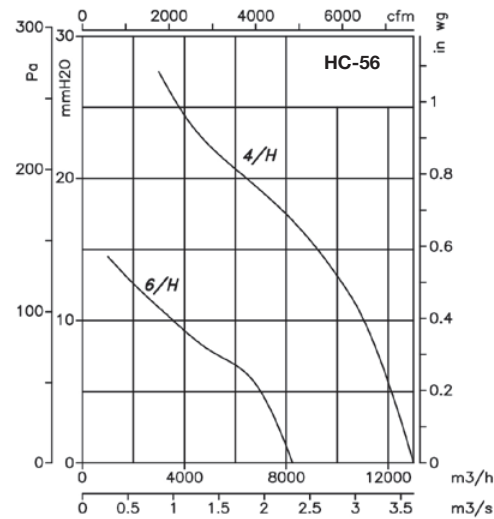
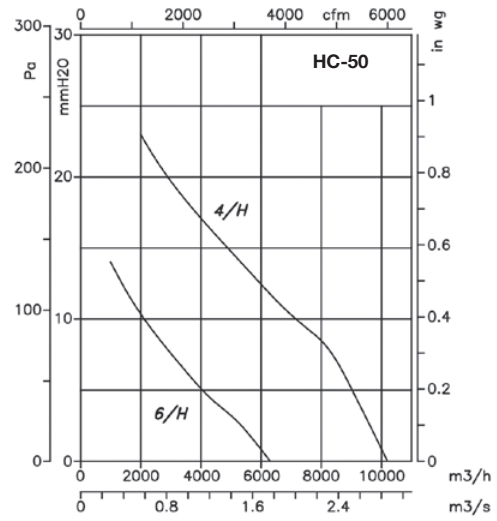
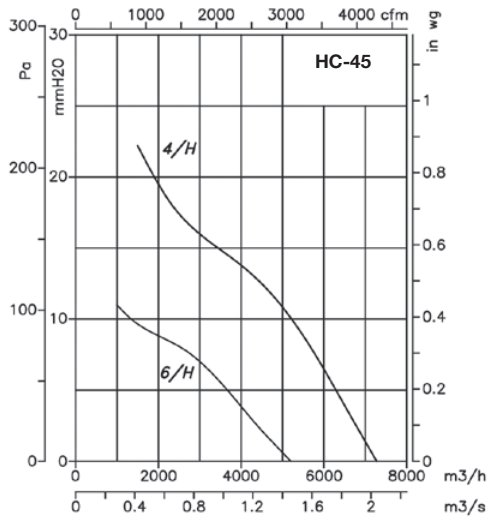
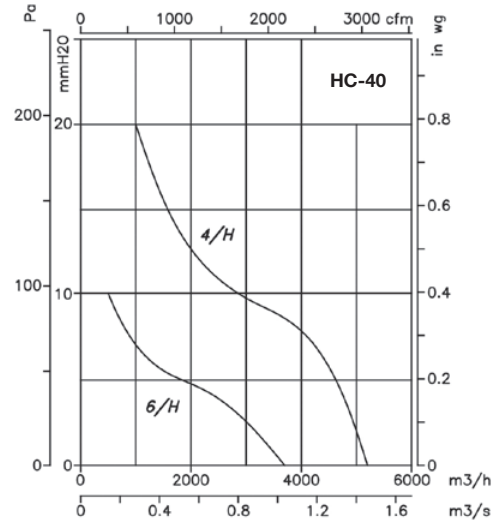
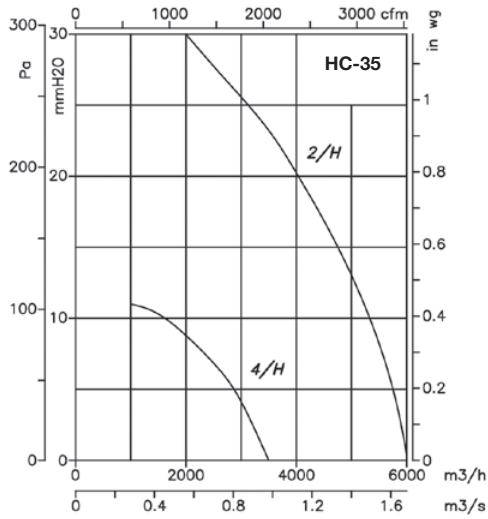

## AXIAL FANS AND ROOF-MOUNTED EXTRACT FANS

### Characteristic curves

Q= Flow rate in m<sup>3</sup>/h, m<sup>3</sup>/s and cfm.

Pe= Static pressure in mm H<sub>2</sub>O, Pa and inwg.

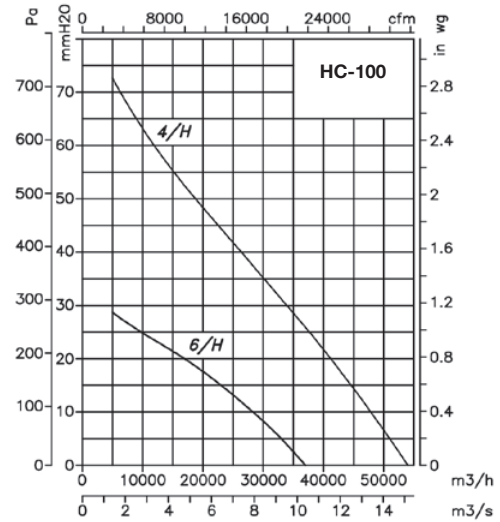
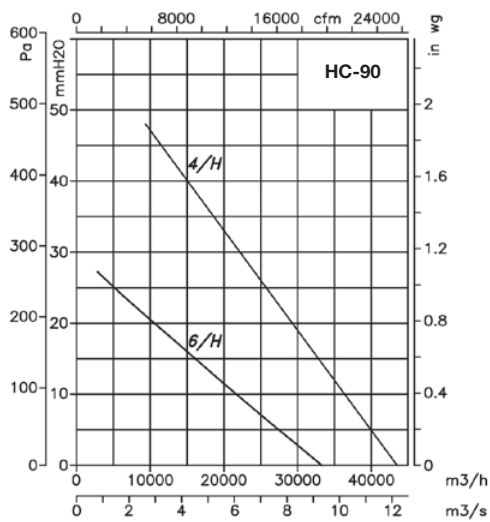
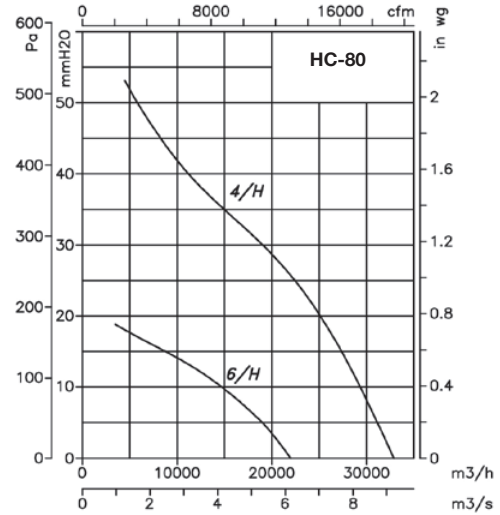
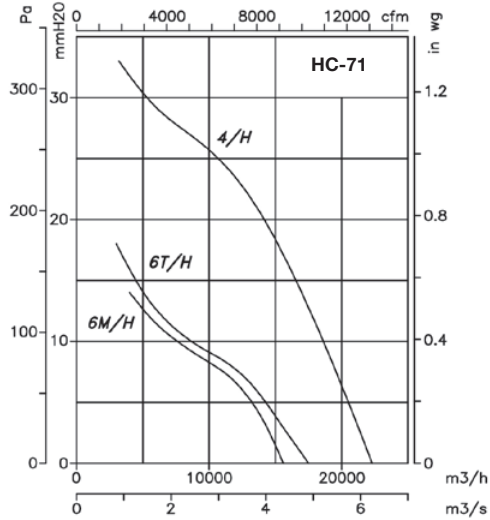

### Accessories

See accessories section.

