

SINGLE-ROOM ENERGY RECOVERY UNITS

EASY-D RL7-50-17



Power from
2.37 W 

Air flow up to
50 m³/h 

Sound pressure level from
12 dBA 

EFFICIENT, RELIABLE AND ENERGY-SAVING VENTILATORS 24 HOURS A DAY:



Supply clean fresh air to the premises



Low energy demand



Remove stale extract air from the premise



Recover heat and provide humidity balance inside

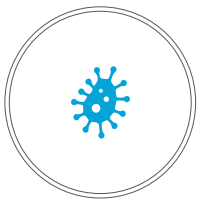

Prevent penetration of excessive humidity and appearance of mould



Reduce the heating costs in winter and air conditioning costs in summer



Protect against outdoor noise



Clean the air of dust and insects



APPLICATION

The ventilators are designed to ensure continuous mechanical air exchange in flats, cottages, hotels, cafés and other domestic and public premises. The ventilators are equipped with a regenerator that enables supply of fresh filtered air heated by means of extract air heat regeneration. The ventilators are designed for through-the-wall mounting and are rated for continuous operation. Transported air must not contain any flammable or explosive mixtures, evaporation of chemicals, sticky substances, fibrous materials, coarse dust, soot and oil particles or environments favourable for the formation of hazardous substances (toxic substances, dust, pathogenic germs).

VENTILATOR DESIGN

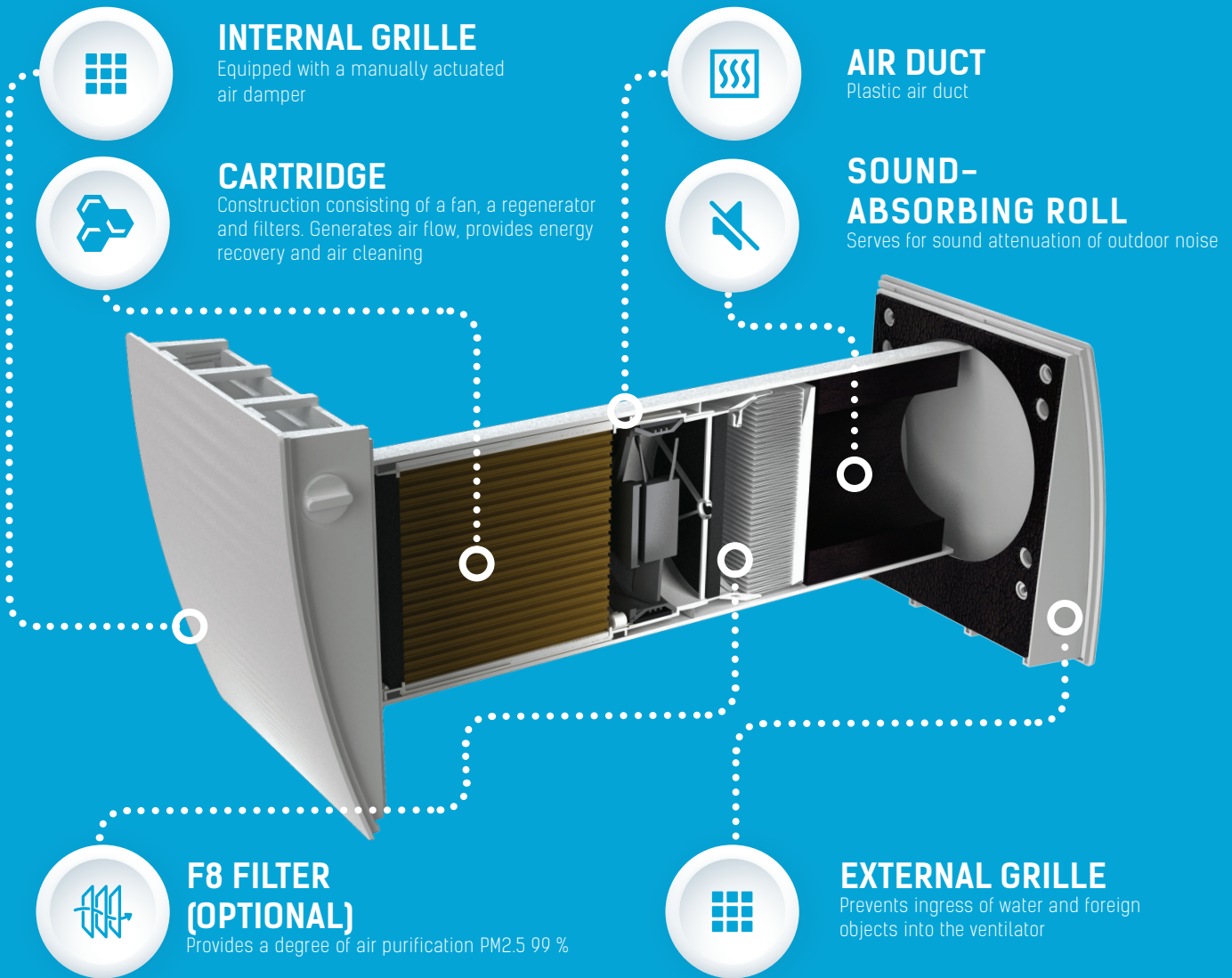

● CERAMIC HEAT EXCHANGER

The high-technology ceramic energy heat exchanger is used for extract air heat regeneration and supply air heating. Due to its cellular structure, the unique energy accumulator has larger air contact area and excellent heat conducting and accumulating properties. The ceramic energy accumulator has a special anti-bacterial treatment to prevent bacteria generation inside of the regenerator. The antibacterial treatment is rated for 10 years operation.

● AIR FILTERS

Two built-in filters with total filter class G3 are used to clean supply and extract air flows. The filters ensure fresh air cleaning of dust and insects

and prevent the ventilator parts from soiling. The filters have antibacterial treatment. The filters are cleaned either with a vacuum cleaner or flushed with water with no harm to the antibacterial treatment. Optionally, an F8 filter is available. When installed, it reduces the performance of the ventilator to 40 m³/h.

● REVERSIBLE DC FAN

Air is supplied or extracted by a reversible axial fan with a DC motor with safe voltage 12 V. Due to DC technology the fan is distinguished with low energy demand. The motor has overheating protection and ball bearings for longer service life.

CONTROL AND OPERATION MODES

The ventilator is operated with a wall-mounted control panel or a remote control for your convenience.



OPERATION MODES:

- **Ventilation mode.** In this mode one ventilator constantly supplies air and the other one extracts it.
- **Regeneration mode.** The ventilators operate in opposite phases and in two cycles, 70 seconds each, to provide heat and moisture regeneration.

UNIT OPERATION LOGIC

Energy is recovered due to reversing operation of the ventilator, which consists of two cycles:

● CYCLE I

Warm stale air is extracted from the room, then it passes through the ceramic energy accumulator and while flowing through it, heats and moistens the ceramic accumulator. In 70 seconds after the regenerator gets warmed the ventilator is automatically switched to supply mode.

● CYCLE II

Clean fresh air from outside passes through the ceramic energy accumulator, absorbs moisture and is heated up to the room temperature due to the accumulated heat. In 70 seconds after the regenerator gets cooled down, the fan is switched to air extract mode and the cycle is renewed. The changeover between the supply and extract modes takes place each 70 seconds.

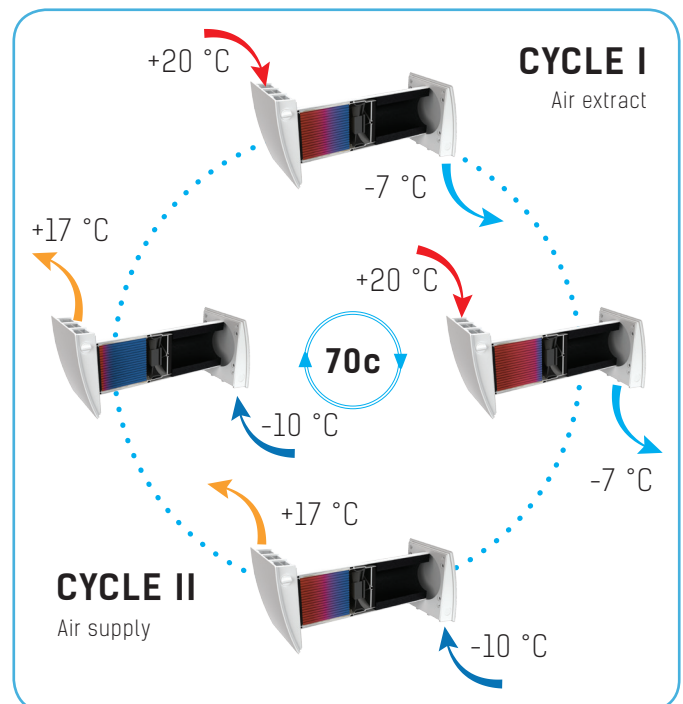

TECHNICAL DATA

Specific energy consumption (SEC) [kWh/(m ² a)]	Cold climate		Moderate climate		Warm climate	
	-76.2	A+	-37.0	A	-15.0	E
Type of ventilation unit	Bidirectional					
Type of drive installed	Three-speed					
Type of heat recovery system	Regenerative					
Thermal efficiency of heat recovery [%]	76					
Maximum flow rate [m ³ /h]	50					
Power [W]	7.6					
Sound power level [dBA]	38					
Reference flow rate [m ³ /s]	0.008					
Reference pressure difference [Pa]	0					
Specific power input (SPI) [W/m ³ /h]	0.127					
Control system type	Clock control					
Maximum internal leakage rates [%]	2.7					
Maximum external leakage rates [%]	0					
Mixing rate of bidirectional units [%]	1					
Airflow sensitivity at +20 Pa and -20 Pa	0.40					
The indoor/outdoor air tightness [m ³ /h]	0.5					
Internet address	http://www.ventilation-system.com/					
The annual electricity consumption (AEC) [kWh electricity/a]	Cold climate		Moderate climate		Warm climate	
	162		162		162	
The annual heating saved (AHS) [kWh primary energy/a]	Cold climate		Moderate climate		Warm climate	
	8024		4101		1855	

Speed	1	2	3
Voltage [V/Hz]	100-240 / 50-60		
Power [W]	2.37	3.80	7.61
Total unit current [A]	0.033	0.047	0.080
Air flow [m ³ /h]	15	30	50
Air flow in regeneration mode [m ³ /h]	15	30	50
Specific power input [W/l/s]	0.57	0.46	0.55
RPM [min ⁻¹]	915	1555	2330
Sound pressure level at 1 m distance [dBA]	21	27	29
Sound pressure level at 3 m distance [dBA]	12	18	20
Outdoor noise attenuation [dBA]	41		
Heat recovery efficiency [%]	≤ 92		
Transported air temperature [°C]	-15°...+40		
Filter	G3 (F8 optional)		
F8 filter filtration rate PM2.5 [%]	99		
Air flow with F8 filter applied [m ³ /h]	40		

* -30 °C (-22 °F) if S3 TwinFresh cartridge and EH-13 hood are applied

ENERG
енергия · енеруєтє
IE IA

VENTS EASY-D RL7-50-1'

A+

A

B

C

D

E

F

G

A

38 dBA

50 m³/h

ENERGIA · ЕНЕРГИЈА · ЕΝΕΡΓΕΙΑ · ENERGIJA · ENERGY · ENERGIE · ENERGI
2018 1254/2014

OVERALL DIMENSIONS

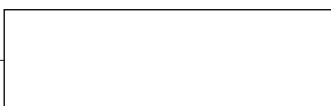
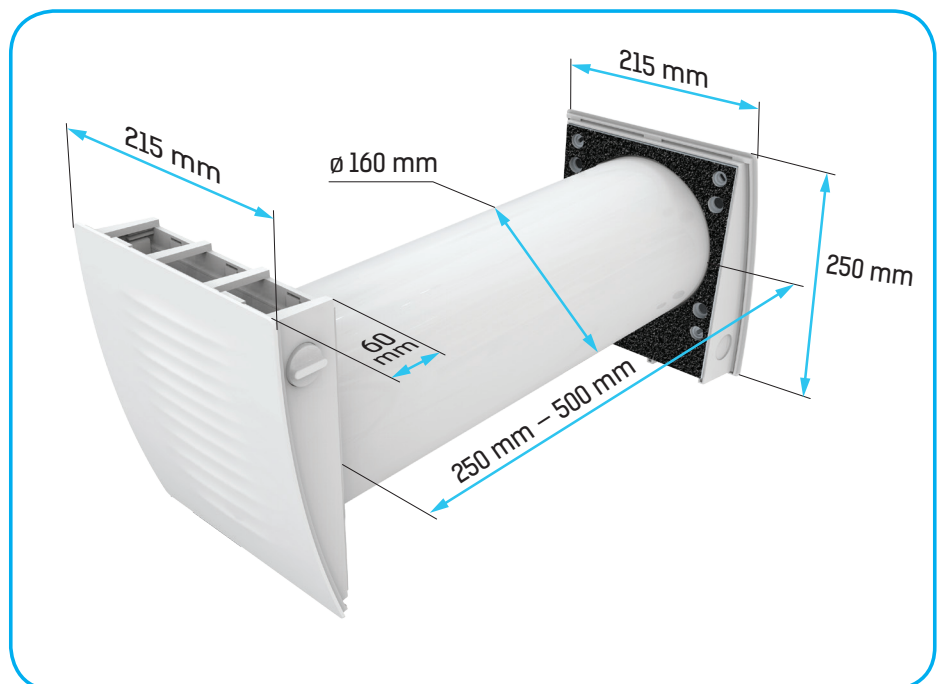

VENTILATION ARRANGEMENT EXAMPLE

To arrange a ventilation system based on TwinFresh ventilators, install one ventilator in each room. For larger premises, install two or more ventilators. It is advisable to use paired units to ensure balanced ventilation. While integrating many ventilators into a single network one part of them must be set into air supply mode and the other part must be set into air extract mode. TwinFresh may be used as an individual unit. In this case the ventilation mode must be selected individually for each room.

Air flows from one room to another through door grilles, openings or halls and provides that way required circulation in a premise. An energy regeneration ventilation system based on the TwinFresh ventilators is designed to save operating costs for heating and air conditioning. VENTS iFan WiFi fans are recommended for the most energy-efficient extract ventilation in kitchens and bathrooms. Polluted air is extracted automatically in case of actuation of the motion or humidity sensors.



INSTALLATION EXAMPLE



Mounting into a wall with a standard thickness using the EH-14 outer grille



Flush mounting using the NP angular mounting kit



Mounting into a thin wall using the EH-2 outer hood

ACCESSORIES

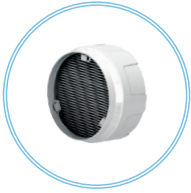

SF TwinFresh Easy R-50 F8
F8 Filter (complete with a plastic cup)

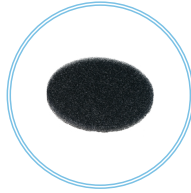

SF TwinFresh Easy R-50 G3
G3 filter set (2 pcs.)



MVM0 150 bV1s An
Round metal grille



MVM 152 bVsN
Round stainless steel outer hood



MVVM 162 05
Outer hood for mounting from indoor

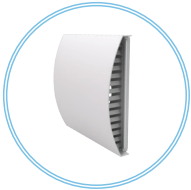

EH-14 white 160
White plastic outer hood

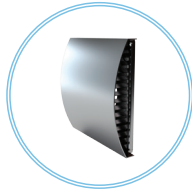

EH-14 chrome 160
Grey plastic outer hood with a brushed stainless steel cover

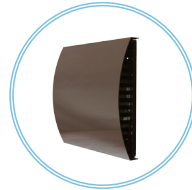

EH-14 brown 160
Brown plastic outer hood

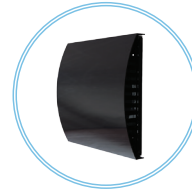

EH-14 black 160
Black plastic outer hood

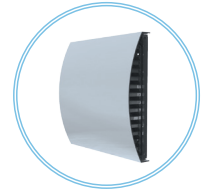

EH-14 grey 160
Grey plastic outer hood

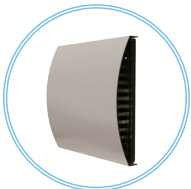

EH-14 beige 160
Beige plastic outer hood

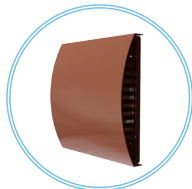

EH-14 terracotta 160
Terracotta plastic outer hood



EH-17 white 160
White plastic outer hood

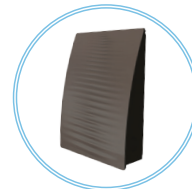

EH-17 brown 160
Brown plastic outer hood

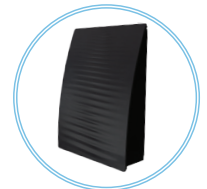

EH-17 black 160
Black plastic outer hood

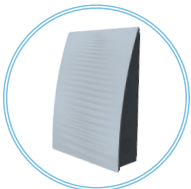

EH-17 grey 160
Grey plastic outer hood

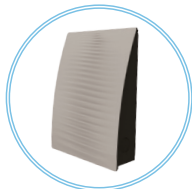

EH-17 beige 160
Beige plastic outer hood

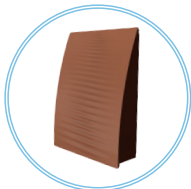

EH-17 terracotta 160
Terracotta plastic outer hood

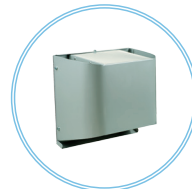

EH-2 grey 160
Grey painted stainless steel outer hood for thin walls



EH-2 chrome 160
Brushed stainless steel outer hood for thin walls

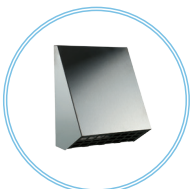

EH-13 chrome 160
Brushed stainless steel outer hood for cold climate

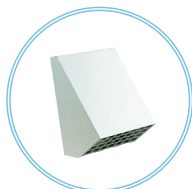

EH-13 white 160
White painted aluminium outer hood for cold climate

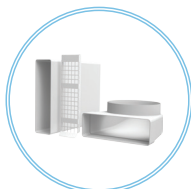

NP white 160
Angular mounting kit



NP chrome 160
Angular mounting kit

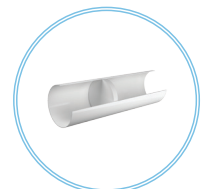

Duct 160-500
Air duct 500 mm

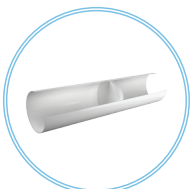

Duct 160-700
Air duct 700 mm



RK TwinFresh Easy RL-50
Remote control



KV TwinFresh Easy RL-50
LCD control panel



S3 TwinFresh
Cartridge for cold climate



Μιχαήλ Καραολή 19, τκ 143 43, Ν. Χαλκηδόνα, Αθήνα
Τηλ: 211 - 70.55.500 & 210 - 21.30.051, Fax: 210 - 22.23.283



The catalogue information is for reference only.

VENTS reserves the rights to modify any of its products' features, designs, components and specifications at any time and without notice to maintain the development and quality of manufactured goods.