



BRF-V

VERTICAL OUTLET ROOF FANS

Fan Components and Material Properties

The BRF-V series of vertical-centric roof-type radial fans are made of galvanized sheet steel with the body, mounting plate and fan wheels of the models BRF-V 225-400. The fan wheels of the BRF 450-500-560 models are made of aluminum sheet. All models have an external rotor motor with closed structure. The device is capable of handling air at max.40°C.

Fan Structure

The fan blades are aerodynamically curved and provide regular flow. The fans are composed of backward sloping and infrequently arranged fins.

Benefits

BRF-V roof fans are particularly advantageous in vertical applications due to the fact that air cannot be absorbed horizontally. Thanks to the aerodynamic wing structure, they work quietly. Speed can be adjusted with speed control devices.

Since the rainwater is easily evacuated, water ingress is prevented from entering the chimney.

Speed Control

Optional control devices can be provided. Speed control can be done with linear voltage regulator in 1~phase products (see BSC accessory). Speed control with frequency inverter can be done in 3~phase products (see BSC-F accessory)

Usage Areas

In order to increase the air quality of indoor spaces, it is used in situations where vertical shot is required under conditions where air cannot be disposed horizontally. The BRF-V roof fans operate at low volume with an external rotor motor. It is used on the roofs of the places where the air is to be refreshed and the chimneys on the bathroom and wc roofs of the buildings which are opened to the common shaft.

Technical Drawing and Tables

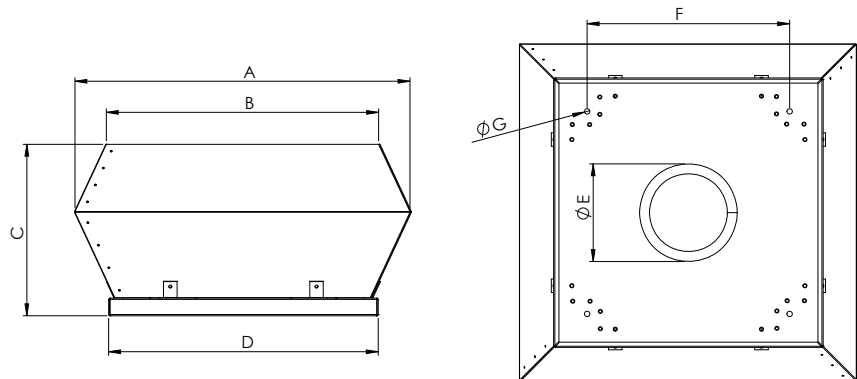

TYPE	A	B	C	D	E	F	G
BRF-V 225	350	295	190	335	146	245	10
BRF-V 315	552	450	330	505	185	450	10
BRF-V 355	745	607	385	595	234	450	10
BRF-V 400	745	607	385	595	270	450	10
BRF-V 450	900	742	512	665	282	630	10
BRF-V 500	900	742	512	665	320	630	12
BRF-V 560	1190	955	595	946	360	740	12

Dimensions are in (mm)

TYPE	VOLTAGE	FREQUENCY	POWER	CURRENT	CAPACITOR	SPEED	AIR FLOW	SOUND PRESSURE	INSULATION CLASS	PROTECTION CLASS	WEIGHT
	V	Hz	W	(A)	(µF)	r.p.m	m ³ /h	dB(A)	Ins.cl.	IP	kg
BRF-V 225	230	50/60	160/220	0,71/0,99	6	2650	850	43-35	B	44	7
BRF-V 315	230	50/60	150/175	0,92/0,85	6	1450/1725	1900/2260	45-37	F	44	22
BRF-V 355	230	50/60	200/255	1,1/1,25	8	1400/1600	2850/3250	46-38	F	44	34
BRF-V 400	230	50/60	310/460	1,56/2,27	10	1380/1560	4000/4521	47-39	F	44	39
BRF-V 450	230	50/60	425/630	2,17/3,15	10	1390/1550	5400/6000	50-42	F	44	51
BRF-V 500	380 Δ/Y	50	960/620	2/1,1	-	1400/1050	7600/5700	52-44	F	44	60
BRF-V 560	380 Δ/Y	50	1515/870	2,9/1,7	-	1250/950	9600/7300	60-52	F	44	99

The sound level is measured at a distance of 4-10 m in open field condition.

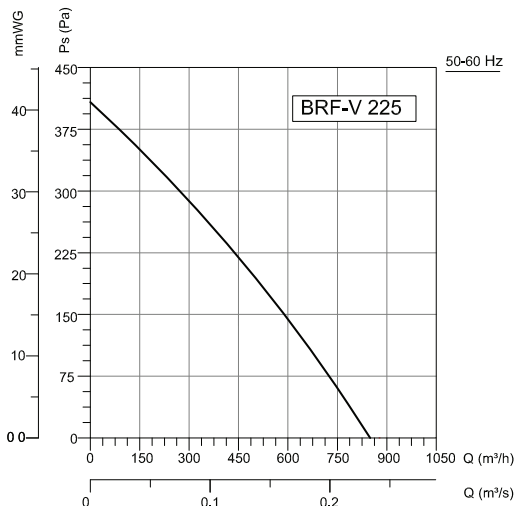

Frequency	Tot	63	125	250	500	1000	2000	4000	8000	Hz
L _{WA} Inlet	65	36	54	58	60	59	56	51	44	dB(A)
L _{WA} Surrounding	66	37	53	59	61	60	57	52	45	dB(A)

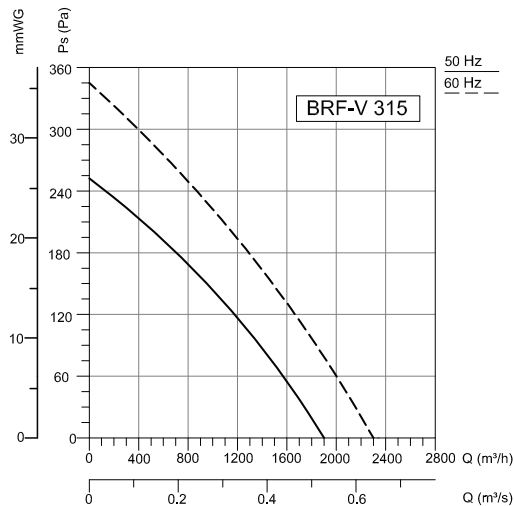

Frequency	Tot	63	125	250	500	1000	2000	4000	8000	Hz
L _{WA} Inlet	68	55	57	61	63	62	59	54	47	dB(A)
L _{WA} Surrounding	70	57	59	63	65	64	61	56	49	dB(A)

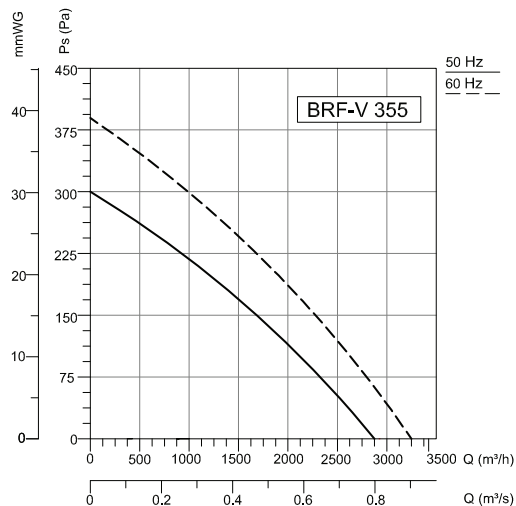

Frequency	Tot	63	125	250	500	1000	2000	4000	8000	Hz
L _{WA} Inlet	67	54	56	60	62	61	58	53	46	dB(A)
L _{WA} Surrounding	69	56	58	62	64	63	60	55	48	dB(A)

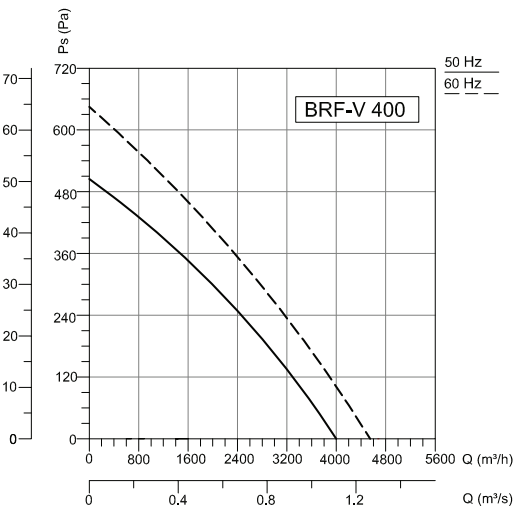

Frequency	Tot	63	125	250	500	1000	2000	4000	8000	Hz
L _{WA} Inlet	71	39	58	66	61	67	54	50	47	dB(A)
L _{WA} Surrounding	70	43	63	62	66	64	57	52	48	dB(A)

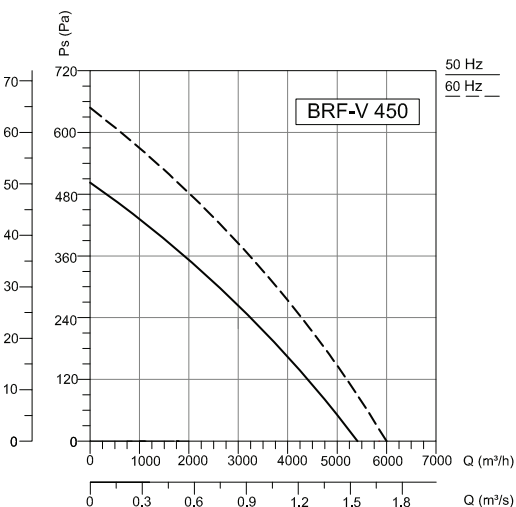

Frequency	Tot	63	125	250	500	1000	2000	4000	8000	Hz
L _{WA} Inlet	68	51	56	63	62	59	57	52	53	dB(A)
L _{WA} Surrounding	73	43	62	64	68	67	62	57	55	dB(A)

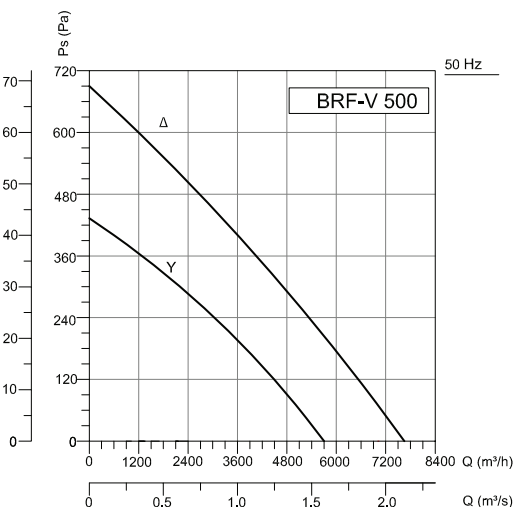

Frequency	Tot	63	125	250	500	1000	2000	4000	8000	Hz
L _{WA} Inlet	73	46	60	70	68	64	61	56	54	dB(A)
L _{WA} Surrounding	75	44	62	66	71	68	66	59	55	dB(A)

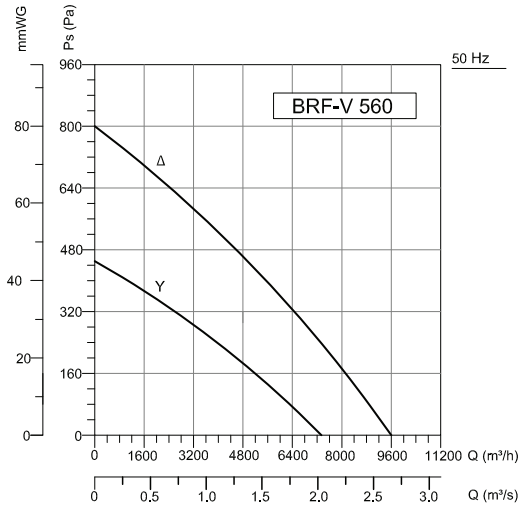

Frequency	Tot	63	125	250	500	1000	2000	4000	8000	Hz
L _{WA} Inlet	81	54	70	74	76	75	71	66	59	dB(A)
L _{WA} Surrounding	83	54	71	75	77	78	74	68	61	dB(A)

Accessories



BSC BSC-F BYF BYKS BYH

